

ingenuity™

Please read the following instructions carefully.
Keep this instruction manual for future reference.

No tools required.

Keep small parts away from children.

⚠ WARNING

**Adult assembly required.
Exercise care when unpacking
and assembling product.**

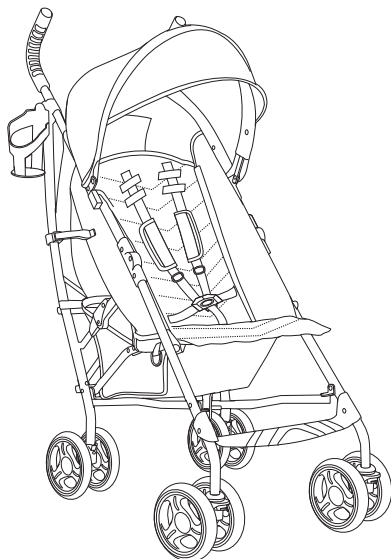

3Dlite™

convenience stroller

INSTRUCTION MANUAL

MANUFACTURED FOR • FABRIQUÉ POUR **kids2™ kidsII®** ©2024 KIDS2, LLC. www.kids2.com/help

KIDS2, LLC. ATLANTA, GA USA 30305 • 1-800-230-8190

IMPORTED BY • IMPORTÉ PAR

KIDS2 CANADA CO. PO BOX 54059, RPA LAWRENCE PLAZA, TORONTO, ON. M6A 3B7

KIDS2 AUSTRALIA PTY LIMITED CASTLE HILL, NSW AUSTRALIA 2154 • (02) 9894-1855

KIDS2 JAPAN K.K. c/o ARK Outsourcing KK 4-3-5-704, Ebisu, Shibuya-ku, Tokyo, Japan 150-0013 • (03) 5322-6081

KIDS2 UK LTD. GROUND FLOOR, SUITE A1A, BREAKSPEAR PARK, BREAKSPEAR WAY, HEMEL HEMPSTEAD, HP2 4TZ • +44 01582 816 080

KIDS2 EUROPE BV 5 KEIZERS, KEIZERSGRACHT 287, 1016 ED AMSTERDAM, NETHERLANDS • +31 20 2410934

KIDS2 US MÉXICO S.A. DE C.V. • (55) 5292-8488

MADE IN CHINA • HECHO EN CHINA • FABRIQUÉ EN CHINE

Colors and styles may vary.

WARNING

- Read and follow all warnings and instructions. Failure to do so could result in serious injury or death.
- Maximum weight and height of child: 50 lbs. (22,7 kg), 43 in. (109cm)
- NEVER leave child unattended.
- Avoid serious injury from falling or sliding out. ALWAYS use safety harness.
- When making adjustments to the product ALWAYS ENSURE that all parts of a child's body are clear of any moving parts of the product.
- Care must be taken when folding and unfolding the product to prevent finger entrapment.
- DO NOT carry additional children, goods or accessories in or on this product except as recommended in the manufacturer's instructions.
- TO AVOID INJURY TO YOUR CHILD, DO NOT USE STORAGE BASKET AS A CHILD CARRIER.
- DO NOT hang items on handle bar or place them on the canopy, as they can tip stroller over and injure child.
- DO NOT OVERLOAD STORAGE BASKET. MAXIMUM 10 lbs. (4,5 kg).
- This product may become unstable if a parcel bag, other than the one recommended is used.
- MAXIMUM weight of the cup holder is 1lb (0.45kg). Excessive weight may cause stroller to become unstable or tip over.
- DO NOT place hot liquids in the cup holder. Spills can burn your child.
- Do not carry or roll stroller on stairs or escalators with child in it.
- Do not use the stroller if any part is lost or damaged.

CARE AND MAINTENANCE

- Clean minor stains on fabric with cold water and mild soap.
- Clean plastic and metal surfaces with a soft damp cloth. Air dry. Do not use abrasive cleaners or solvents. Do not use bleach.
- Check seat pad harness and crotch straps weekly to ensure they are properly secured to frame.

components:

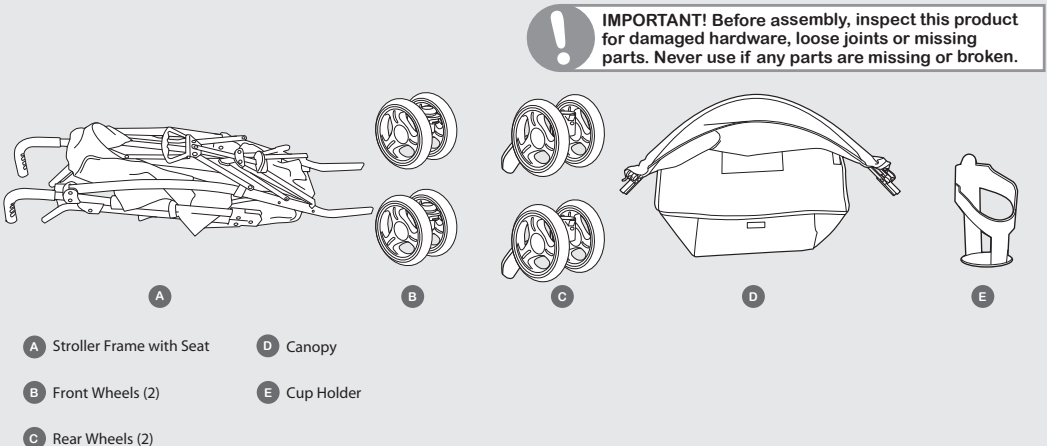

features:

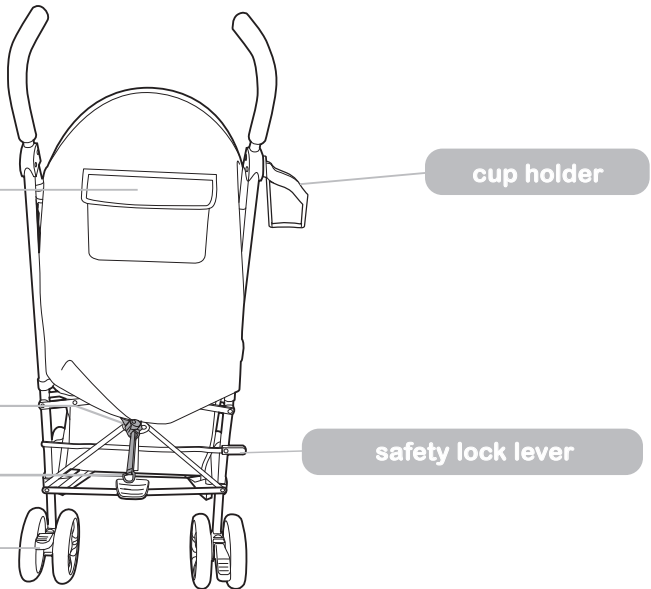
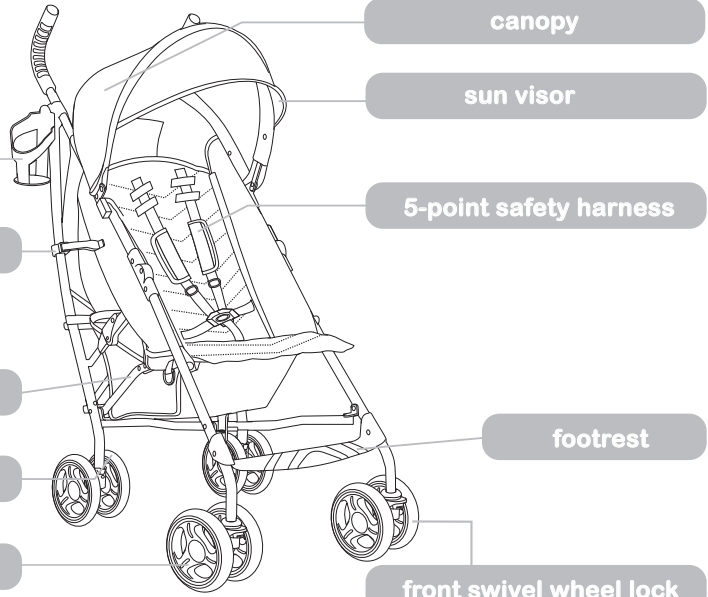

assembly instructions:

Before unfolding, you will need to cut the plastic zip-tie holding the stroller frame together.

- 1 lift up fold-lock to release
- 2 lift up to unfold

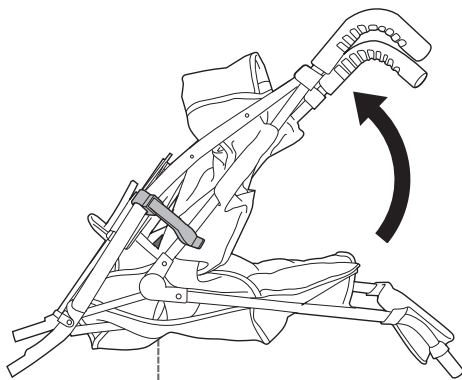
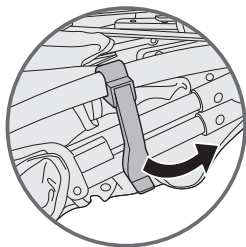

! NOTE: When opening the stroller, ensure that your child, or other children, are at a safe distance.

- 3 press the lock-out bar down with your foot

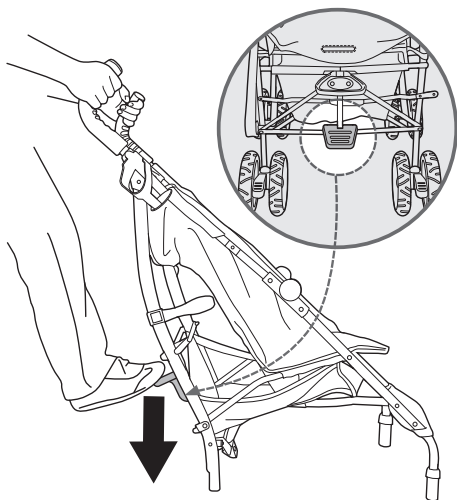

! NOTE: Before use, ensure that the stroller locking mechanism is secured.

- 4 align rear wheels and push onto frame

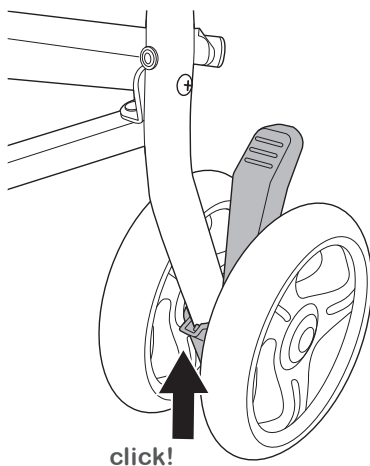

! Tug on each wheel to ensure they are both securely attached.

assembly instructions:

- 5** align front wheels, making sure locations of lock pedal is up, and push onto frame

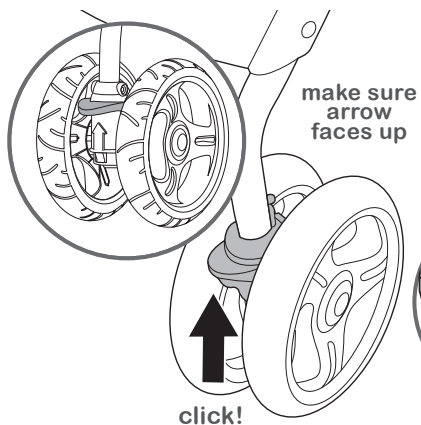

- 6** line up cupholder with mounting post and push down

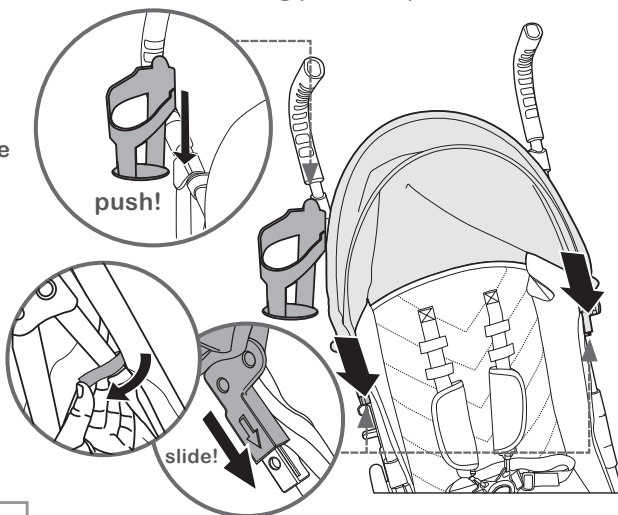

- 7** slide canopy onto frame mounts and attach velcro (both sides)



Tug on each wheel to ensure they are both securely attached.

locking & unlocking the wheels:

rear wheels - brake

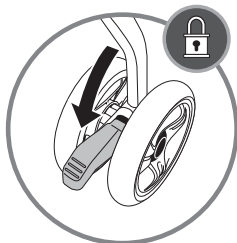

press rear brake lever down to lock brake

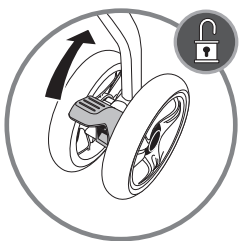

press rear brake lever up to unlock brake

front wheels

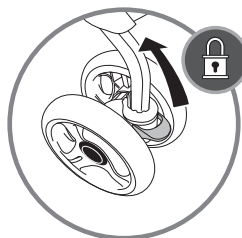

press front wheel lock up to lock swivel

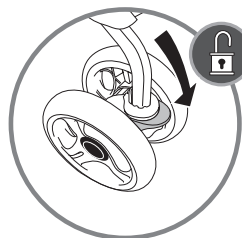

press front wheel lock down to unlock swivel

reclining the seat:

- 1 push seat forward to raise seat upright



- 2 to lower backrest press lever, lower backrest to desired position and lock in place

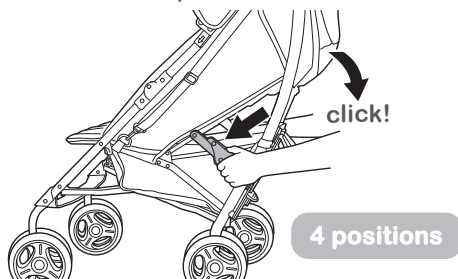

adjusting the shoulder harness position:

remove harness pads, unlock restraint, slide shoulder harness out of slot, and adjust harness position as shown below and reinstall harness pads.

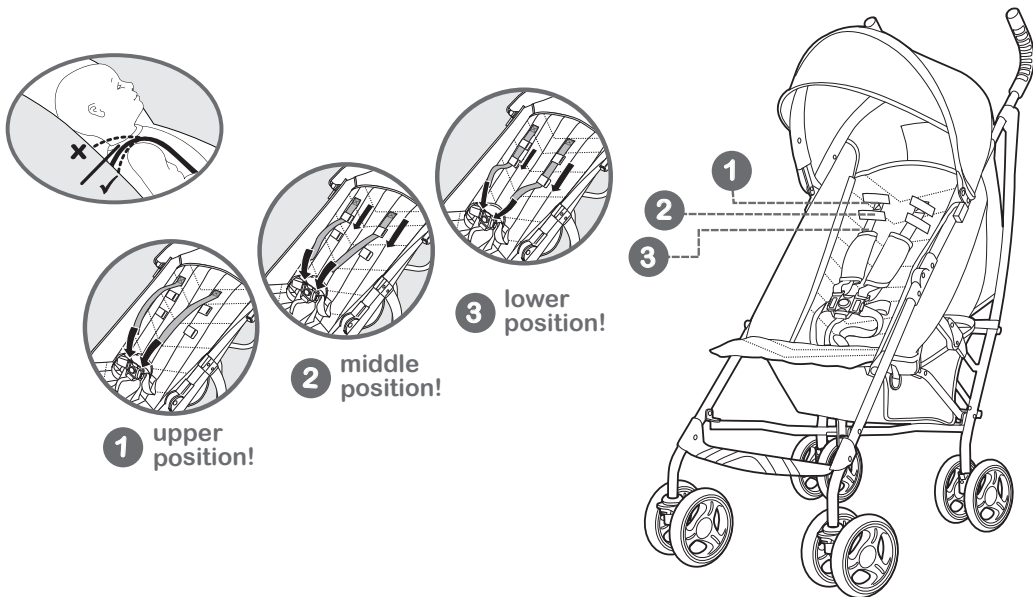

tightening and loosening the child restraint:

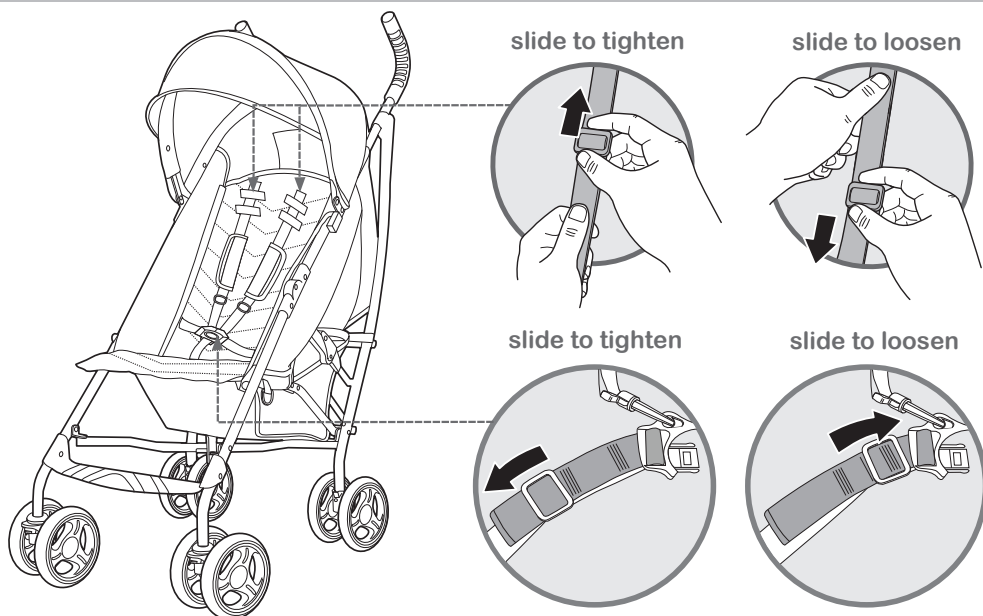

locking/unlocking the child restraint:

using the sun visor:

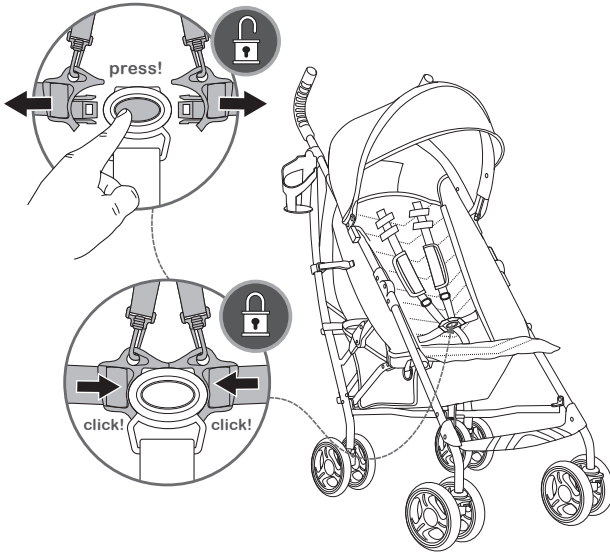

flip visor out as shown,
tuck back under when not in use

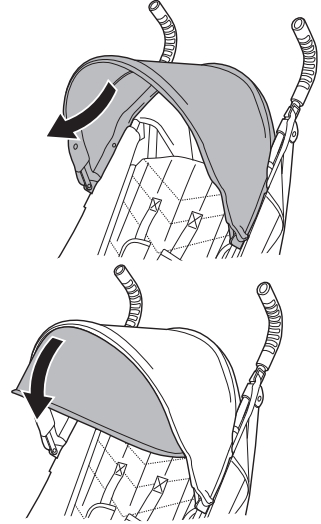

folding your stroller

1 close canopy

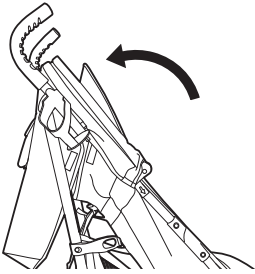

2 push foot pedal up then step down
on lock lever as shown.

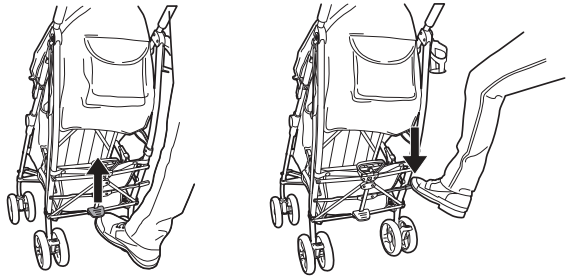

3 push forward
and down

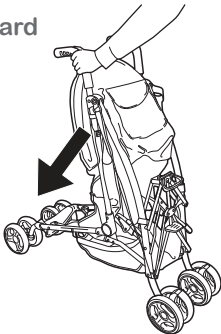

4 done! your stroller
is ready for
storage.

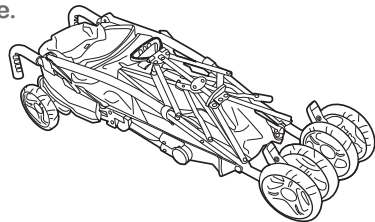

ingenuity™

Por favor, lea detenidamente las siguientes instrucciones. Conserve este manual de instrucciones para futuras consultas. No requiere herramientas. Mantenga las piezas pequeñas fuera del alcance de los niños.

⚠ ADVERTENCIA
Requiere montaje por parte de un adulto. Tenga cuidado al desembalar y montar el producto.

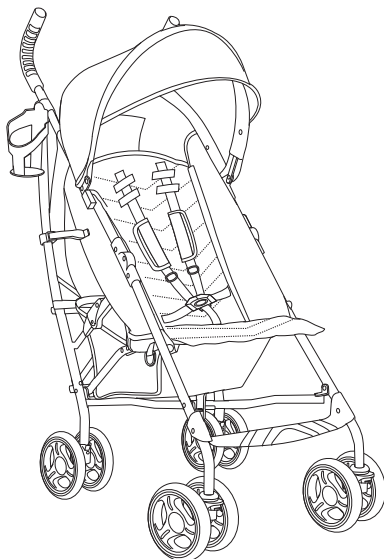

3Dlite™

Cochechito Práctico

MANUAL DE INSTRUCCIONES

MANUFACTURED FOR • FABRIQUÉ POUR **kids2™** & **Kids II®** ©2024 KIDS2, LLC. www.kids2.com/help

KIDS2, LLC. ATLANTA, GA USA 30305 • 1-800-230-8190

IMPORTED BY • IMPORTÉ PAR

KIDS2 CANADA CO. PO BOX 54059, RPA LAWRENCE PLAZA, TORONTO, ON. M6A 3B7

KIDS2 AUSTRALIA PTY LIMITED CASTLE HILL, NSW AUSTRALIA 2154 • (02) 9894-1855

KIDS2 JAPAN K.K. c/o ARK Outsourcing KK 4-3-5-704, Ebisu, Shibuya-ku, Tokyo, Japan 150-0013 • (03) 5322-6081

KIDS2 UK LTD. GROUND FLOOR, SUITE A1A, BREAKSPEAR PARK, BREAKSPEAR WAY, HEMEL HEMPSTEAD, HP2 4TZ • +44 01582 816 080

KIDS2 EUROPE BV 5 KEIZERS, KEIZERSGRACHT 287, 1016 ED AMSTERDAM, NETHERLANDS • +31 20 2410934

KIDS2 US MÉXICO S.A. DE C.V. • (55) 5292-8488

MADE IN CHINA • HECHO EN CHINA • FABRIQUÉ EN CHINE

Los colores y modelos pueden variar.

! ADVERTENCIA

- Lea y siga todas las advertencias e instrucciones. De lo contrario, podrían producirse lesiones graves o incluso la muerte.
- Peso y altura máximos del niño: 22,7 kg (50 lbs.), 109 cm (43 in.).
- NUNCA deje al niño desatendido.
- Evite lesiones graves por caída o deslizamiento. Utilice SIEMPRE el arnés de seguridad.
- Cuando realice ajustes en el producto, ASEGÚRESE SIEMPRE de que todas las partes del cuerpo del niño están alejadas de cualquier parte móvil del producto.
- Tenga cuidado al plegar y desplegar el producto para evitar pillarse los dedos.
- NO transporte niños, artículos o accesorios adicionales en o sobre este producto, excepto como se recomienda en las instrucciones del fabricante.
- PARA EVITAR QUE SU HIJO SUFRA LESIONES, NO UTILICE LA CESTA PORTAOBJETOS COMO PORTABEBÉS.
- NO cuelgue objetos del manillar ni los coloque en la capota, ya que podrían volcar el cochecito y lesionar al niño.
- NO SOBRECARGUE LA CESTA PORTAOBJETOS. PESO MÁXIMO DE 4,5 kg (10 libras).
- Este producto puede volverse inestable si se utiliza una bolsa de transporte distinta a la recomendada.
- MÁXIMO de la bandeja de aperitivos es de 0.45 kg (1lb), el peso máximo del portavasos es de 0.45 kg (1lb).
Un peso excesivo puede provocar que el cochecito se vuelva inestable o vuelque.
- NO coloque líquidos calientes en el portavasos. Los derrames podrían quemar al niño.
- No transporte ni haga rodar el cochecito por escaleras o escaleras mecánicas con el niño dentro.
- No utilice el cochecito si se ha perdido o dañado alguna pieza.

CUIDADO Y MANTENIMIENTO

- Limpie las manchas leves en la tela con agua fría y jabón neutro.
- Limpie las superficies de plástico y metal con un paño suave humedecido. Deje secar al aire. No utilice limpiadores abrasivos ni disolventes. No utilice lejía.
- Compruebe semanalmente el arnés del cojín del asiento y las correas de la entrepierna para asegurarse de que están bien sujetas al armazón.

elementos:



IMPORTANTE: Antes del montaje, inspeccione este producto para comprobar que no haya herrajes dañados, juntas sueltas o piezas que falten. No lo utilice nunca si falta alguna pieza o está rota.

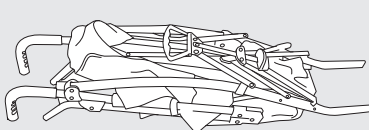

A

A Armazón del cochecito con asiento



B

B Ruedas delanteras (2)



C

C Ruedas traseras (2)

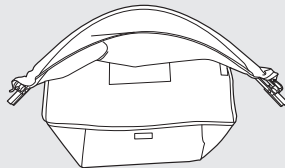

D

D Capota



E

E Portavasos

características:

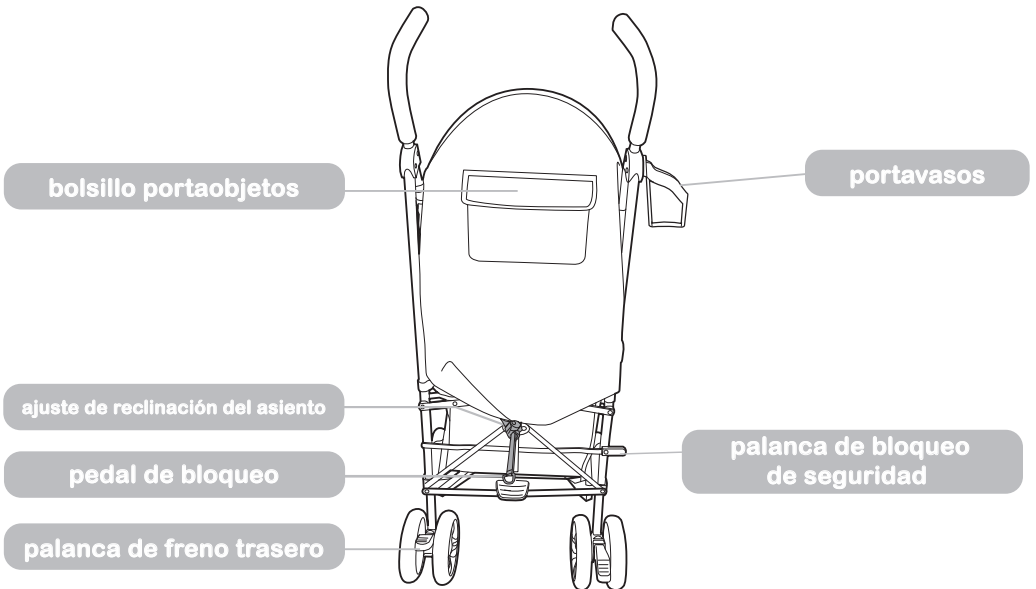
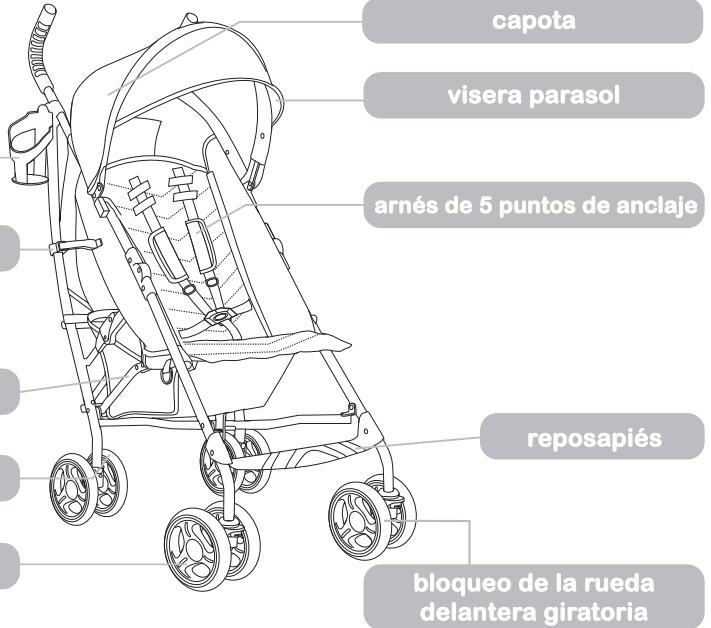

instrucciones de montaje:

Antes de desplegarlo, tendrás que cortar la cremallera de plástico que mantiene unida la estructura del cochecito.

- 1 levante el cierre para desbloquearlo
- 2 levántelo para desplegarlo.

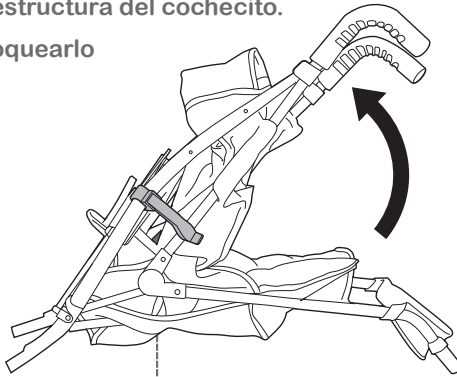
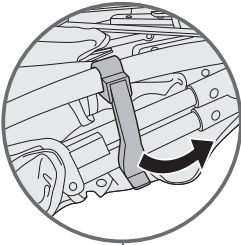

NOTA: Al abrir el cochecito, asegúrese de que su hijo u otros niños se encuentran a una distancia segura.

- 3 presione la barra de bloqueo hacia abajo con el pie

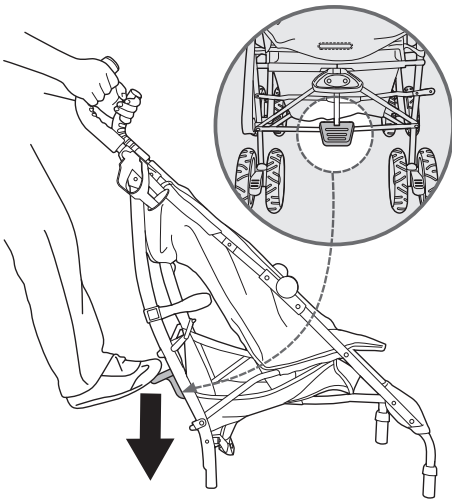

- 4 alinee las ruedas traseras y empújelas hacia el aramzón del cochecito

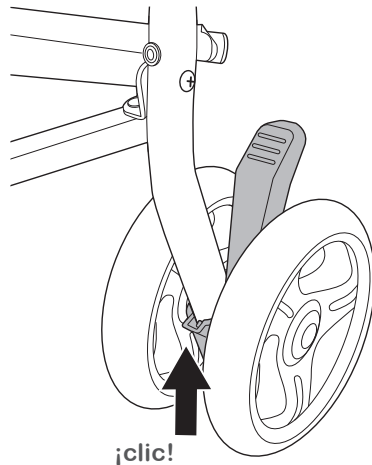

NOTA: Antes de utilizarlo, asegúrese de que el mecanismo de bloqueo del cochecito está bien sujeto.



Tire de cada rueda para asegurarse de que están bien sujetas.

instrucciones de montaje:

- 5** alinee las ruedas delanteras, asegurándose de que la posición del pedal de bloqueo está hacia arriba, y empújelas hacia el armazón del cochecito

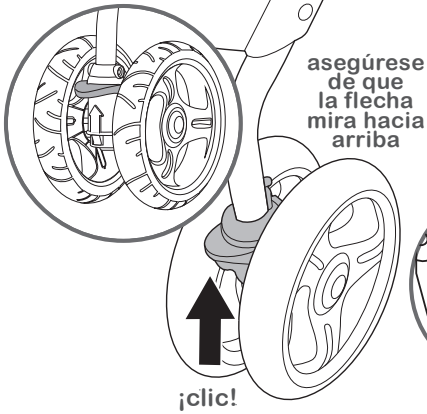

- 6** alinee el portavasos con el poste de montaje y empuje hacia abajo

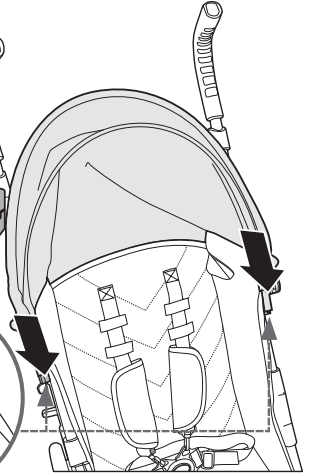
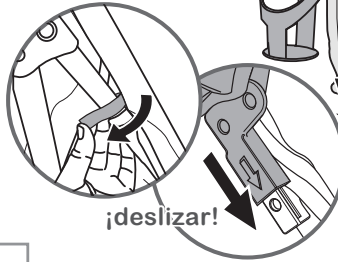
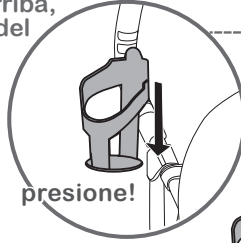

- 7** deslice la capota sobre los soportes del armazón y fije el velcro (a ambos lados)



Tire de cada rueda para asegurarse de que están bien sujetas.

bloqueo y desbloqueo de las ruedas:

ruedas traseras - freno

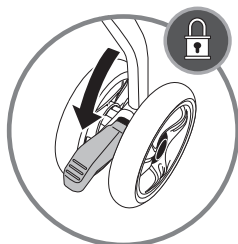

presione la palanca del freno trasero hacia abajo para bloquear el freno

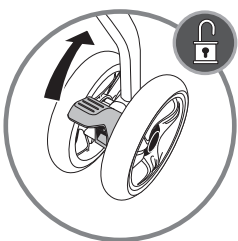

presione la palanca del freno trasero hacia arriba para desbloquear el freno

ruedas delanteras

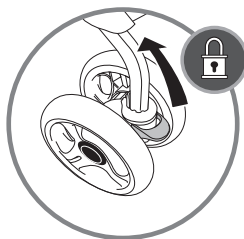

presione el bloqueo de la rueda delantera hacia arriba para bloquear el pivote

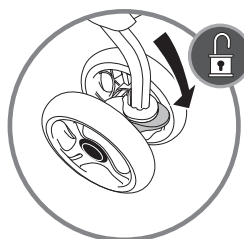

presione el bloqueo de la rueda delantera hacia abajo para desbloquear el pivote

reclinación del asiento:

- 1 empuje el asiento para levantarlo



- 2 para bajar el respaldo presione la palanca, baje el respaldo hasta la posición deseada y bloquéelo en su sitio

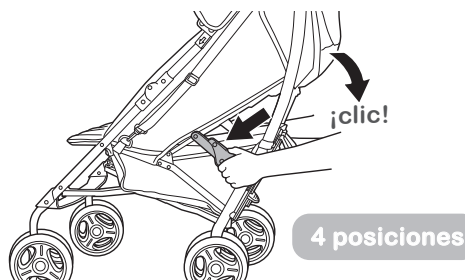

ajuste de la posición del arnés de hombros:

retire las almohadillas del arnés, desbloquee el sistema de retención, deslice el arnés de hombro fuera de la ranura y ajuste la posición del arnés como se muestra a continuación y vuelva a instalar las almohadillas del arnés.

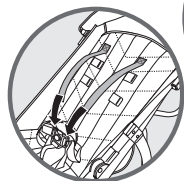
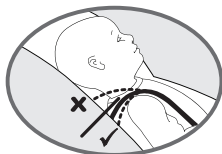

1 posición alta

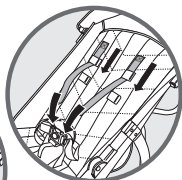

2 posición media

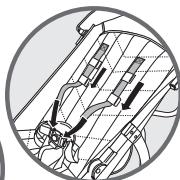

3 posición baja

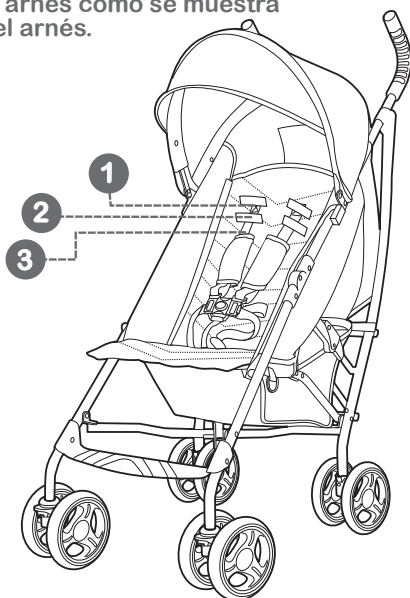

apretar y aflojar el sistema de retención infantil:

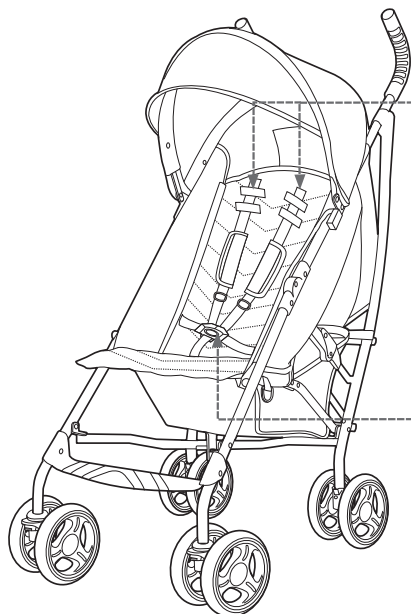

deslice para apretar

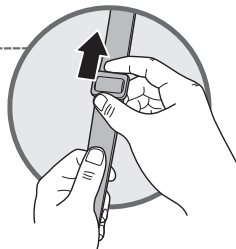

deslice para aflojar

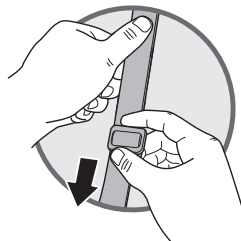

deslice para apretar

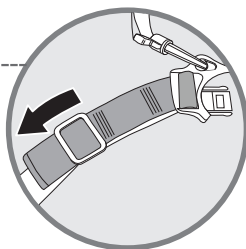

deslice para aflojar

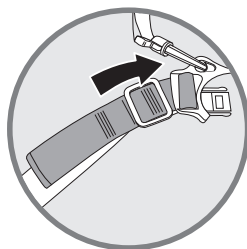

bloqueo/desbloqueo del sistema de retención infantil:

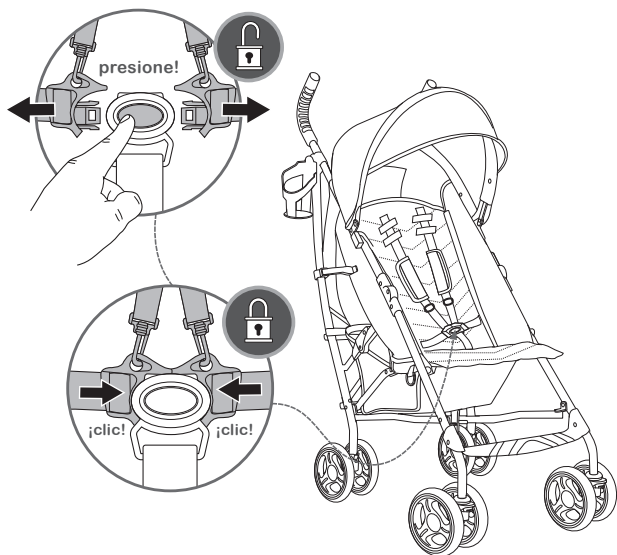

uso de la visera parasol:

despliegue la visera como se muestra, vuelva a meterla debajo cuando no la utilice

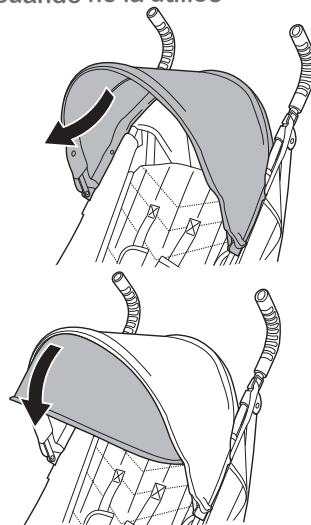

cómo plegar el cochecito

1 cierre la capota

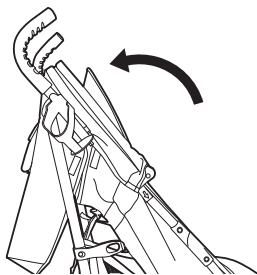

2 empuje el pedal hacia arriba y luego baje la palanca de bloqueo como se muestra en la imagen.

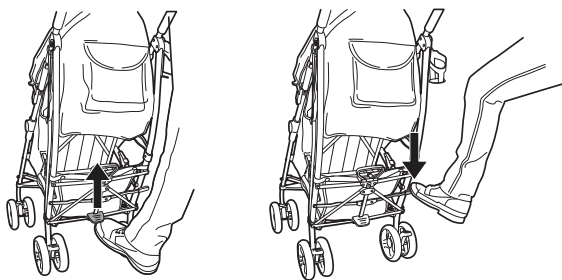

3 empuje hacia delante y hacia abajo

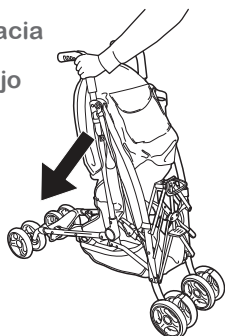

4 ¡listo! su cochecito está listo para ser guardado

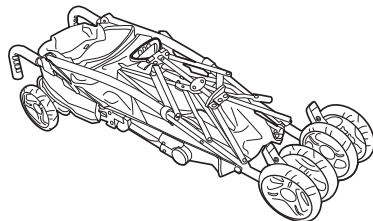

ingenuity™

Veillez lire attentivement les instructions suivantes.
Conservez cette notice pour toute
consultation ultérieure. Montage sans outils.
Ne laissez-pas de petites pièces à portée des enfants.

⚠ MISE EN GARDE
Montage réalisé par un adulte.
Faire attention pendant
le déballage

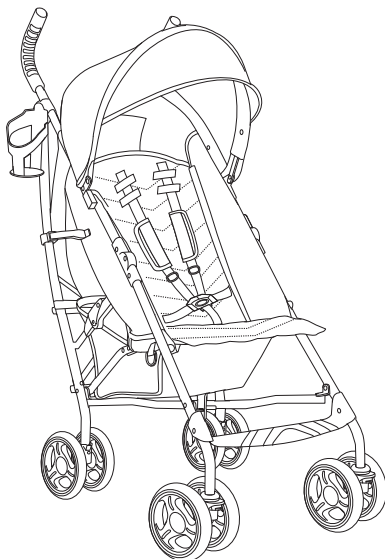

3Dlite™

Poussette Pratique

MANUEL D'INSTRUCTION

MANUFACTURED FOR • FABRIQUÉ POUR **kids2™ kidsII®** ©2024 KIDS2, LLC. www.kids2.com/help

KIDS2, LLC. ATLANTA, GA USA 30305 • 1-800-230-8190

IMPORTED BY • IMPORTÉ PAR

KIDS2 CANADA CO. PO BOX 54059, RPA LAWRENCE PLAZA, TORONTO, ON. M6A 3B7

KIDS2 AUSTRALIA PTY LIMITED CASTLE HILL, NSW AUSTRALIA 2154 • (02) 9894-1855

KIDS2 JAPAN K.K. c/o ARK Outsourcing KK 4-3-5-704, Ebisu, Shibuya-ku, Tokyo, Japan 150-0013 • (03) 5322-6081

KIDS2 UK LTD. GROUND FLOOR, SUITE A1A, BREAKSPEAR PARK, BREAKSPEAR WAY, HEMEL HEMPSTEAD, HP2 4TZ • +44 01582 816 080

KIDS2 EUROPE BV 5 KEIZERS, KEIZERSGRACHT 287, 1016 ED AMSTERDAM, NETHERLANDS • +31 20 2410934

KIDS2 US MÉXICO S.A. DE C.V. • (55) 5292-8488

MADE IN CHINA • HECHO EN CHINA • FABRIQUÉ EN CHINE

Les couleurs et modèles peuvent varier.

! MISE EN GARDE

- Lisez et suivez les recommandations et instructions données pour éviter les accidents graves ou morts accidentelles.
- Poids et hauteur max. de l'enfant : 50 lbs. (22,7 kg), 43 in. (109cm)
- NE JAMAIS laisser l'enfant seul.
- Evitez les accidents graves de chute ou glissades. • Utilisez TOUJOURS le harnais de sécurité.
- TOUJOURS VERIFIER que les membres de l'enfant, se trouvent hors de portée des parties amovibles du produit, quand vous faites des ajustements.
- Faites très attention quand vous pliez et dépliez ce produit, afin d'éviter de vous pincez les doigts
- NE JAMAIS transporter d'autres enfants, des marchandises ou accessoires dans ce produit ; suivez les indications du manuel d'instructions
- EVITEZ LES BLESSURES ENFANT / NE PAS UTILISER LE SAC DE RANGEMENT POUR TRANSPORTER L'ENFANT.
- N'ACCROCHEZ RIEN à la barre poignée ni à l'auvent, cela pourrait faire basculer le produit et provoquer un accident.
- NE REMPLISSEZ PAS TROP LE SAC DE RANGEMENT. MAX. 10 lbs. (4,5 kg).
- Ce produit peut devenir instable si vous utilisez un autre sac que celui recommandé.
- Poids MAXIMUM de la tablette repas : 1lb (0.45kg), Poids MAXIMUM de la porte-gobelet : 1lb (0.45kg). La poussette pourrait devenir instable ou se renverser si elle est trop chargée.
- NE REMPLISSEZ PAS le porte gobelet avec des liquides chauds pour éviter toutes brûlures enfant.
- Ne montez pas ou ne descendez pas les escaliers ou escalators en portant l'enfant dans ce produit.
- N'utilisez pas ce produit lorsque des éléments sont endommagés.

SOIN ET ENTRETIEN

- Nettoyage des petites taches sur les tissus à l'eau froide et savon doux.
- Nettoyage des surfaces plastiques et métalliques avec linge humide de savon doux. Séchage à l'air libre. Ne pas utiliser de solvants ni de nettoyeurs abrasifs. Ne pas utiliser de Javel.
- Vérifier le harnais du siège et sangles régulièrement pour une attache optimale à la structure.

composants:



Important ! Vérifiez avant assemblage qu'aucune partie n'est endommagée, manquante ou cassée ; Ne pas utiliser dans ces cas-là.

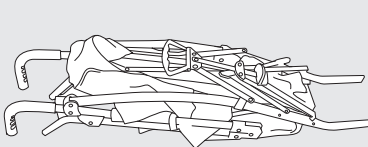

A

A Structure avec siège



B

B Roues avant (2)



C

C Roues arrières (2)

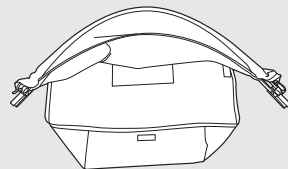

D

D Auvent



E

E Porte gobelet

Composants :

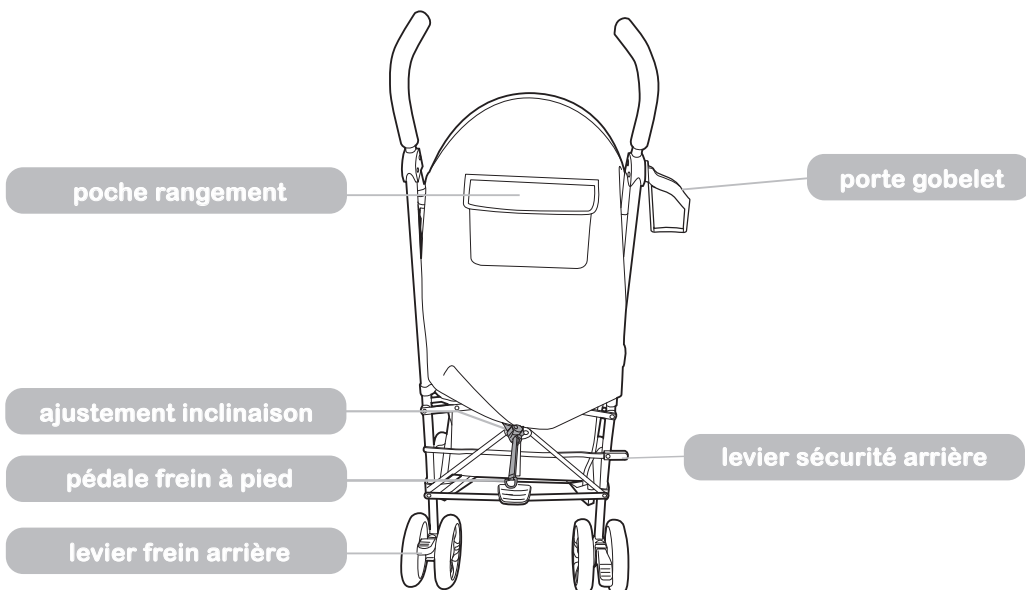
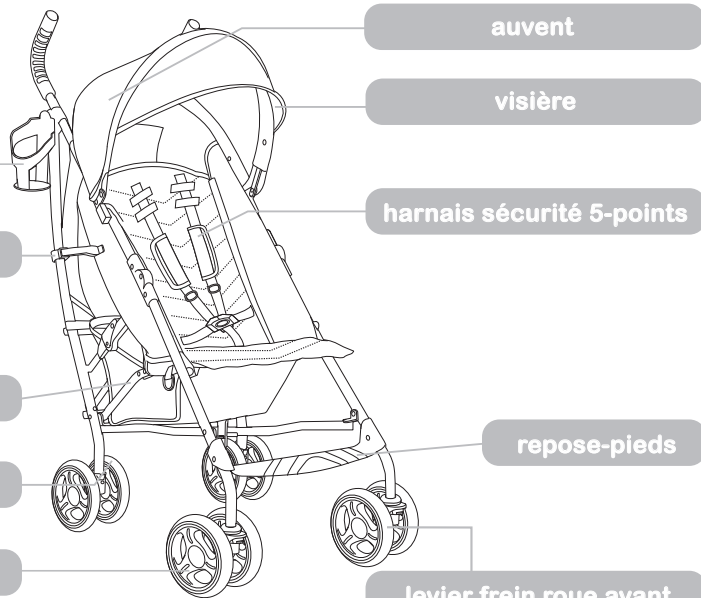

Instructions pour assemblage :

Coupez le lien plastique entourant la structure du charriot avant montage.

- 1 Soulevez la poignée de frein pour libérer le tout
- 2 Soulever pour déplier

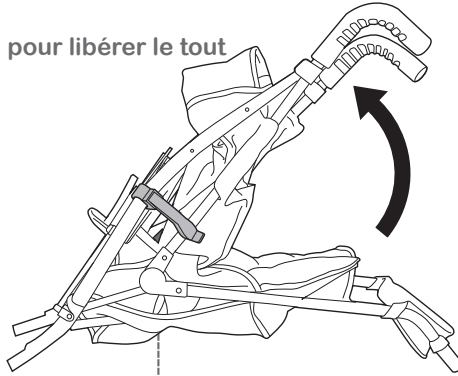
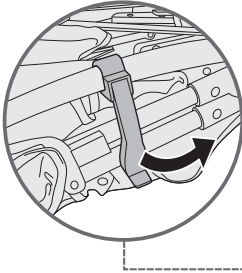

NOTE : Avant d'ouvrir le charriot, vérifiez bien que vos enfants ou d'autres enfants sont à distance de sécurité.

- 3 Appuyez sur la barre de frein avec votre pied

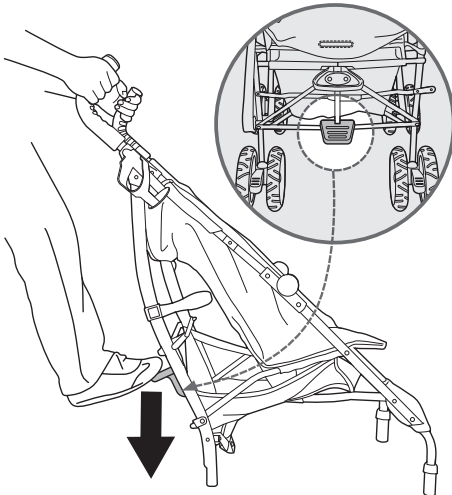

- 4 Alignez les roues arrière et poussez sur la structure

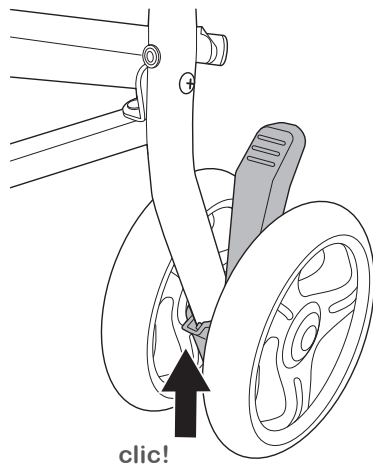

NOTE : Avant utilisation, vérifiez que le mécanisme de frein du charriot est sécurisé.



Appuyez sur chaque roue pour vous assurer qu'elles sont bien fixées.

Instructions pour assemblage :

- 5** Alignez les roues avant, vérifiez que la pédale de frein est en position haute, poussez sur la structure

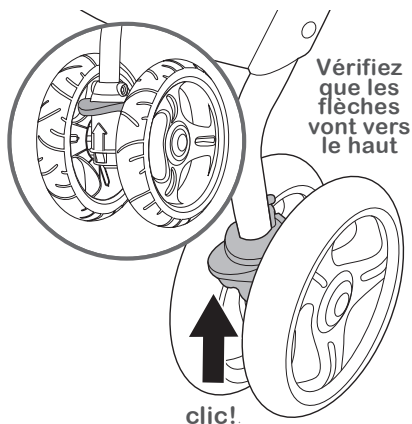

- 6** Alignez le porte gobelet avec son encoche puis appuyez vers le bas

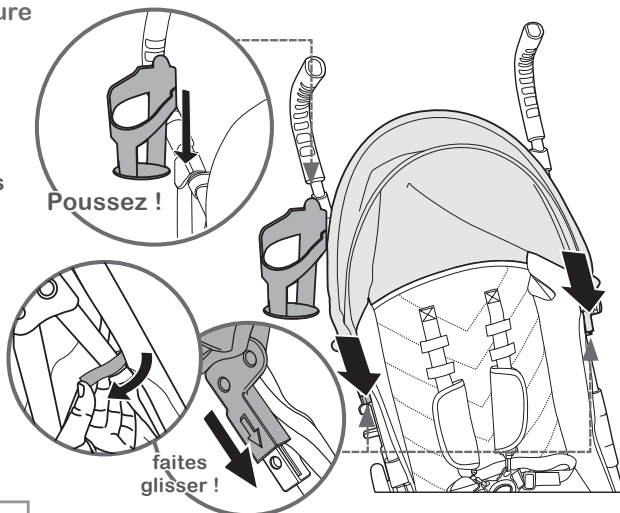

- !** Appuyez sur chaque roue pour vous assurer qu'elles sont bien fixées.

- 7** faites glisser le auvent sur les encoches structure et attachez le velcro (des deux côtés)

Verrouillage et déverrouillage des roues :

Roues avant - frein

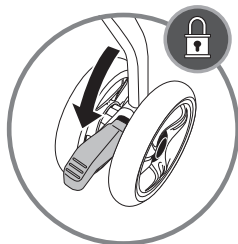

Appuyer sur le levier frein arrière pour verrouiller

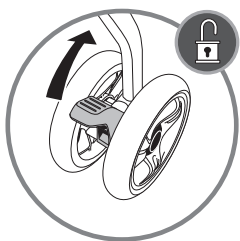

Appuyer sur le frein roue avant pour verrouiller la manette

Roues arrière

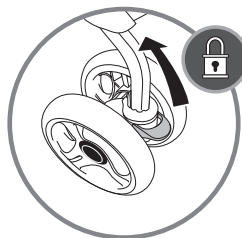

Soulever le levier frein arrière pour déverrouiller

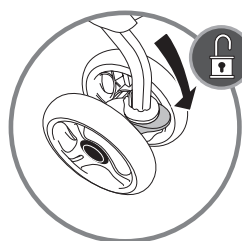

Soulever le frein roue arrière pour déverrouiller la manette

Inclinaison du siège :

- 1 poussez le siège vers l'avant pour le remettre en position verticale

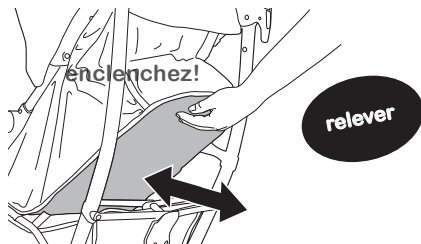

- 2 pour abaisser le dossier, appuyer sur le levier, le faire descendre jusqu'à la position désirée et le bloquer en place

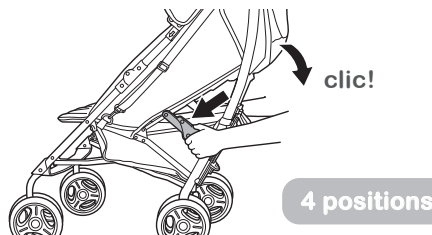

Ajuster le harnais des épaules :

Enlevez les manchons du harnais, défaites les sangles, faites glisser le harnais hors de sa protection puis ajustez la position harnais comme suit; réinstallez les manchons du harnais.

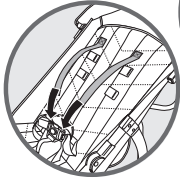
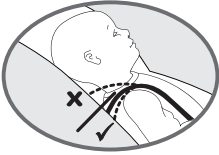

1 Position haute !

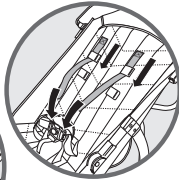

2 Position du milieu !

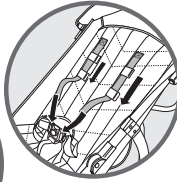

3 Position basse !



Serrer et desserrer la sangle enfant :

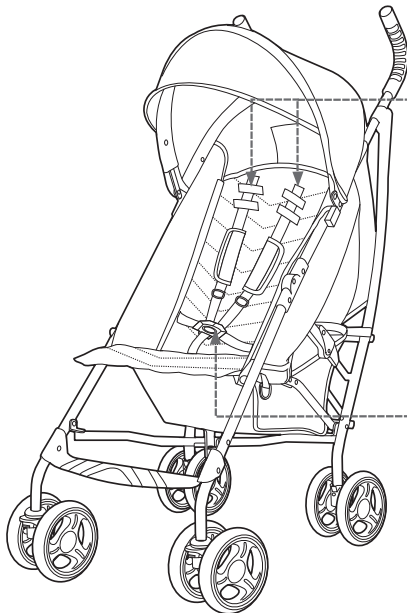

Faire glisser pour serrer

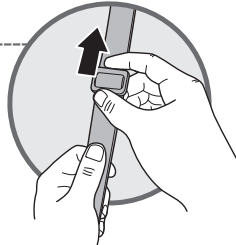

Faire glisser pour relâcher

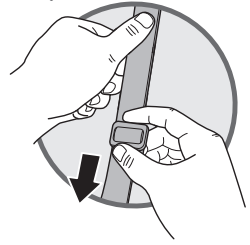

Faire glisser pour serrer

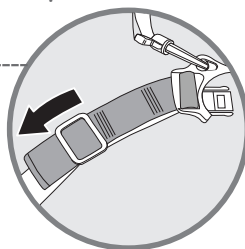

Faire glisser pour relâcher

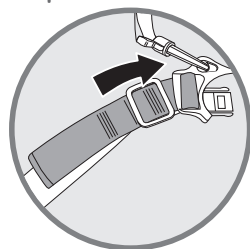

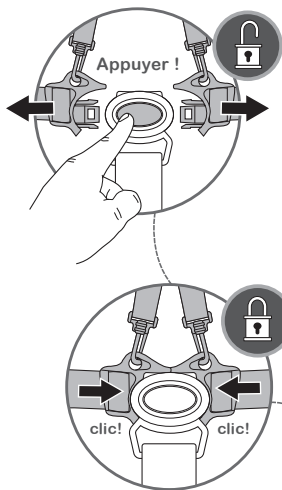

Rabaisser la visière comme suit,
Relever vers l'arrière quand inutilisé

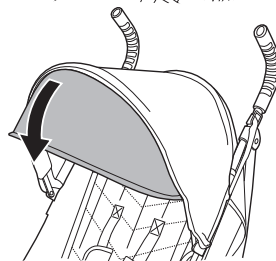
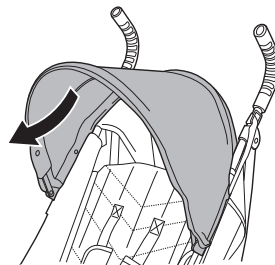

Plier le charriot

1 Fermer l'auvent

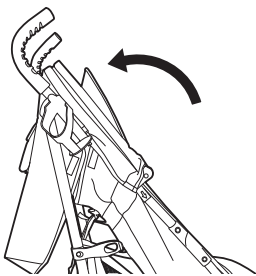

2 Relever la pédale de pied puis appuyer sur le levier frein comme suit.

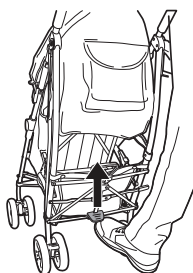

3 Pousser vers l'avant puis vers le bas

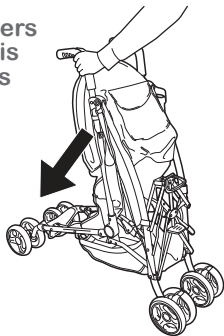

4 C'est fait ! Votre charriot est prêt à être rangé.

