

WWT
WESTINTRENDS
WWT

DESIGNED IN CALIFORNIA

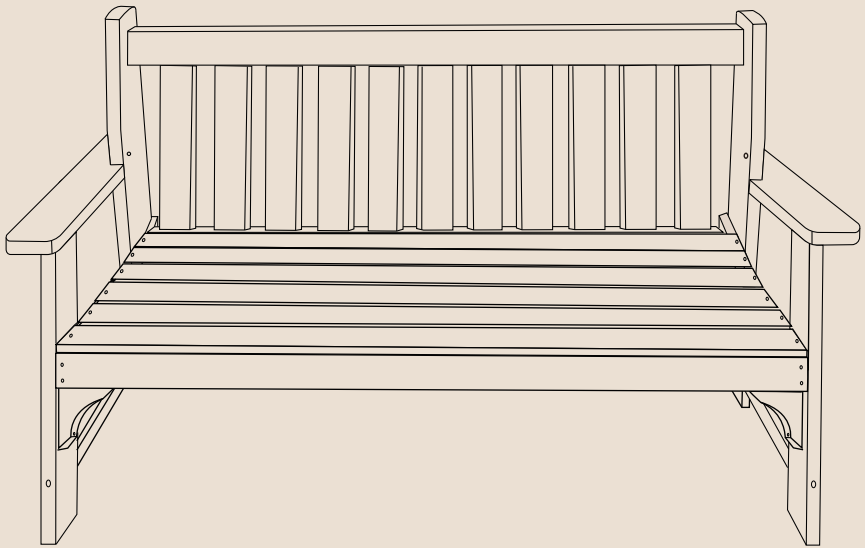

— POLY 51" GARDEN BENCH —

THANK YOU!

We appreciate you for choosing WestinTrends!

Thank you for letting WestinTrends continue to offer accessible luxury trends, inspired by everyone!

JOIN THE WESTINTRENDS COMMUNITY

Sign up here:

[***https://westintrends.com/welcome***](https://westintrends.com/welcome)



QUESTIONS OR COMMENTS?

If you have questions reach out to
[**cs@westintrends.com**](mailto:cs@westintrends.com)

FOLLOW, SHARE, & LEARN



PRODUCT REGISTRATION

[***https://westintrends.com/apps/product-registration***](https://westintrends.com/apps/product-registration)



! CARE & MAINTENANCE

Please keep these instructions for your future reference.

- Be careful when assembling to avoid damaging the plating of the surface.
- Clean the chair with lukewarm water, mild detergent & soft cloth.
- Firmly secure all bolts before use. Do not use any part of this item as a step ladder.
- Make sure that all bolts, screws, and nuts are secure every 90 days.
- Do not use or store this item in the proximity of open flame or flammable/combustible chemicals.
- Be aware that some parts are heavy and have sharp edges.
- Do not overtighten screws (insert all screws before tightening screws).

TOOLS REQUIRED



HARDWARE

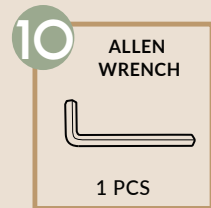
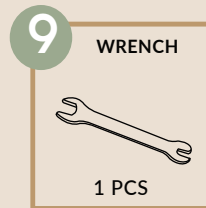
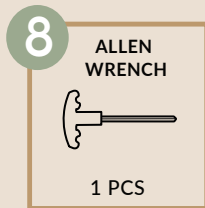
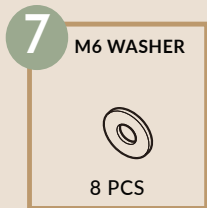
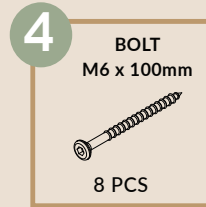
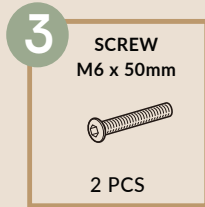
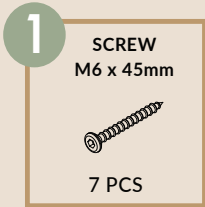

PARTS

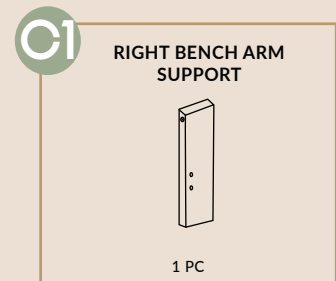
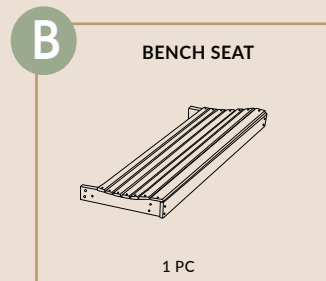
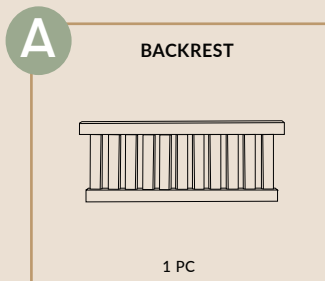

PARTS

C2

LEFT CHAIR ARM SUPPORT



1 PC

D

LEFT CHAIR ARM



1 PC

E

RIGHT CHAIR ARM

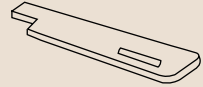

1 PC

F

LEFT CHAIR LEG

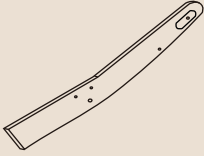

1 PC

G

RIGHT CHAIR LEG

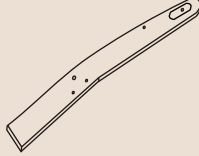

1 PC

H

CORNERBRACE

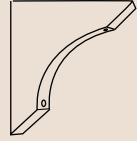

2 PC

I

LONG BRACE

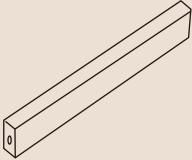

2 PC

PRODUCT ASSEMBLY - OVERALL VIEW

Look at following overall view of this bench and learn the exact position of each parts to be assembled.

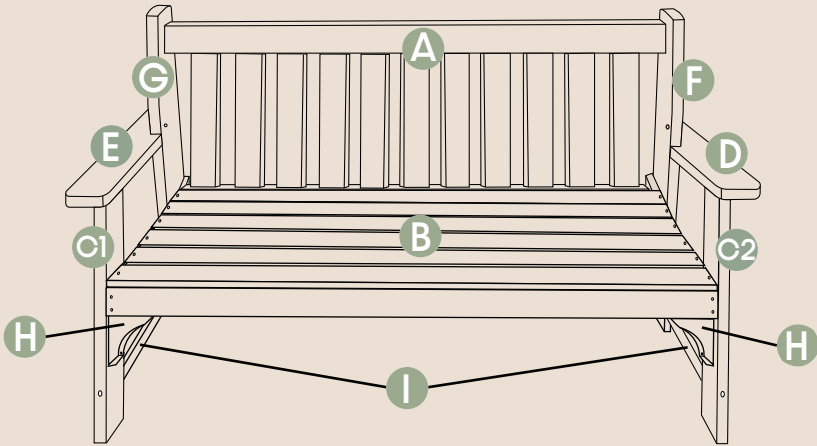

PRODUCT ASSEMBLY

1

Place **Part E Right Bench Arm** upside down on flat surface, attach **part C1 Right Bench Arm support** to **part E** with 1 pc of hardware **#4 Screw**.

Pay attention that the small hole is facing inside. Do the same to assemble another arm.

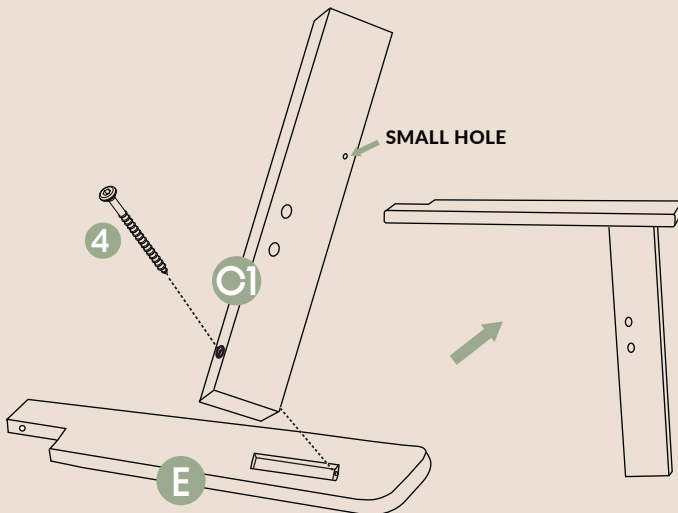

2

Attach **part G Right Bench Leg** to **part B Bench Seat** with 2 sets of hardware **#5 Bolt**, hardware **#7 Washer** and hardware **#6 Nut**.

Attach **part F Left Bench leg** to **part B Bench Seat** with 2 sets of hardware **#5 Bolt**, hardware **#7 Washer** and hardware **#6 Nut**.

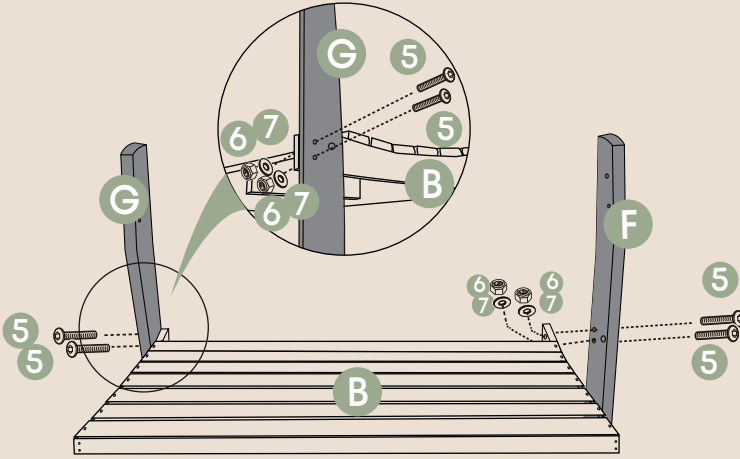

3

Attach 2 pcs of **part I Long Brace** to **part F and G Bench Legs** with 2 pcs of hardware **#4 Screw**.

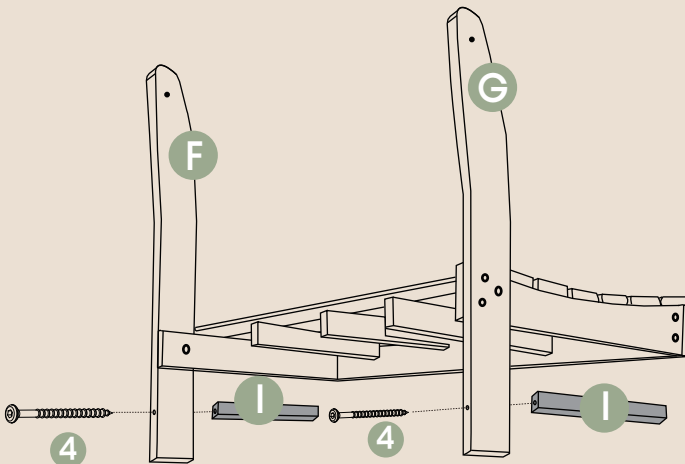

4

Attach combined **part (C1+E)** to **part G Right Bench Leg** with 1 pc of hardware **#2 Screw**. Attach the arm to **part I Long Brace** with 1 pc of hardware **#4 Screw**.

Attach it to **part B Bench Seat** with 2 sets of hardware **#5 Bolt**, hardware **#7 Washer** and hardware **#6 Nut**.

Do the same to attach combined **part (C2+D)** to the bench.

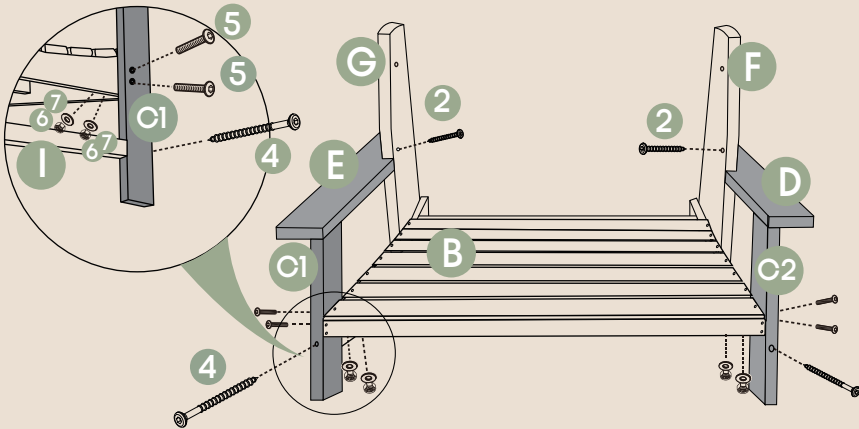

5

Attach **part A Backrest** to **part F and G Bench Legs** with 2 pcs of hardware **#3 Bolt** and 2 pcs of hardware **#4 Screw** as below.

Attach the backrest to **part B Bench Seat** with 3 pcs of hardware **#1 Screw**.

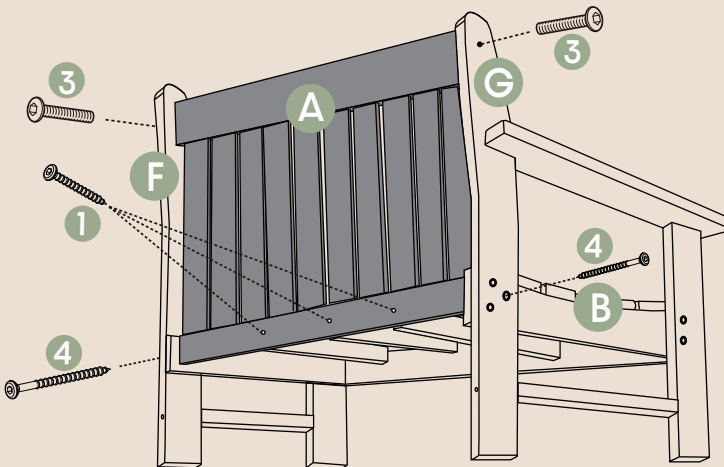

6

Attach 2 pcs of **part H Corner Brace** to the bench with 4 pcs of hardware **#1 Screw** as below.

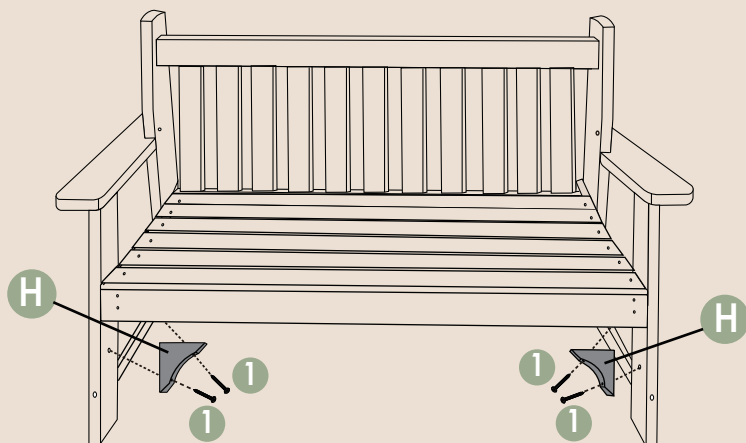

7

Tighten all the bolts and nuts again to ensure the bench is steady enough to use.

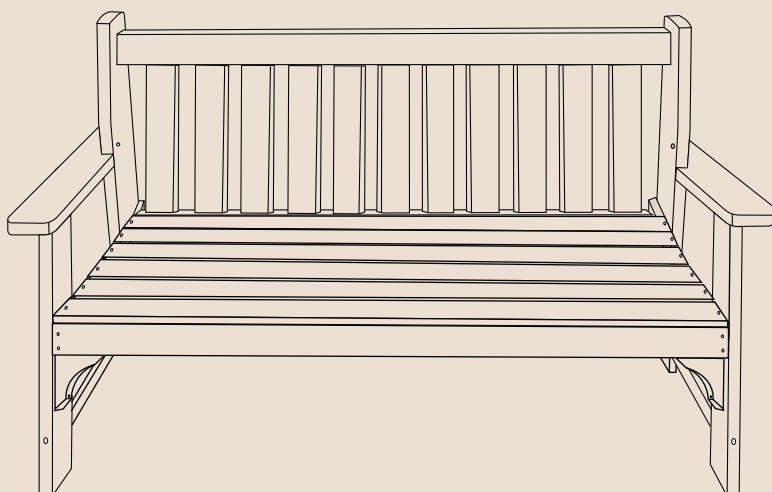

REGISTRATION & REFUND POLICY

<https://westintrends.com/apps/product-registration>



<https://westintrends.com/policies/refund-policy>



HAVING TROUBLE

- **Not sure how to assemble or missing pieces?**

Please contact our Customer Service Team for assistance at cs@westintrends.com

Have Order #, Part # or SKU ready to speed up customer service!

CLEANING TIPS

REGULAR CLEAN: Use a mixture of warm water and mild soap. Gently scrub the surface with a soft bristle brush to remove any dirt or stains.

QUICK CLEAN: You can simply wipe down the HDPE furniture with a damp cloth. The material's resilience makes it resistant to most spills and stains, ensuring a hassle-free maintenance routine.

Regular cleaning not only preserves the aesthetic appeal of your furniture but also helps extend its lifespan.

Pressure washer can be used for seriously deep-cleaning - **DO NOT exceed 1500 PSI** - this will remove debris and dirt.