

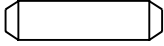





A	Dowel		2pcs
B	Screw		15pcs
C	Anchor		2pcs

1		3pcs
2		2pcs
3		2pcs



**STEP 1**

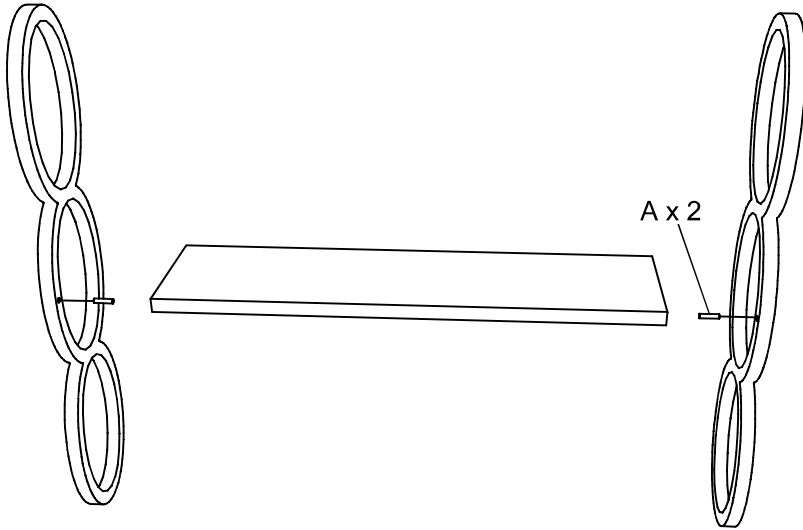
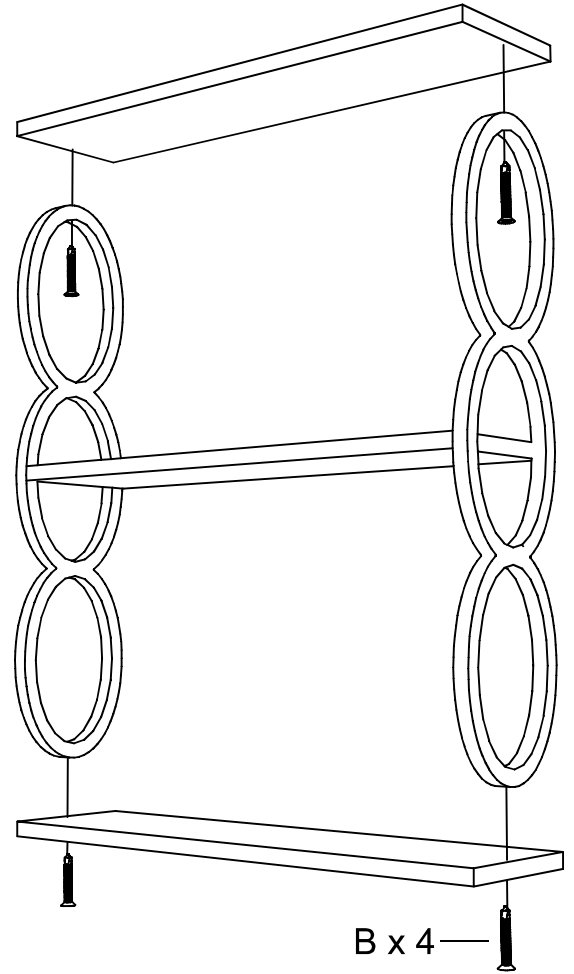

**STEP 2**

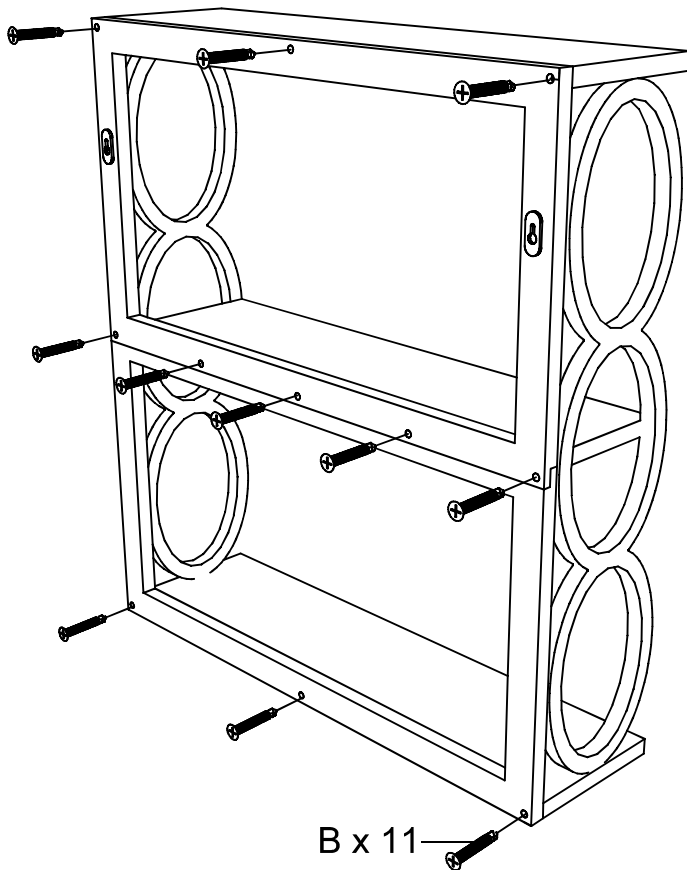

**STEP 3**