

BOSS[®]
AUDIO SYSTEMS

 **Bluetooth**[®]

BRT17SLR **USER'S MANUAL**
BLUETOOTH[®] | 17" AMPLIFIED SOUND BAR
FEATURES BUILT-IN CLASS A/B AMPLIFIER
AND MULTICOLOR ILLUMINATION OPTIONS



1

Thank you for purchasing this

BOSS®
AUDIO SYSTEMS

BRT17SLR Sound Bar

Please read through these instructions carefully so you will know how to operate your model properly.

After you have finished reading the instructions, keep this document in a safe place for future reference.

THIS PACKAGE CONTAINS

1x BRT17SLR sound bar



Mounting kit



1x Cigarette lighter plug adaptor



1x Remote control



1x User manual + 1x Warranty card

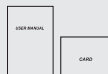

IMPORTANT

Please enter below the Serial No. which is located on the exterior of the product. Retain this information for future reference.

Model _____

Serial No. _____

Date of Purchase _____

Read and understand all instructions before you use your product. If you do not follow the instructions in this manual, we are not responsible for injury or damage resulting from improper handling. This will also void the warranty.

Important Safety Precautions

- **Be sure to observe the following guidelines:**
 - Do not increase speaker volume so high that you cannot hear what is around you.
 - Use caution or temporarily discontinue use in potentially hazardous situations.
- Do not make any adjustment on the product when driving or in other situations where distractions can be hazardous. Responsible and safe driving is your primary responsibility when operating a vehicle.
- Start volume at a low setting then gradually increase the volume until you can hear it comfortably, without sound distortion and ear discomfort.
- In the event of smoke, strange noise or odor emitted from the product or any other abnormal operational signs appearing on the product, disconnect the product from the power supply. Discontinue use and contact your dealer or our technical support. Using the product in this condition may result in permanent damage to the system.
- Servicing must only be carried out by a technician. Contact our technical support for any service question.

Installation Precautions

- **WARNING: Always consult a professional installer.**
- Installation must be performed by a professional. Contact our technical support for any installation questions.
- Observe the safety and operating instructions of the devices which are connected to the product.
- Only use attachments/accessories specified by the manufacturer for installation.
- Do not modify this product, as this affects the safety of the product. Risk of injury or damage to the product.
- Before installation, disconnect the negative terminal of the vehicle battery to prevent damage to the product, fire, and/or possible injury.

Care for Your Product

- **DO NOT** clean the product in hot weather (e.g. hot sunlight).
- **DO NOT** use abrasive or highly alkaline cleaner on the product.
- **DO NOT** use gasoline, acetone, carbon tetrachloride or other aggressive chemical solutions on the product.
- **DO NOT** scrape the product with razor blade or other sharp instrument.
- This product is water resistant. However, never submerge the product to water.
- Wash the product with lukewarm water and mild soap or detergent, using a clean sponge or soft cloth. Rinse well with clean water.

Introduction

The product is a Bluetooth speaker system which is ideal for installation in a ATV (All Terrain Vehicle) or UTV (Utility Vehicle). Through Bluetooth connection, audio can be streamed from a mobile phone to this product. Music from an external device (e.g. a USB flash memory, mobile phone or MP3 player) can also be played on this product via USB port or 3.5 mm AUX jack. You can also output audio from this product to an external amplifier or powered speakers via RCA outputs.

The product is integrated with LED lights which can be controlled via the supplied remote control.

This product is shockproof and water resistant. This product is operated with 12 V DC vehicle power supply. Never connect this product to any other voltage supply.

Product Overview

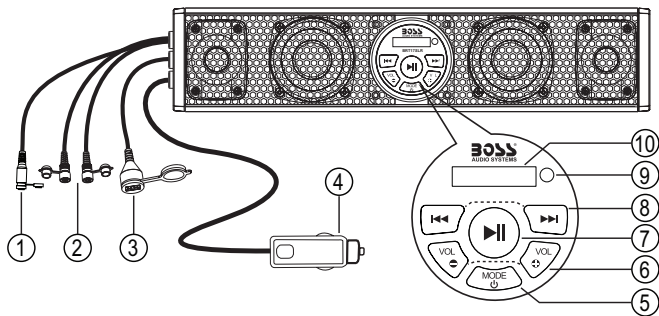

- | | |
|---|---|
| 1 3.5mm audio input jack | 6 Volume buttons |
| 2 RCA audio output sockets | 7 Start/pause/resume play button |
| 3 USB port | 8 Track selection buttons |
| 4 Vehicle cigarette lighter plug | 9 Remote sensor (aim the remote control directly at the sensor when using the remote) |
| 5 Power button (press and hold to power on or off); Mode button | 10 Display |

Mounting on ATV or UTV



Always consult technical personnel if you are in doubt about installation.

You must work with an assistant to mount the sound bar due to its heavy weight.

Use only the supplied accessory for mounting. Using other mounting methods may void the warranty.

To ensure safety of the mounted sound bar, always check the mounting conditions (e.g. mounting straps) of the sound bar before each vehicle ride.

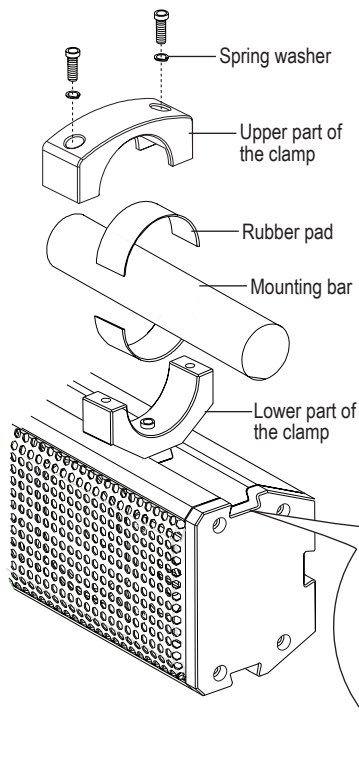

1. With correct orientation, attach a sliding block to the lower part of a clamp using a proper hex wrench (not included). Make sure not to tighten the block for subsequent insertion into the channel.
2. Find the sliding channel (groove) on the top panel of the sound bar. Correctly orient the sliding block and insert it into the channel from either end of the channel. Then slide the clamp to a proper position and tighten it with a hex wrench.
3. Attach the supplied rubber pads for secure clamping and abrasion prevention.
4. Tighten the upper clamp to the lower clamp with a hex wrench. Make sure the supplied spring washers are used to provide more stable bolt tightening against vibration.

Repeat the steps above to secure the sound bar with the other clamp.

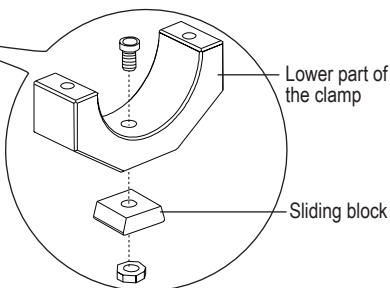

Power Connection to Cigarette Lighter Socket (Option 1)

The sound bar can be powered by direct connection to your vehicle cigarette lighter socket as an optional power supply.





See “Before You Start” section for installation precautions.

This sound bar is operated with 12 V DC vehicle voltage. Never connect the sound bar to any other voltage supply (e.g. 24 V DC power supply in trucks or buses).

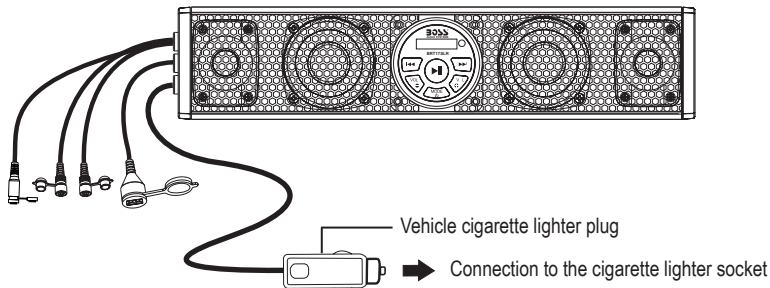
1. Simply insert the cigarette lighter plug of the sound bar into your vehicle cigarette lighter socket. When the power supply is connected, the power LED indicator lights up.



Turn on or off

- Press and hold  on the sound bar (or on the remote control) to turn on or off the sound bar.
- Press briefly  on the remote control to turn on or off the LED lights.

Power Connection to Vehicle Battery (Option 2)

The sound bar can be also powered by connection to your vehicle battery as an optional power supply.



See "Before You Start" section for installation precautions.

To avoid short circuits and any resulting damage to the sound bar, the negative terminal of the car battery must be disconnected first.

We recommend a fuse and fuse holder (both not included) with minimum rating of 15 A are in line with the positive terminal of the vehicle battery.

The ground cable length should not exceed 18" (46 cm).

1. Connect the black wire of the cigarette lighter plug adapter to the chassis ground point.
2. Connect the red wire of the cigarette lighter plug adapter to the positive terminal of the vehicle battery using 12 - 14 gauge wire (not included).

We recommend installing a relay and 15 A fuse and fuse holder in line with the vehicle battery (Relay, fuse and fuse holder are not included). See the illustration below.

3. Connect the cigarette lighter plug of the sound bar into the cigarette lighter plug adapter.

When the power supply is connected, the power LED indicator lights up.

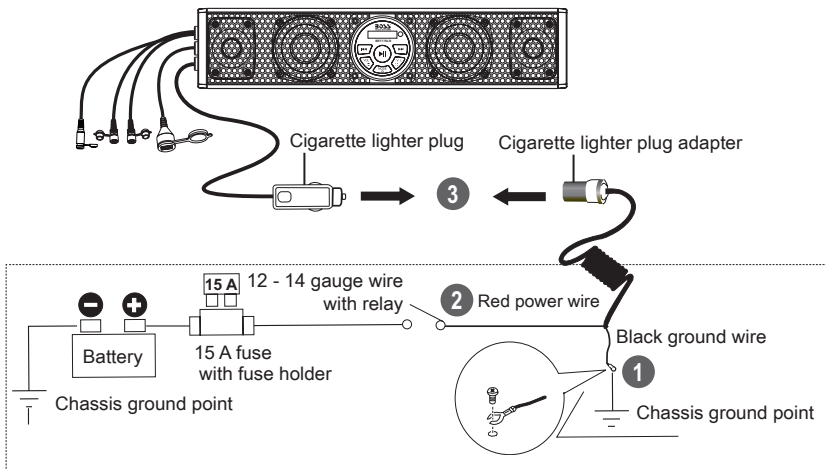

Before you can stream music from your mobile device (iOS device or Android device) to the sound bar through Bluetooth, pair the sound bar with your mobile device.

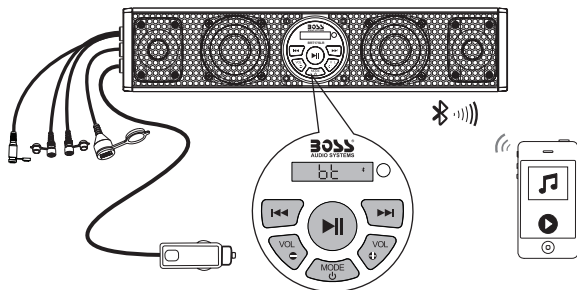

1. The sound bar automatically switches to Bluetooth mode when turned on. "bt" appears and flashes to indicate that the sound bar enters pairing mode.
If Bluetooth mode is not selected, press briefly **MODE**  to select Bluetooth mode.
2. On your mobile device, enable Bluetooth function and select the device name ("Boss Audio BRT17SLR") to pair the sound bar with the mobile device. If prompted for password, enter "0000".
If no Bluetooth device is paired within two minutes, the sound bar will automatically exit pairing mode. In this case, you need to repeat the steps above to re-enter the pairing mode.
3. When successfully paired/connected, "bt" on the display stops flashing and lights up. Play audio on your mobile device, and audio will be streamed to the sound bar.
After pairing, the sound bar will be automatically connected to your mobile device each time the two are turned on. To connect a second mobile device, disconnect the current Bluetooth connection by holding down **▶||** for two seconds then repeat the steps above for pairing.

Playback control

- To pause or resume play, press **▶||**.
- To select the previous or next track, press **◀◀** or **▶▶**.
- To adjust volume, press **VOL +/-**.

➔ To maximize audio performance, set the volume of the device to its 75% minimum. Ideally, on the highest volume setting you can get without distortion.

To avoid battery exhaustion, make sure to run the vehicle engine when operating the sound bar. Operational range can be reduced by any obstacle between the sound bar and the device.

If the connected device is out of the effective range from the sound bar, the device will be automatically disconnected. The device will be automatically re-connected if it is within the effective range again.

You can listen to an external audio device (e.g. MP3 player or a mobile phone) through the sound bar.

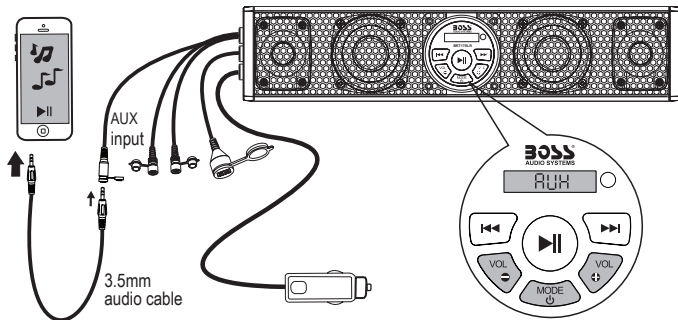

1. Using an audio cable with 3.5mm plug (not included), connect the AUX input (3.5 mm) on the sound bar to the headphone jack on your audio device.
2. The sound bar automatically switches to AUX mode when AUX connection is made. "AUX" is displayed. If AUX mode is not selected, press briefly **MODE**  to select AUX mode.
3. Select and play audio files on your audio device. Audio from the connected device will be played on the sound bar.

➔ To maximize audio performance, set the volume of the device to its 75% minimum. Ideally, on the highest volume setting you can get without distortion.

Operating the sound bar consumes the vehicle battery. To avoid battery exhaustion, make sure to run the vehicle engine when operating the sound bar.

Playback control

- To adjust volume, press **VOL +/-** on the sound bar or use the controls on connected device.
- To control playback, use the controls on the connected device.

You can enjoy audio stored on a USB storage device through the sound bar.

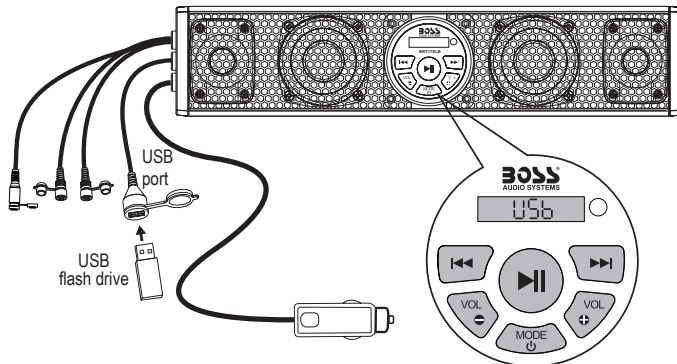

1. Connect a USB flash to the USB port on the sound bar.
2. The sound bar automatically switches to USB mode when USB connection is made. "USB" is displayed briefly.

If USB mode is not selected, press briefly **MODE**  to select USB mode.

Music plays automatically.

- ➔ MP3 and WMA files are playable. The USB port can provide 1A current for mobile device charging. Operating the sound bar consumes the vehicle battery. To avoid battery exhaustion, be sure to run the vehicle engine when operating the sound bar.

Playback control

- To pause or resume play, press **▶||**.
- To select the previous or next track, press **◀◀** or **▶▶**.
- To adjust volume, press **VOL +/-**.

You can output audio from the sound bar to an external amplifier or powered speakers through RCA output.

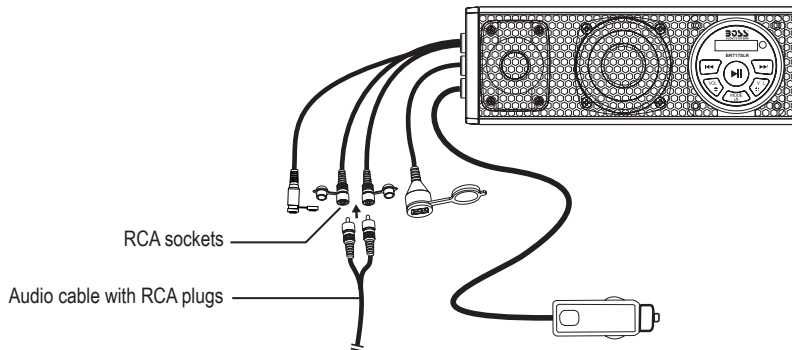

Fuse Replacement

If the power LED indicator on the vehicle cigarette lighter plug does not light up, this indicates the fuse inside the cigarette lighter plug is blown. Replace the blown fuse with a 10A AGC fuse only.

1. Turn counterclockwise the front end assembly of the cigarette lighter plug to open to access the fuse.
Replace with a new fuse (not included). Then replace the front end assembly of the cigarette lighter plug.

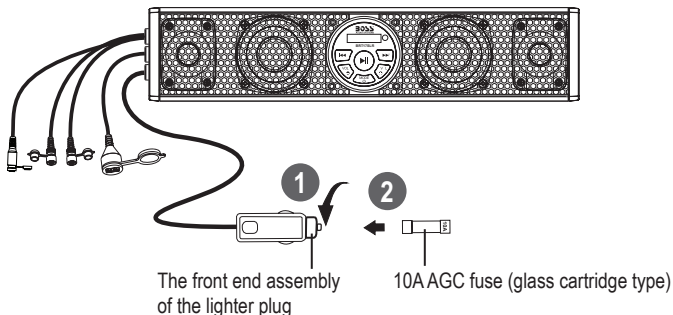

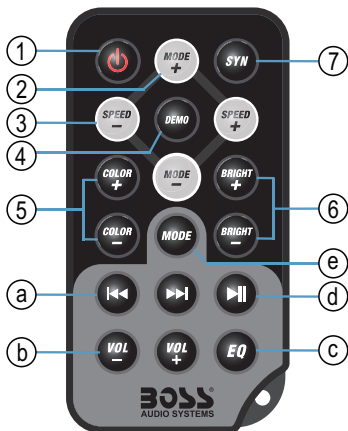

The sound bar comes with a remote control. You can use the remote control to control both music playback and the LED lights which are integrated with the sound bar.



Light control buttons

- 1  Press and hold to turn the sound bar on or off.
Press briefly to turn lights on or off.
- 2 **MODE +/-** Select an illumination mode.
- 3 **SPEED +/-** Select an illumination speed.
- 4 **DEMO** Activate lights cycling through red, green and blue color.
- 5 **COLOR +/-** Select an illumination color mode.
- 6 **BRIGHT +/-** Change illumination intensity.
- 7 **SYN** Activate or deactivate lights flashing to music.

Playback control buttons

- a  Select the previous or next track.
- b **VOL +/-** Increase or decrease volume.
- c **EQ** Select a preset sound mode.
- d  Start, pause or resume music play.
- e **MODE** Select a mode (Bluetooth, AUX and USB).

If you have problems using this product, check the following points before you request service. If you still have a problem, contact our technical support.

Problem	Solution
No power	The fuse inside the vehicle cigarette lighter plug is blown. Replace the fuse.
	The ACC switch of the vehicle is not on. Turn the ACC switch on.
No sound	Press MODE to select the correct audio input.
	Volume of the connected device is low or muted. Increase volume on the connected device.
	Playback on the connected device pauses or stops. Resume playback on the connected device.
Cannot connect through Bluetooth	The device is not paired with the sound bar. Pair the two (see "Bluetooth Play" section).
	Bluetooth on the device is disabled. Refer to the device's user manual on how to enable Bluetooth.
	Make sure the device is within range.
	The sound bar is already connected with another Bluetooth device. Disconnect the current Bluetooth connection.
Audio quality from Bluetooth connection is poor.	Move the device closer to the sound bar or remove obstacles or sources of interference that are affecting Bluetooth reception.
No response	Power glitch or interference. Disconnect power for ten seconds then reconnect power.

Care of the Environment

Do not throw away the product with the normal household waste at the end of its life, but hand it in at an official collection point for recycling. By doing this, you help to preserve the environment.

Bluetooth

Bluetooth version.....	5.0 / EDR
Bluetooth profiles.....	A2DP, AVRCP
Bluetooth frequency.....	2402 - 2480 MHz
Transmission power.....	<4 dBm
Transmission distance.....	up to 33 ft / 10 m (line of sight)

Speakers

High power speaker size.....	(2) 3" / 76.2 mm
Tweeter size.....	(2) 1" PEI dome

Amplifier

Amplifier class.....	Class A/B
Input impedance.....	10 k Ω
Frequency response.....	45 Hz - 22 kHz

Connectivity

USB.....	USB-A, MP3/WMA playable; mobile device charging (1A)
AUX.....	3.5 mm jack for audio input
RCA.....	RCA sockets for audio output

General

Input voltage.....	12 V DC (allowable 10 - 16 V DC)
Current draw.....	max. 4 A
Fuse.....	10 A AGC type
Clamp size range (O.D.).....	1.75" - 2"
Weight.....	5.07 lbs / 2.3 kg

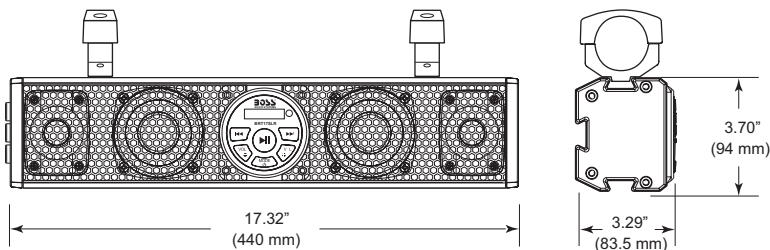
Dimension drawing

BOSS[®]
AUDIO SYSTEMS



BOSS Audio Systems
3451 Lunar Court • Oxnard, CA 93030
www.bosssaudio.com
805-751-4853 Customer Service
Tech Support: www.bosssaudio.com/support



0721

The Bluetooth[®] word mark and logos are registered trademarks owned by Bluetooth SIG, Inc. and any use of such marks by BOSS Audio Systems is under license. Other trademarks and trade names are those of their respective owners.