

**Metris**

**Single-Hole Faucet 260 with Pop-Up Drain, 1.2 GPM**

Finishes : **chrome** Part no. : **31082001**



**Description**

**Features**

- Aerated spray
- Flow: 1.2 GPM (4.5 L/Min)
- Ceramic cartridge
- Includes pop-up drain

**Item details**

List Price \$ 532.00

**Technology**



**Compliance**



**Product image**



**Scale drawing**

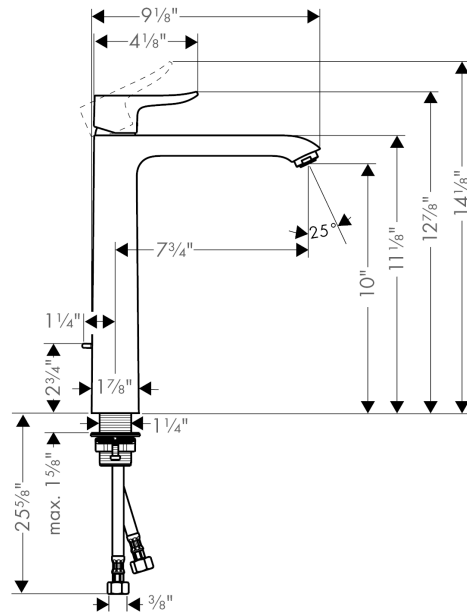

**Metris**  
**Single-Hole Faucet 260 with Pop-Up Drain, 1.2 GPM**  
 Finishes : **chrome** Part no. : **31082001**



Exploded drawing

Year of production: >07/16

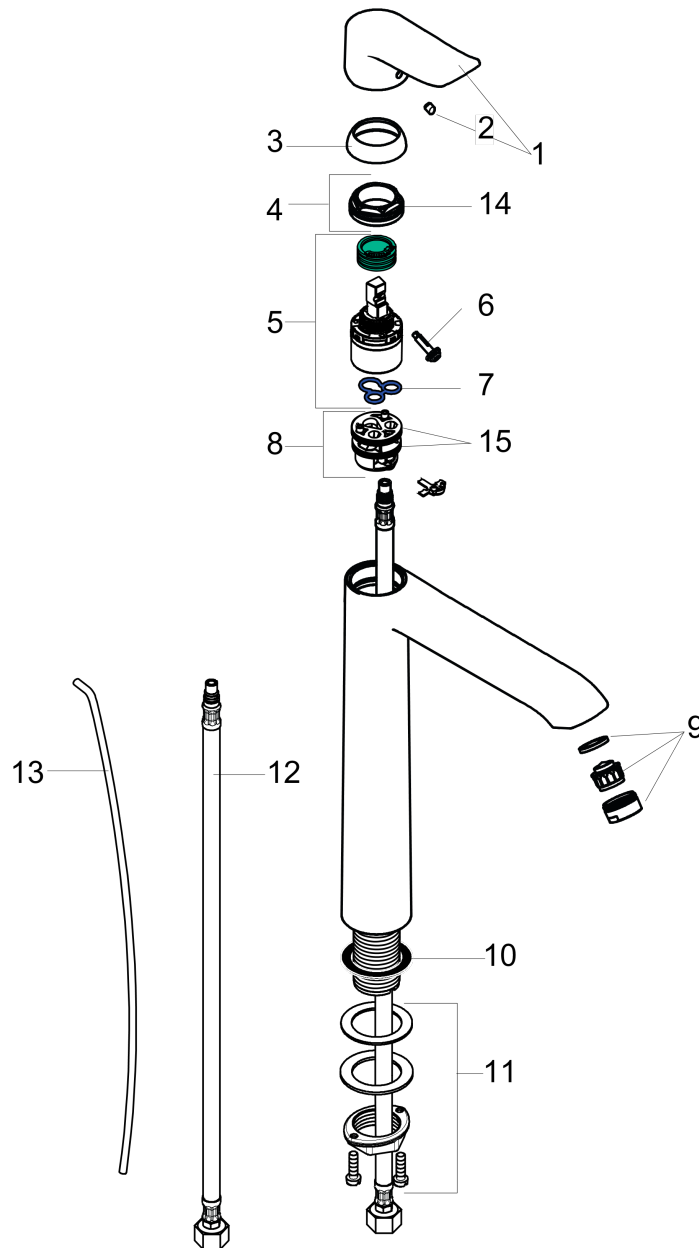

**Metris**

**Single-Hole Faucet 260 with Pop-Up Drain, 1.2 GPM**

Finishes : **chrome** Part no. : **31082001**



**Spare parts list**

Year of production: >07/16

Pos.	Description	Part no.	Price	PU
1	handle	95519000	-	1
2	screw cover	96338000	-	1
3	flange	97406000	-	1
4	nut	97209000	-	1
5	cartridge, assy	95646001	-	1
6	locking screw for handle	95140000	-	1
7	seal	95008000	-	1
8	adapter for cartridge	98750000	-	1
9	aerator M24x1 (4,5 l/min)	92877000	-	1
10	flat seal	98749000	-	1
11	fixing set (Ø 32)	13961000	-	1
12	connection hose 35½" M8x0,75 3/8"	96316001	-	1
13	pull rod	96657000	-	1
14	O-Ring 32x2	98193000	-	1
15	O-Ring 30x2	98186000	-	1
a	pop up waste	88509000	-	1
b	lever arm 340mm (ball-Ø12mm)	96324000	-	1