

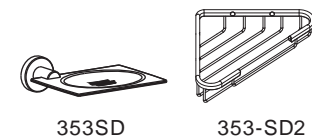

Accessory Installation Instructions

- 353TB-18 Towel bar
- 353TB-24 Towel bar
- 353DTB-18 Towel bar
- 353DTB-24 Towel bar
- 353TS-22 Towel shelf
- 353TR Towel ring
- 353RH Robe hook
- 353DRH Double robe hook
- 353TH Toothbrush holder
- 353TP Toilet Paper holder
- 353TPC Toilet Paper holder
- 353SD Soap dish
- 353-SD2 Soap basket

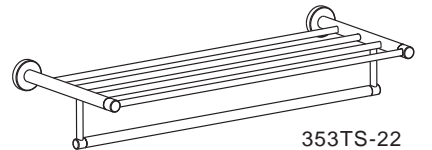
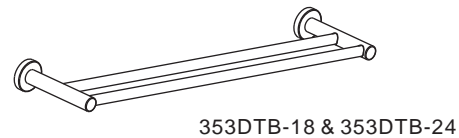
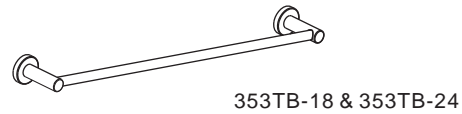

Feature Highlights

- Metal construction
- Standard finish is polished chrome

Finish Options

- Append appropriate-suffix to model number.
- STN Satin nickel finish

Warranty

- Limited Lifetime - to the original end purchaser in residential/consumer installations
- 5 years - for commercial installations

For California Residents

WARNING: This product contains chemicals known to the State of California to cause cancer, birth defects, or other reproductive harm.

MEASUREMENT BEFORE INSTALLATION

MODEL NO.	LENGTH X=inch
353TB-18	18.03
353TB-24	23.62
353DTB-18	18.03
353DTB-24	23.62
353TS-22	22.05

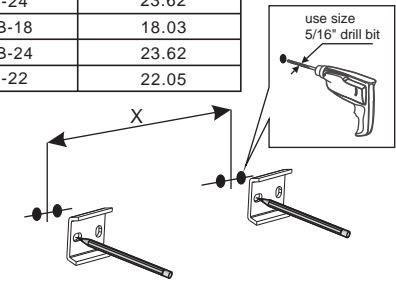

1 Measure and mark holes as listed in the above table. Drill screw mounting holes using a size 5/16" drill bit. **-IMPORTANT:** Ensure that the holes you have drilled for installation are level.

REPLACEMENT PARTS

MODEL NO.	DESCRIPTION
RA-017	Mounting Hardware Kit

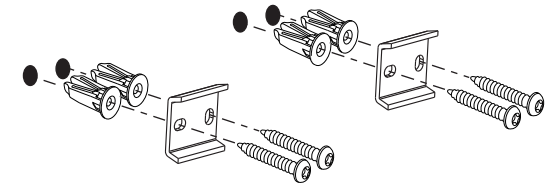

RECOMMENDED TOOLS AND MATERIALS

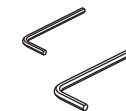

2 Affix your mounting hardware to the wall using your mounting screws. For plaster walls 1/2" thick or less, insert toggle tool into toggle anchor to secure behind wall prior to installing accessory trim.

353-SD2 Only:

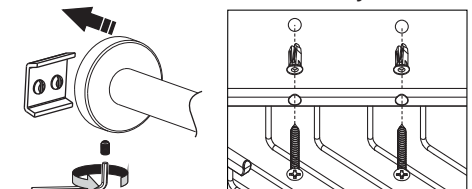

3 After securing your mounting hardware to the wall, place the mounting end of your accessory onto the mounting hardware as is shown in the picture above. Affix your accessory to the mounting hardware using the Allen wrench that shipped with the product.

■ All specifications subject to change without prior notice.

ACCESSORY INSTALLATION INSTRUCTIONS

DIMENSIONS

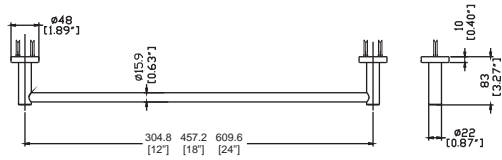

353TB-18 & 353TB-24

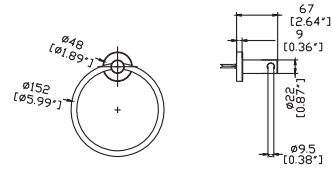

353TR

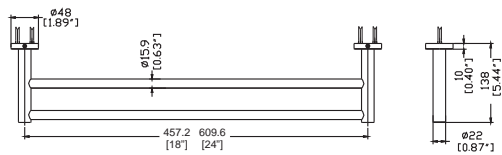

353DTB-18 & 353DTB-24

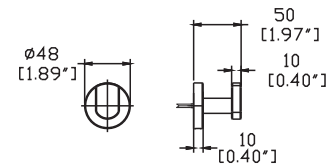

353RH

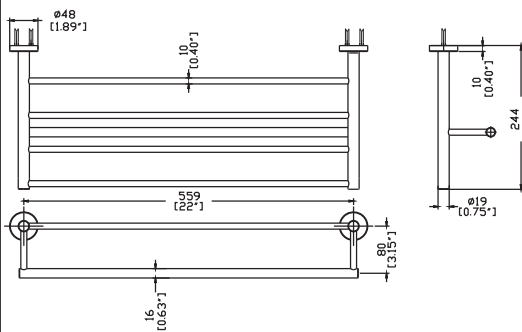

353TS-22

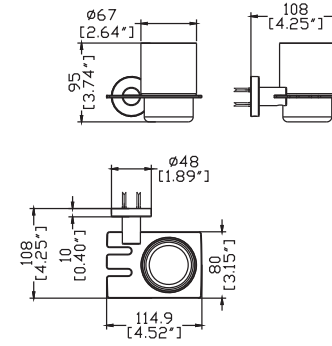

353TH

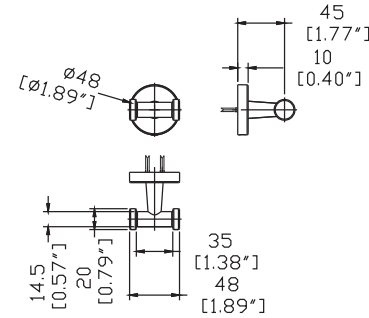

353DRH

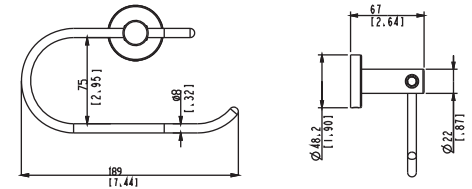

353TPC

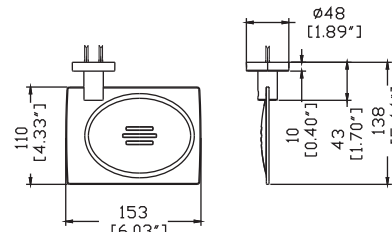

353SD

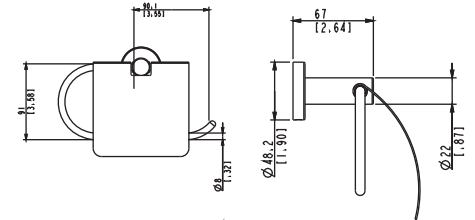

353TPC

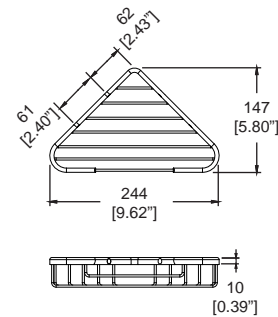

353-SD2

IMPORTANT CLEANING INSTRUCTIONS

- To ensure that your Symmons product will continue to look as beautiful as the day it was installed, please follow these simple cleaning instructions.
 - To clean the finish on your Symmons product, rinse with clean water, wipe with a soft damp cloth and blot dry with a soft cotton cloth or towel.
 - If heavy cleaning is required start by cleaning as described in Step 1. Use a mild liquid soap or liquid glass cleaner to remove any remaining surface buildup. Rinse product with clean water to remove any remaining cleaning solution and blot dry with a soft cotton cloth or towel.
- Do not use cleaning products containing abrasives, acids, alcohol, bleach or foaming compounds. If any unintentional splashing or overspray of these types of cleaning products comes in contact with your Symmons product, immediately rinse it with clean water and blot dry with a clean soft cotton cloth or towel.

