

SIDES	BOTTOM
5 Pcs 6-32x5/16 screws Pack In Poly-bag Separately	
4 Pcs 6-32 Nut Pack In Poly-bag Separately	
Material: Steel-0.0625"-G60 Galvanized	

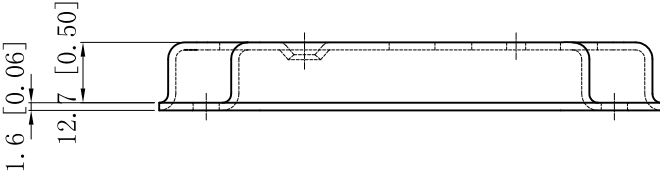

CUTAWAY VIEW A-A

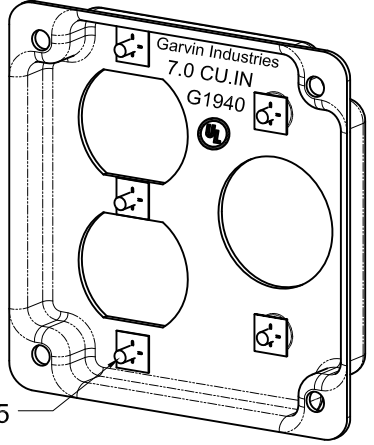
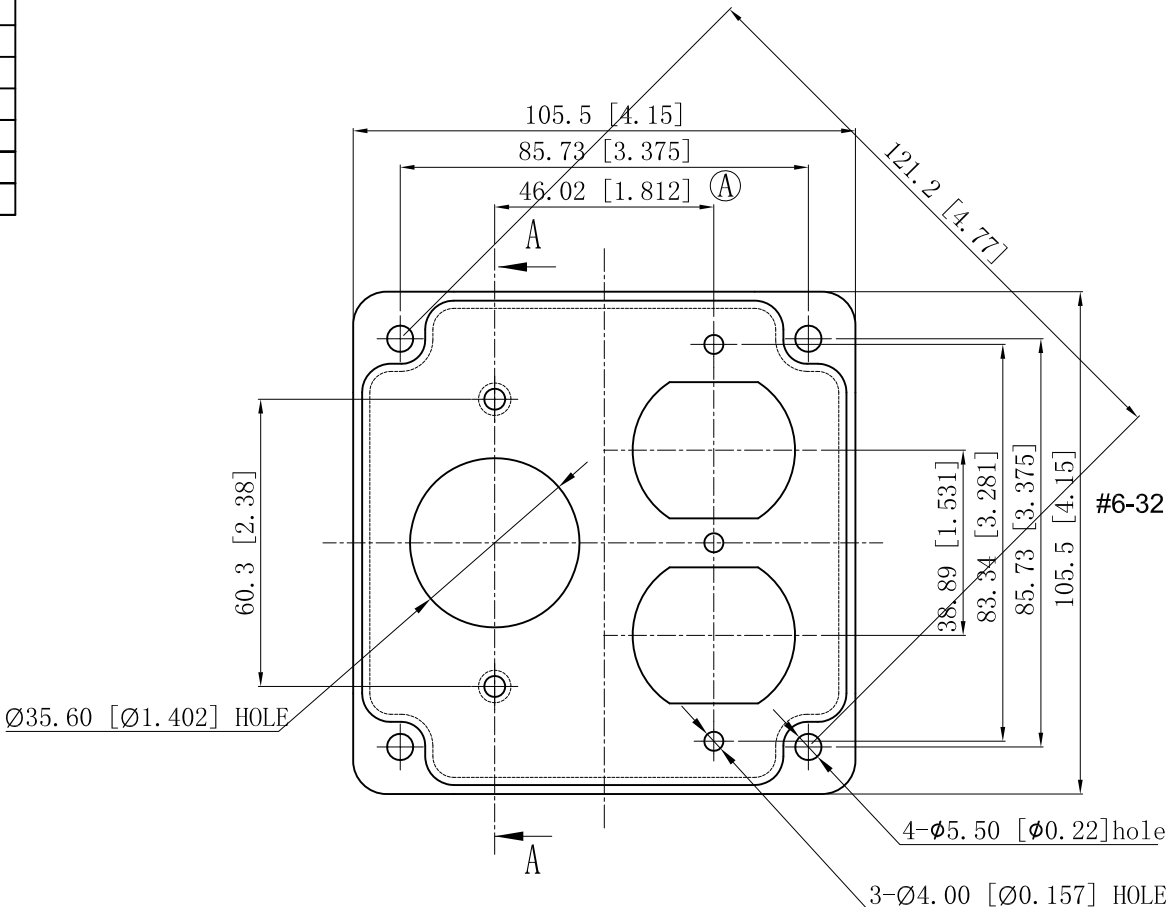

This data sheet is for reference only .GARVIN INDUSTRIES reserves the right to make changes to the design without prior notice.

DESCRIPTION
TRADE REFERENCE TERMS

STANDARD PACKING	GARVIN INDUSTRIES		
50 PCS	TITLE 4" SQUARE INDUSTRIAL "GARVIN" COVERS		
	SIZE A4	DWG NO. G1940	REV E
	DATA SHEET		