



Extended Warranty
Sign Up

E-1

Welcome to a
world of imagination,
fun and learning.

TD-13125A

**Fantasy Fields
Hot Air Balloon Set
Of 3 Peg Hooks**

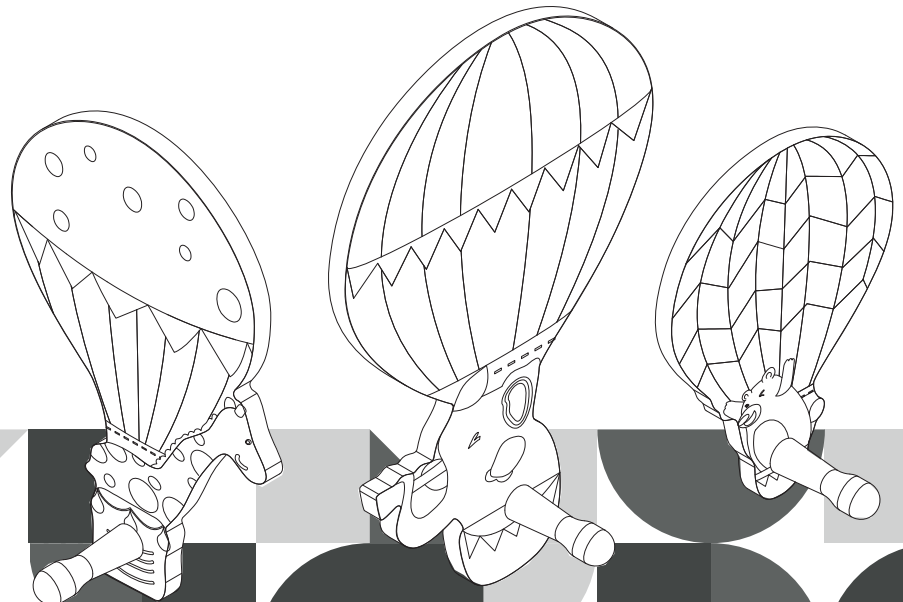

⚠ WARNING

CHOKING HAZARD - Small Parts
Not for children under 3 years
The product is to be assembled
by an adult.

Warranty

All components are warranted by the manufacturer for a period of 30 days after the date of purchase by the original owner against defects in materials & workmanship under normal use. If it is appropriate to replace your product due to specific defects, the manufacturer will replace the purchase with the same product or a comparable product.

For specific instructions on how to obtain warranty service for your product, please contact Customer Service using the contact information provided.

Global Customer Service

USA



✉ support@teamson.com

+1(800)935-3959

Mon - Fri 10:00am ~ 2:00pm EST

EU/UK



✉ support@teamson.co.uk

+44(0)1952-916-050

Mon - Thu 9:00am ~ 5:00pm GMT

Friday 9:00am ~ 4:00pm GMT

ASIA

深圳办公室:

✉ sales_ec@teamson.com

+86(0755)8885-3558.分机号331

Mon - Sat 9:00am ~ 5:00pm GMT+8

台北办公室:

✉ sales_ec@teamson.com

+886(2)2556-6268

Mon - Fri 9:00am ~ 5:00pm GMT+8



ENGLISH WARNING! Not suitable for children under 3 years, as there is a choking hazard from swallowable small parts. Assembly should be carried out by an adult. Prior to assembly this package contains sharp edges and sharp points. Keep away from children until assembled. Please remove all packaging attachments before giving this item to your child. Please keep this information for possible future correspondence.

ČESKY UPOZORNĚNÍ! Výrobek není vhodný pro děti do 3 let. Obsahuje drobné části, hrozí nebezpečí udušení. Montáž musí provádět dospělý. Design a barvy výrobků mohou být změněny bez předchozího upozornění. Před prvním použitím odstraňte všechny obaly z dosahu dětí. Tyto informace uschovejte pro případné budoucí použití.

CROATIA UPOZORENJE! Igračka nije prikladna za djecu mlađu od tri godine zbog malih dijelova gušenje opasnost. Skupština mora biti izvedena od strane odrasle osobe. Varijacije u boji i dizajnu, mi se pridržavamo. Uklonite sve ambalaze prije prve uporabe. Sačuvajte ove informacije za bilo koji naknadno dopisivanje.

DUTCH WAARSCHUWING! Niet geschikt voor kinderen beneden 3 jaar omdat er gevaar voor verstikking door inslikbare kleine voorwerpen bestaat. De montage van dit speelgoed moet door een volwassene worden uitgevoerd. Kleuren en versieringen kunnen afwijken. Verwijder alle verpakkingselementen voordat u dit speelgoed aan uw kind geeft. Bewaar deze verpakking voor een eventuele latere correspondentie.

FRENCH ATTENTION! Ce produit est inadapté aux enfants de moins de 3 ans, car il existe le risque d'étouffement causé par les petites pièces qui peuvent s'avaler. Le montage doit être effectué par un adulte. Nous nous réservons le droit d'apporter des modifications aux couleurs et à la conception. Retirez l'emballage et les attaches plastiques avant de donner cet article à votre enfant. Nous vous prions de conserver cette information pour une éventuelle utilisation ultérieure.

GERMAN ACHTUNG! Nicht geeignet für Kinder unter 3 Jahren, da Erstickungsgefahr durch verschluckbare Kleinteile besteht. Der Zusammenbau muss von einem Erwachsenen durchgeführt werden. Abweichungen in Farbe und Gestaltung behalten wir uns vor. Bitte entfernen Sie alle Verpackungsteile vor dem erstmaligen Gebrauch. Bitte bewahren Sie diese Information für evtl. spätere Korrespondenz auf.

HUNGARY FIGYELMEZTETÉS! Nem alkalmas 3 év alatti gyermekek, mert a kis alkatrészek fulladást okozhatnak. A szerkezetet úgy kell elvégezni egy felnőtt. Szín és design fenntartva. Kérjük, távolítsa el a csomagolást az első használat előtt. Kérjük, őrizze meg ezt az információt bármilyen későbbi vonatkozó levelezést.

ITALIAN AVVERTENZA! Non adatto a bambini al di sotto dei 3 anni, visto che vi è rischio di asfissamento causato dall'ingerimento di componenti piccoli. Il montaggio di questo prodotto deve essere fatto sotto di un adulto. I colori e le decorazioni possono variare. Per favore conservare la confezione nel caso ci sia bisogno di spedire indietro qualcosa.

POLSKI OSTRZEŻENIE! Produkt nie nadaje się dla dzieci poniżej 3-go roku życia. Ze względu na małe części istnieje ryzyko zadławienia, połknięcia, itd. Montaż wózka powinien odbywać się pod nadzorem osoby dorosłej. Przed pierwszym użyciem proszę usunąć wszystkie elementy opakowania. Kolory i wzory mogą się różnić. Należy zachować opakowanie w przypadku konieczności wymiany.

PORTUGAL AVISOS! Guarde esta informação para futura referência. Não apropriado para crianças com menos de 3 anos de idade devido à existência de peças pequenas e bordas/pontas afiadas. Este brinquedo deve ser montado por um adulto. As cores e o conteúdo podem ser algo diferentes do mostrado na caixa. Retire todo elemento de embalagem antes de entregar o produto à criança.

SLOVENIJA OPOZORILO! Ni primerno za otroke mlajše od treh let. Nevarnost zadušitve. Majhni deli. Sestav mora opraviti odrasla oseba. Razlike v barvo in obliko, si pridržujemo pravico do. Prosimo, odstranite vse pakirni material pred prvo uporabo. Prosimo, da shranite te informacije za vsak nadaljnji korespondenci.

SLOVENSKY UPOZORNENIE! Výrobok nie je vhodný pre deti do 3 rokov. Obsahuje drobné časti, hrozí nebezpečenstvo udusenía. Montáž musí vykonávať dospelý. Design a farby výrobkov môžu byť zmenené bez predchádzajúceho upozornenia. Pred prvým použitím odstráňte všetky obaly z dosahu detí. Tieto informácie uschovejte pre prípadné budúce použitie.

SPAIN ADVERTENCIA! Guarde esta información para futura referencia. No apto para niños menores de 3 años por contener piezas pequeñas, contiene bordes/puntas afiladas. Este juguete debe ser montado por un adulto. Los colores y el contenido pueden ser algo diferentes de lo mostrado en la caja. Retire todos los elementos de embalaje antes de dar el artículo a su hijo.

SVENSKA VARNING! Inte lämplig för barn under 3 år på grund av små delar kvävningsrisk. Monteringen måste utföras av en vuxen. Färg och design är reserverade. Ta bort allt förpackningsmaterial före första användningen. Vänligen behålla denna information för eventuell senare korrespondens på.

繁體 警告! 需由成年人完成組裝。本產品不適於3歲以下兒童使用。本包裝包含細小零件, 完成組裝前, 請慎防兒童吞食小零件, 避免窒息危險, 且可能有鋒利邊緣及尖角, 所以組裝完成前應置於兒童不能觸及之處, 並遠離火源。

簡體 警告! 需要成年人完成組裝。不适合三歲以下的兒童使用。完成組裝前, 本包裝包含細小零件, 可能引發窒息; 以及包含鋒利邊緣和尖角, 所以完成組裝前, 請確保其遠離兒童。



CE UK CA 02



Scan for assembly instructions.

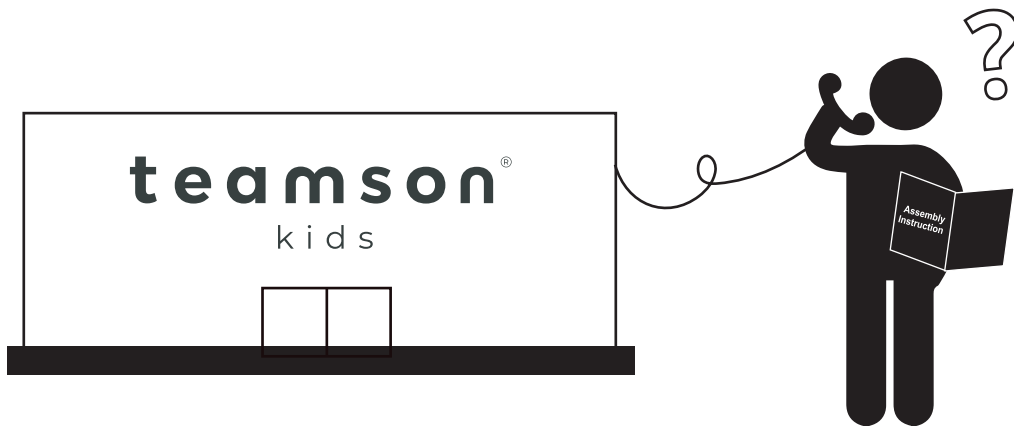
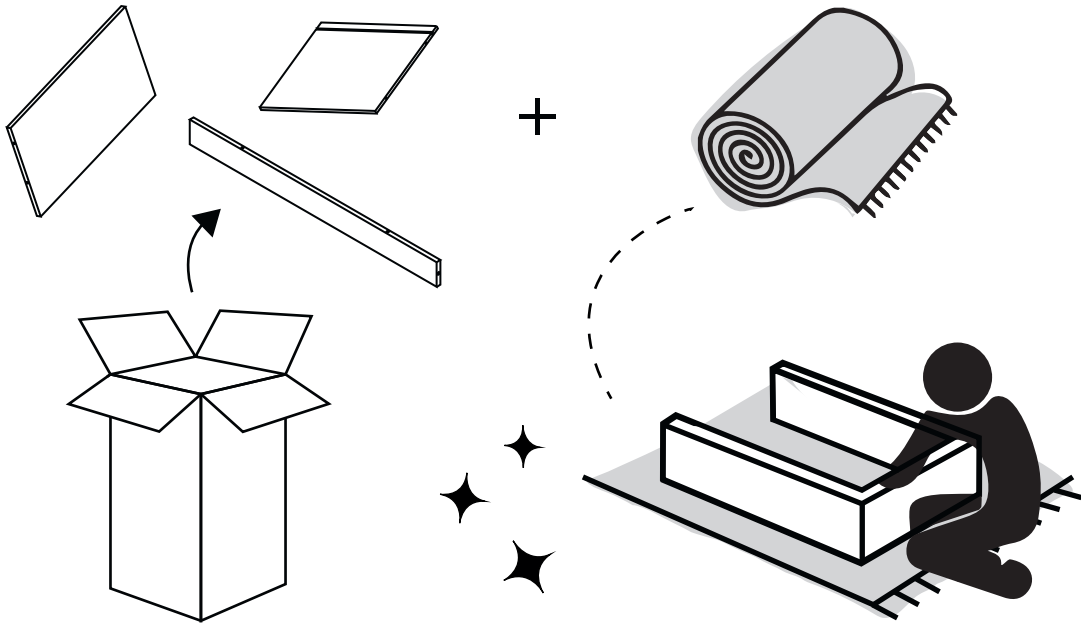
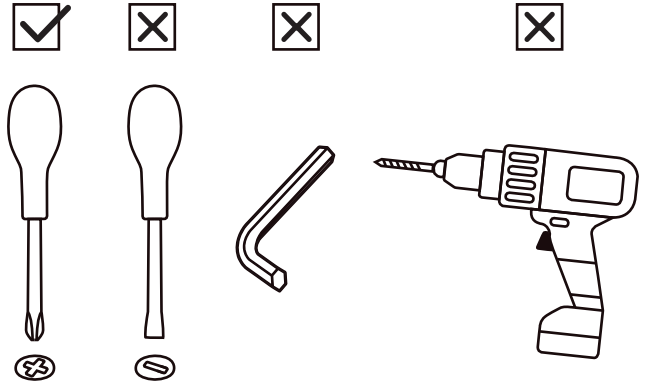

** Got questions? Please have your product code (on the first page of this instruction, e.g. TD-12345A) and the order number ready, give us a call or email us through our customer care support! We are always ready to assist you!

Exploded Drawing

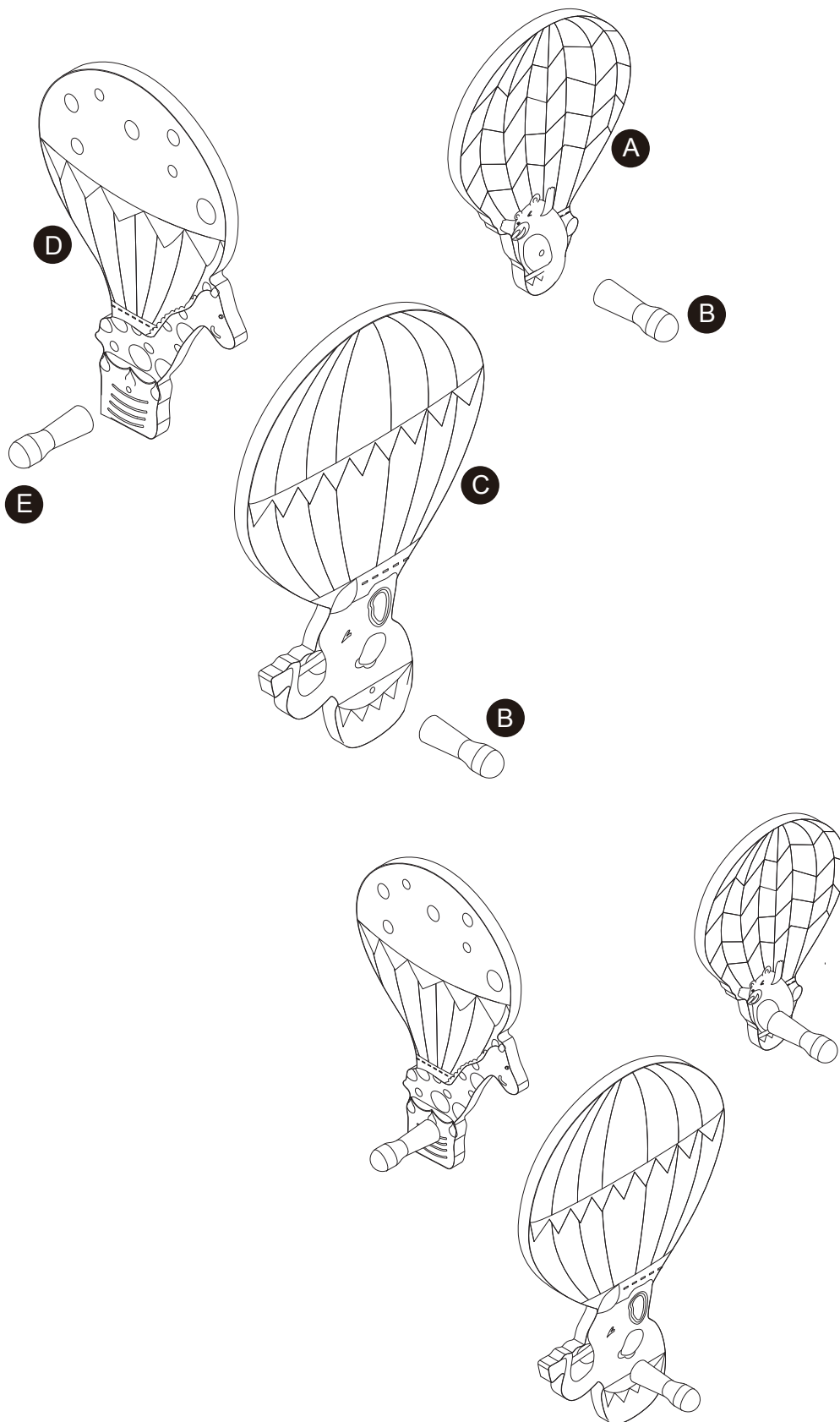

Scan for assembly instructions.

Product Parts

A



B

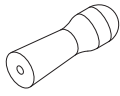

2 pcs

C



D



E

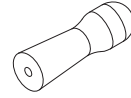

Hardware

1

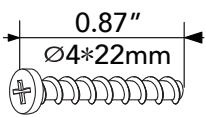

3 pcs



Scan for assembly instructions.

⚠ WARNING

CHOKING HAZARD - Small Parts
Not for children under 3 years
The product is to be assembled
by an adult.

Step 1

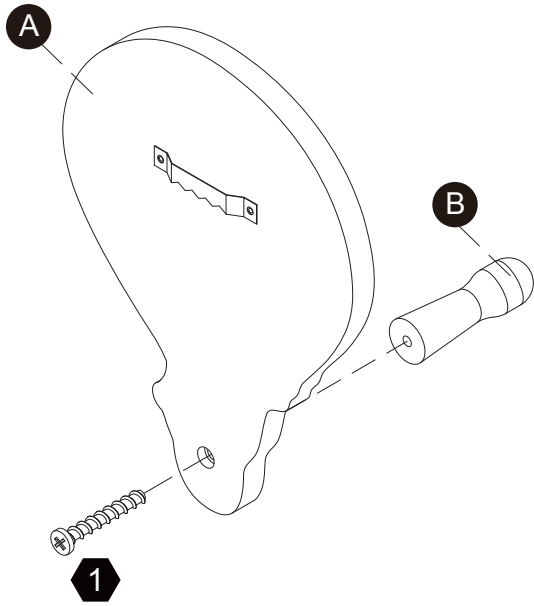
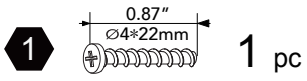

Step 2

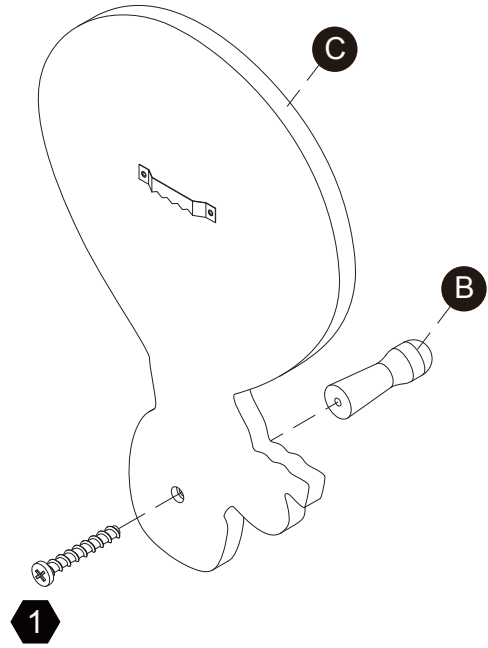
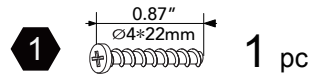

Step 3

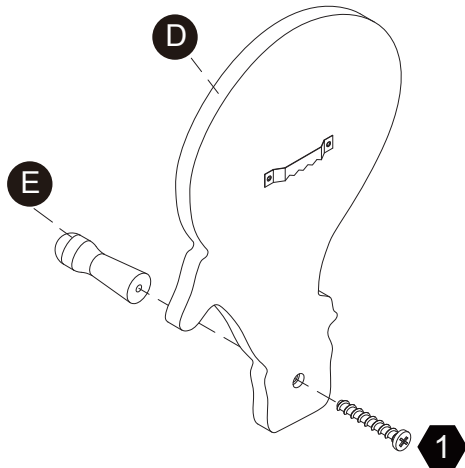
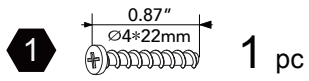

Step 4

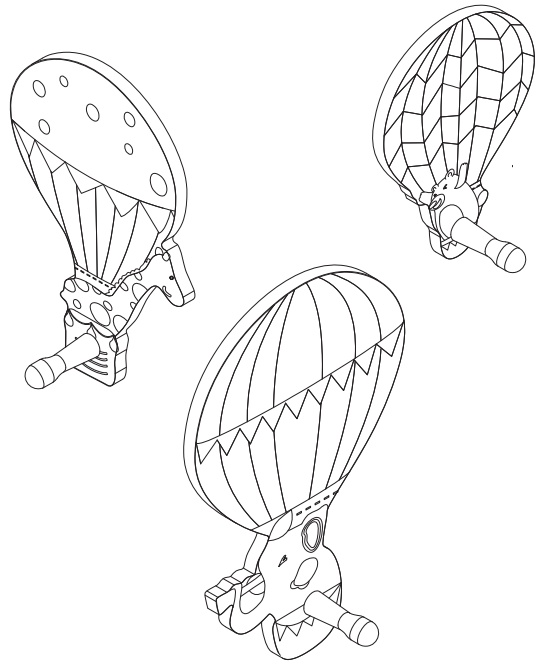

Scan for assembly instructions.