

# JUNO®

# 6" SHALLOW UNIVERSAL IC HOUSING

## INCANDESCENT LAMPS IC21 SERIES

Project: \_\_\_\_\_

Fixture Type: \_\_\_\_\_

Location: \_\_\_\_\_

Contact/Phone: \_\_\_\_\_

### PRODUCT DESCRIPTION

IC Housing Air-Loc® Ready • Energy efficient, sealed housing  
• Can be completely covered with insulation • When used with Air-Loc Gasket accessory or pre-installed gasket on mounting frame, stops infiltration and exfiltration of air, reducing heating and cooling costs • Trims shown with Air-Loc symbol  do not require a gasket.

### PRODUCT SPECIFICATIONS

**Lamp** Lamp ratings based on trim selected – see page 2.

**Socket** Medium base porcelain with nickel-plated copper screw shell  
• Floating socket with spring attaches to trim for installation.

**Trims** Trim selection shown on page 2.

**Labels** UL listed for through-branch wiring, damp locations and IP  
• Product thermally protected against improper use of lamps  
• Union made • UL Listed/CSA certified • Trim No. 241 is wet location approved for covered ceiling applications.

**Testing** All reports are based on published industry procedures; field performance may differ from laboratory performance.

Specifications subject to change without notice.

### INSTALLATION

**Real Nail® 3 Bar Hangers** Telescoping, Patented (US Patent D552,969) Real Nail 3 system permits quick placement of housing anywhere within 24" O.C. joists or suspended ceilings • Integral T-bar notch and clip secures housing in suspended ceiling grid – no accessory clips required • 24" expansion stop allows quick placement of fixture in standard grid spacing • Bars scored in two locations for fast, clean breaking, allowing housing installation in tight applications • Bars captive to mounting frame • Edge-mounted for extra strength • Captive bugle-headed ring shank nail for quick one-step installation and easy removal with claw hammer for fixture relocation • Quick-Loc slot (location identified on the mounting frame) and oversized locking set screw lock fixture in position • Bar hanger foot contoured to align to bottom of construction joist • Alternate mounting holes included.

**Junction Box** Pre-wired junction box provided with (5) 1/2" and (1) 3/4" knockouts, (4) Non-metallic sheathed cable connectors and ground wire, U.L. listed/CSA certified for through branch wiring, maximum 8 No. 12 AWG 90° C branch circuit conductors (4 in, 4 out) • Junction box provided with removable access plates  
• Knockouts equipped with pryout slots.

**Mounting Frame** 22-gauge die-formed galvanized steel mounting frame • Rough-in section (junction box, mounting frame, housing and bar hangers) fully assembled for ease of installation • Sight lines embossed on mounting frame to allow for easy viewing when aligning fixtures • Pre-installed Air-Loc gasket for **G options**.

**Housing** IC housing, .032" aluminum sealed for Air-Loc Compliance • Housing is vertically adjustable to accommodate up to a 1" ceiling thickness.

### DIMENSIONS

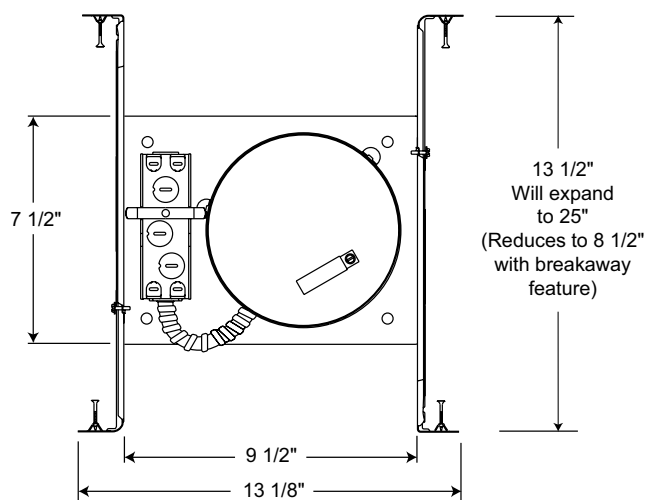
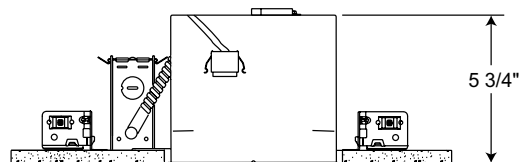

6 7/8" CEILING CUTOUT

### ACCESSORIES

Catalog Number	Description
ALG6	Air-Loc Gasket

To order, specify catalog number.

### PRODUCT CODES

Catalog Number	Input Voltage	Lamp Rating
<b>IC21</b>	120V	A19/R20/PAR20/BR30/PAR30/PAR30L (See page 2 for max. trim rating)
<b>IC21 G</b>	120V	A19/R20/PAR20/BR30/PAR30/PAR30L (See page 2 for max. trim rating)
<b>IC21 W G</b>	120V	A19/R20/PAR20/BR30/PAR30/PAR30L (See page 2 for max. trim rating)









Housing and trim can be ordered together or separate, but will always ship separately.

# 6" SHALLOW UNIVERSAL IC HOUSING

## INCANDESCENT LAMPS

### IC21 SERIES

#### TRIMS/LAMPS

	Catalog Number	Description	Max. Lamp Rating
 ** 	<b>2445 BWH</b> <b>2445 WWH</b>	Shallow Black Baffle, White Trim Ring Shallow White Baffle, White Trim Ring	50W PAR30
 ** 	<b>2475 CWH</b> <b>2475 GWH</b> <b>2475 BWH</b> <b>2475 HZWH</b> <b>2475 WHZWH</b>	Shallow Clear Alzak® Cone, White Trim Ring Shallow Gold Alzak® Cone, White Trim Ring Shallow Black Alzak® Cone, White Trim Ring Shallow Haze Cone, White Trim Ring Shallow Wheat Haze Cone, White Trim Ring	75W PAR30, 65W BR30
	<b>250 WH</b> <b>250 SC</b> <b>250 BRZ</b>	Open Frame, White Open Frame, Satin Chrome Open Frame, Bronze	65W BR30
	<b>229 WH</b> <b>229 SC</b> <b>229 BRZ</b> <b>229 BL</b>	Regressed Eyeball, White Regressed Eyeball, Satin Chrome Regressed Eyeball, Bronze Regressed Eyeball, Black	75W PAR30L, 65W BR30
	<b>249 BWH</b> <b>249 WWH</b>	Regressed Eyeball, Black Baffle, White Trim Ring Regressed Eyeball, White Baffle, White Trim Ring	75W PAR30L, 65W BR30
 	<b>241 WH ♦</b> <b>241 PW ♦</b>	Drop Opal w/Reflector, White Drop Opal w/Reflector, Plastic White	40W A19

Trim Size: 7 $\frac{5}{8}$ " O.D. (except Cat. Nos. 228, 229, and 241 series - 8" O.D.).  
Alzak is a registered trademark of Alcoa Corp.  
Note: In Canada when insulation is present,  
Type IC fixtures must be used.

 JUNO IC housings meet IECC Energy Code requirements per ASTM E283.  
Air-Loc® rated trims are pre-gasketed for minimum air leakage with IC housings.

♦ UL Listed for use in wet location.

\*\* NOTE: TR6 Trim Ring compatible with 244S, 247S trims.

Housing and trim can be ordered together or separate, but will always ship separately.