



DENALI AIRE®

OWNER'S MANUAL

SINGLE-ZONE QUICK CONNECT DUCTLESS MINI-SPLIT SYSTEM



9-24K



36K

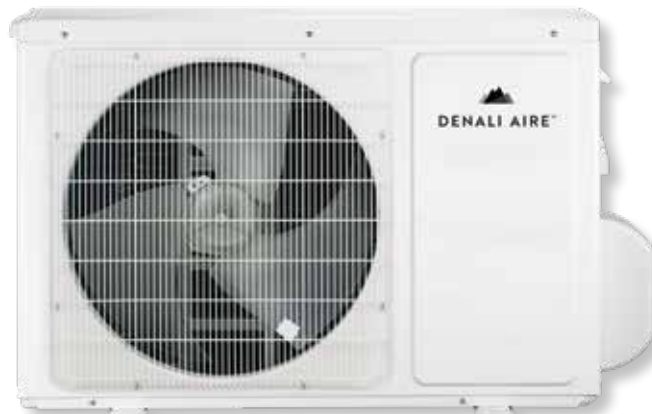

MODELS: DNMSHQ09A, DNMSHQ12A, DNMSHQ18, DNMSHQ24, DNMSHQ36-2

IMPORTANT NOTE: Read the manual carefully. Make sure to save this manual for future reference.
Illustrations in this manual are for explanatory purposes only, your actual product may look slightly different.

Contents

Safety Instructions	1
Preparation Before Use	3
Safety Precautions	4
Pre-Planning Steps	5

Installation Instructions

Mark the Wall Using Template	9
Install Wall Bracket	9
Drill Hole to Pass the Line Set Bundle Through the Wall	10
Install the Wall Unit on the Mounting Bracket	10
Secure the Outdoor Condenser	11
Unroll the Line Set, Connect Copper Refrigerant Lines, Remove Condenser Valve Caps and Open Condenser Valves	13
Remove the Electrical Cover on the Side of the Condenser	16
Connect the Molex Plug	16
Connect the Power Supply	16
Connect the Drain Tube	17
Go Inside and Turn on the Wall Unit	17
Check for Leaks	17
Set-Up Smart Controls	18
Maintenance	19
Protection	20
Troubleshooting	21
Identification of Parts	22
Display Introduction	23

For detailed remote control instructions, see the remote control manual.

Safety instructions

1. To guarantee the system will function properly, please read this manually carefully before installation.
2. Properly ground the air conditioner.
3. Check connecting wires and pipes carefully, making sure they are secured before connecting power to the air conditioner.
4. After installation, the consumer must operate the air conditioner correctly according to this manual.
Required Fuse for the System:

Model	Max. Fuse of Outdoor Unit
9k BTU	25A 115V
12K BTU	25A 115V
18K BTU	20A 230V
24K BTU	30A 230V
36K BTU	30A 230V

5. Warning: Risk of electric shock may cause serious injury or death; disconnect all electric power supply before servicing.
6. The maximum length of the connecting pipe between the indoor and outdoor unit is 25 ft.
7. The appliance is not intended for use by persons (including children) with reduced physical, sensory or mental capabilities, or lack of experience or knowledge, unless they have been given supervision or instruction concerning the use of the appliance by a guardian. Children should be supervised to ensure they do not play with the appliance.
8. This appliance can be used by children aged 8 or above, and persons with reduced physical, sensory or mental capabilities if they have been given supervision or instruction concerning safe use of the appliance and understand the hazards involved. Children should not play with the appliance. Cleaning and user maintenance should not be made without supervision.
9. Batteries for the remote control must be recycled or disposed of properly. For disposal of scrap batteries, please discard batteries as sorted municipal waste at an accessible collection point.
10. The appliances must be fitted with disconnection from the supply mains having a contact separation in all poles that provide full disconnection under over-voltage category III conditions. This must be incorporated in proper wiring in accordance with wiring guidelines.
11. If the supply cord is damaged, it must be replaced by the manufacturer, its service agent or similarly qualified persons in order to avoid hazard.
12. The appliance should not be installed in a laundry room.
13. The appliances shall be installed in accordance with local electrical safety regulations and National Electrical Codes (NEC).
14. The air conditioner must be installed by a professional or a qualified person.

Preparation before use

Safeguarding the environment

This appliance is made of recyclable or re-usable material. Scrapping must be carried out in compliance with local waste disposal regulations.

For more detailed information on handling and recycling this product, contact your local waste management offices.

This marking indicates that this product should not be disposed of with other household waste items throughout North America. To prevent possible environmental or human harm from uncontrolled waste disposal, recycle responsibly to promote the sustainable reuse of material resources.

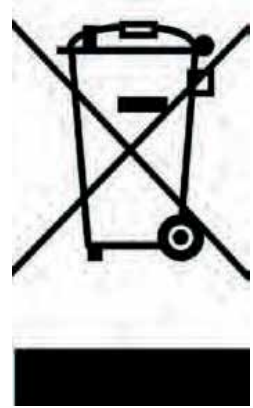









Preparation before use

Tools Needed

- Pencil/ Nail to mark wall
- Level
- Drill
- Stud Finder
- Phillips Head Screwdriver
- Dry Wall Anchors & Screws
- 2.5" Hole Saw
- 2 Adjustable wrenches
- 5 mm Allen Wrench
- Duct Tape
- Surge Protector (optional/ highly recommended)

Box Part Breakdown



Indoor Unit Box

	1x Indoor Evaporator Unit
	1x Mounting Bracket + Template
	1x Optional Extra Foam Insulation (For insulating valve connections)
	1x Drain Joint
	1x Drain Joint Rubber Seal
	4x Flare Nuts (For conventional installations)
	1x Bag of Wall Anchors & Screws
	1x Remote Control Wall Bracket

Outdoor Unit Box

	1x Outdoor Condenser
	1x Drain Tube
	1x Duct Seal (Use provided duct seal to fill any gaps)
	1x Vinyl Wrap (For a cleaner look, vinyl wrap may be used; some models may have 2 wraps)
	1x Wall Collar
	4x Condenser Anti-Vibration Pads

Line Set Box

	1x 25 ft. Line Set
	2x Male Condenser Couplers

Safety precautions

Symbols in this Use and Care Manual are interpreted as shown below.

 Do NOT do

 Watch out for the following situation

 Grounding is essential.

 Warning: Incorrect handling could cause serious hazards such as serious injury or even death

 Use the correct power supply in accordance with the rating plate requirements. Otherwise, serious faults or hazards may occur, or fire may break out

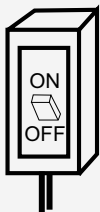

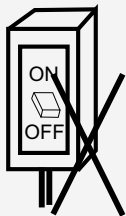

 Keep the power supply circuit breaker or plug away from dirt or debris. Firmly and correctly connect power supply cord to circuit breaker, to avoid fires and electric shock due to insufficient contact.



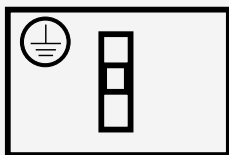

 Do not use the power supply circuit breaker or pull the plug to turn off system during operation. The sparks created may cause fire



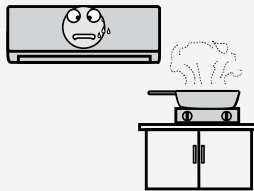

 It is the user's responsibility to ground the appliance according to local codes or ordinances by a licensed technician.

 It may be harmful to your health to allow cool air to blow directly on a person for long period of time. It is advised to allow air to flow unrestricted throughout the room.



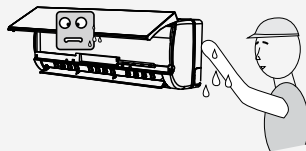

 Prevent air flow from the indoor unit (evaporator) from reaching gas burners or stoves.





 Do not touch any part of the system with wet hands.



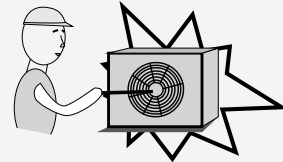

 Turn off the system by remote control first before cutting off power supply in cases of malfunction.

 Never insert a stick or similar object into the condensing unit. As the fan inside rotates at a high speed, injury may occur when obstructed.

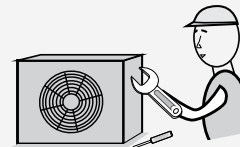

 Do not repair the system by yourself, hire a qualified HVAC technician. If repairs are done incorrectly, this may result in electric shock and voiding of the warranty.



 Do not put any object on top of the outdoor condensing unit

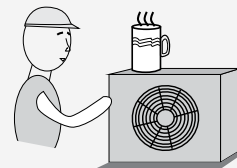

 Do not cut, pull, or press the power supply cord, as it may break. An electric shock or fire can be caused by a broken power supply cord.



Pre-Planning Steps

Installation diagram

Distance from wall should be over 4.75 inches

Distance from ceiling should be over 6 inches

Distance from the wall should be over 4.75 inches

Distance from floor should be over 98 inches.

Air intake distance from the wall should be over 10 inches

Air intake distance from the wall should be over 10 inches

air outlet distance from the wall should be over 20 inches

over 10 inches



- Above figure is a simple presentation of the unit, it may not match the external appearance of the unit you purchased.
- Installation must be performed in accordance with the national wiring standards by authorized personnel only.

Pre-Planning Steps

Choose where to install the indoor wall unit

Before installing the indoor unit, you must choose an appropriate location. The following are standards that will help you choose an appropriate location for the unit:

Find an area on an exterior wall, at least 6 inches from the ceiling and 4.75 inches from the adjacent wall. The location should also meet these standards:

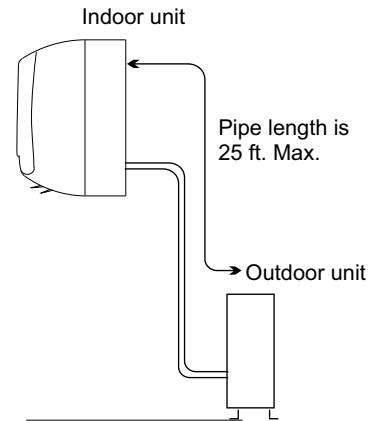

- A location within 25 ft. of the outdoor condenser.
- A space with good air circulation.
- A space with convenient drainage for indoor condensate (tube that will go to the outside with the line set bundle).
- A location where noise from the unit will not disturb you or others.
- A wall strong enough to support the weight of the unit:
 - Use a stud finder to locate studs to ensure area is strong enough to support the unit
 - If a stud cannot be found in the desired area, you will need to use wall anchors
- A location at least 3.5 feet from all other electrical devices (e.g., TV, radio, computer)
- **Do NOT install the unit in the following locations:**
 - Near any source of heat, steam or combustible gases.
 - Near flammable items such as curtains or clothing.
 - Near any obstacles that might block air circulation.
 - Near a doorway.
 - In a location in direct sunlight.
- **Note about the wall hole:**

While choosing a location, be aware that you need to leave ample room for a wall hole to pass the communication cable and refrigerant piping (line set) that connect the indoor and outdoor units. The default position for all piping is the right side of the indoor unit (while facing the unit).

Pre-Planning Steps

Choose where to install the outdoor condenser

Before installing the outdoor unit, you must choose an appropriate location. The following are standards that will help you choose an appropriate location for the unit:

- An area with good air circulation and ventilation.
- A firm and solid location to support the unit and prevent from vibration.
- An area where noise from the unit will not disturb you and others.
- An area protected or away from prolonged periods of direct sunlight or rain.

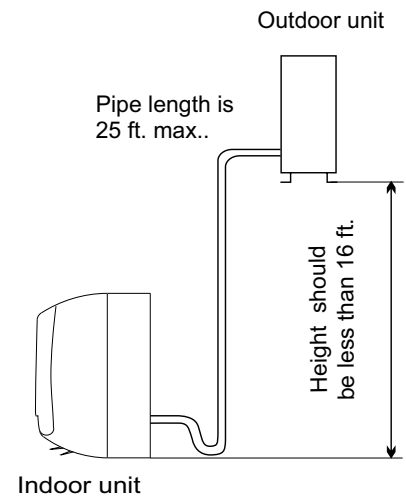

Do NOT install the unit in the following locations:

- Near an obstacle that will block air inlets and outlets.
- Near a public street, in alley ways, crowded areas or where noise from the unit will disturb others.
- Near animals or plants that may be harmed by hot air discharge.
- Near any source of combustible gas or flammable materials.
- Near a heat source or ventilation fans.
- In a location that is exposed to large amounts of dust.
- In a location exposed to an excessive amount of salty air.

Special considerations for extreme weather:

If the condenser will be exposed to heavy wind:

Install unit so that air outlet fan is at a 90° angle (adjacent) to the direction of the wind. For extremely heavy winds, build a barrier in front of the condenser for added protection.

If the condenser will frequently be exposed to heavy rain or snow:

Build a shelter above the unit to protect it from rain or snow, be careful not to obstruct airflow around the unit.

Pre-Planning Steps

Power Supply

Before beginning installation of your mini-split is important to make sure you have enough room in your electric panel to support the system. If you are unsure about your location's electrical capabilities, call a certified electrician.

Model	Max. Fuse of Outdoor Unit
9k BTU	25A 115V
12K BTU	25A 115V
18K BTU	20A 230V
24K BTU	30A 230V
36K BTU	30A 230V

Recommended Power Surge Protection

To ensure proper function and the longevity of your mini split, a single-phase surge protector is highly recommended on the disconnect box to prevent electrical failure.

In the case of unpredicted power fluctuations, power surges or other electrical mishaps, a surge protector can help protect your mini-split from damage.



Installation Instructions

1. Mark the wall using provided template

The mounting bracket is the device on which you will mount the indoor unit, it is the silver bracket on the back of the indoor unit. A mounting template has been provided to assist you with proper hole and evaporator (indoor unit) placement.

In the location chosen during pre-planning, locate studs in the wall using a stud finder. If you cannot find a stud, you will need to use wall anchors.

1. Place the mounting plate template against the wall, in a location:

- On an exterior wall, at least 6 inches (15.25 cm) from the ceiling and 4.75 inches (12 cm) from adjacent wall (refer to figure 1.1)
- Where two studs can be drilled directly into to support the mounting bracket
- Where the line set hole, as marked on the template, will be free of electrical wiring, plumbing, and other sensitive components that may be hidden in the wall

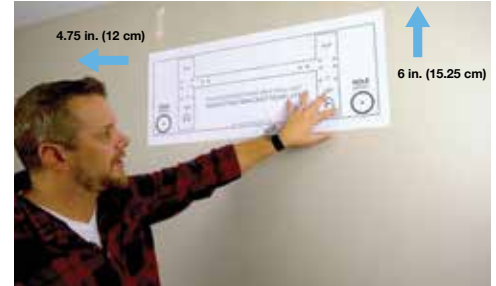

Figure 1.1

NOTE: We strongly advise using the hole located on the right side of the template, as this is where the indoor unit will have the line set bundle located. If you choose to move the bundle to the left side of the unit, then you will need to make your line set connections inside, before mounting the unit.

2. Use a level to make sure your template is level.

3. Using something sharp like a nail, mark the areas of the wall where you will be drilling your screws and the line set hole.

4. Remove the mounting plate from the wall.

2. Install Wall Bracket

1. Detach the silver mounting bracket attached to the back of your indoor head unit.
2. Line up the bracket with the screw and hole locations marked previously on your wall.
3. Mount the bracket on the wall using the 6 screws provided. Be sure that you are screwing directly into the two studs found earlier. If your wall does not have a stud, you will need to use wall anchors (Mollys) to secure the mounting bracket. (see figure 2.1)

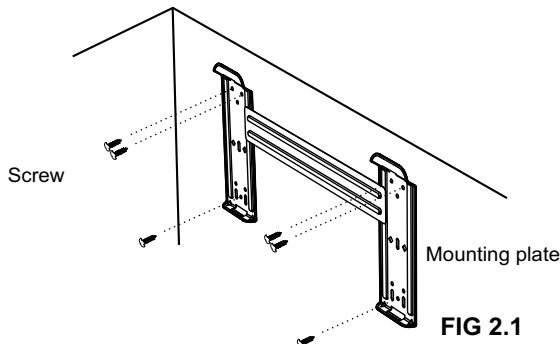

FIG 2.1

CONCRETE OR BRICK WALLS:

If the wall is made of brick, concrete, or similar material, drill 1/4 in diameter holes in the wall and insert the sleeve anchors provided. Secure the mounting plate to the wall by tightening the screws directly into the wall anchors.

Note: The shape of your mounting plate may be different from the one above, but the installation method is similar.

Installation Instructions

3. Drill hole to pass the line-set bundle through the wall

CAUTION: When drilling the wall hole, you will need to make sure to avoid electrical wiring, plumbing, and other sensitive components that may be hidden in the wall.

1. Using a 2.5 in. (63.5mm) core drill, drill a hole in the wall (Fig 3.1). Make sure that the hole is drilled at a slight downward angle so that the outdoor end of the hole is lower than the indoor end by about 1/2 in. (5 – 7mm) to ensure proper drainage for water condensation.
2. From the outside, place the protective wall cuff/ sleeve in the hole. This protects the edges of the hole and seals it when you finish the installation process.

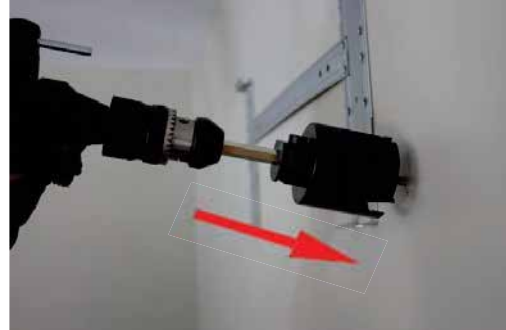

4. Install the wall unit on the mounting bracket

The communication cable, the beginning of the drain tube and the beginning of the copper line set is inside an insulated sleeve attached to the back of the unit. You must prepare the bundle before passing it through the hole in the wall.

1. Grip the refrigerant copper piping at the base of the bend.
2. Slowly, with even pressure, bend the piping perpendicular to the head unit. Do not kink or damage the piping during the process.
3. **CAUTION:** Be extremely careful not to kink or damage the piping while bending them away from the unit. Any kinks in the piping will affect the unit's performance.

Preparing the Bundle

Before passing the refrigerant piping, drain hose and communication cable through the wall hole, you must bundle them together to save space. Make sure that the drain hose is at the bottom of the bundle. Putting the drain hose at the top of the bundle can cause the drain pan to overflow and backup, which can lead to fire, water damage or both. (FIG 4.1)

1. Double-check that the ends of the refrigerant pipes are sealed with blue and gray caps, preventing dirt or foreign materials from entering the pipes. Do not remove these caps.
2. Slowly pass the wrapped bundle of refrigerant pipes, drain hose, and communication cable through the hole in the wall. (FIG 4.2)
3. Hook the top of the indoor unit on the top hook of the mounting plate.
4. Check that the unit is hooked firmly on mounting plate by applying slight pressure to the left and right sides of the unit. The unit should not move or shift.
5. Using even pressure, push down on the bottom half of the unit. Keep pushing down until the unit snaps onto the hooks along the bottom of the mounting plate.
6. Double-check that the unit is firmly mounted by applying slight pressure to the left and the right sides of the unit.

FIG 4.1

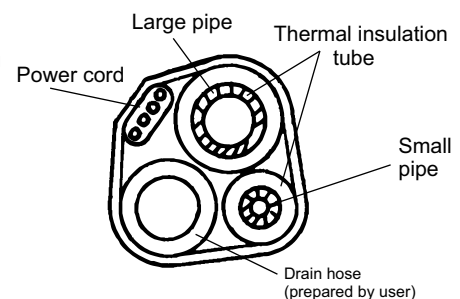

FIG 4.2



Installation instructions

5. Secure the outdoor condenser

Anchor the Outdoor Unit

The outdoor unit can be anchored multiple ways* — a pad on the ground, a wall bracket, or a stand/blocks (*not included).

Installing the unit on a condenser pad:

1. Mark the positions of the four feet.
2. Pre-drill holes for expansion bolts, clean any dust away from holes.
3. Place a nut on the end of each expansion bolt.
4. Hammer expansion bolts into the pre- drilled holes.
5. Remove the nuts from expansion bolts. Place outdoor unit on bolts.
6. Put washer on each expansion bolt, then replace the nuts.
7. Using a wrench, tighten the nuts until snug.



WARNING: WHEN DRILLING INTO CONCRETE, EYE PROTECTION IS HIGHLY RECOMMENDED.

Installing the unit on a wall-mounted bracket:

Please refer to the bracket manufacturer's directions for installation.

Installation instructions

OPTIONAL: Install Drain Joint

NOTE:

- The drain joint cannot be used unless you are mounting the condenser on a wall bracket or blocks. The condenser must be elevated to accommodate the drain joint.
 - The drain joint is optional. if you would like to redirect water from the condenser to another location, install the drain joint.
 - The drain joint only needs to be used if you need to redirect water.
1. Fit the rubber seal to the end of the drain joint that will connect to the outdoor unit.
 2. Insert the drain joint into the hole in the base pan of the unit.
 3. Rotate the drain joint 90° until it clicks in place facing the front of the condenser, away from the house.
 4. Connect a 3/8" ID drain hose (not included) to the drain joint to redirect water from the condenser during heating mode.

FOR COLD CLIMATES

In cold climates, make sure that the drain hose is as vertical as possible to ensure swift water drainage. If water drains too slowly, it can freeze in the hose and flood the unit.

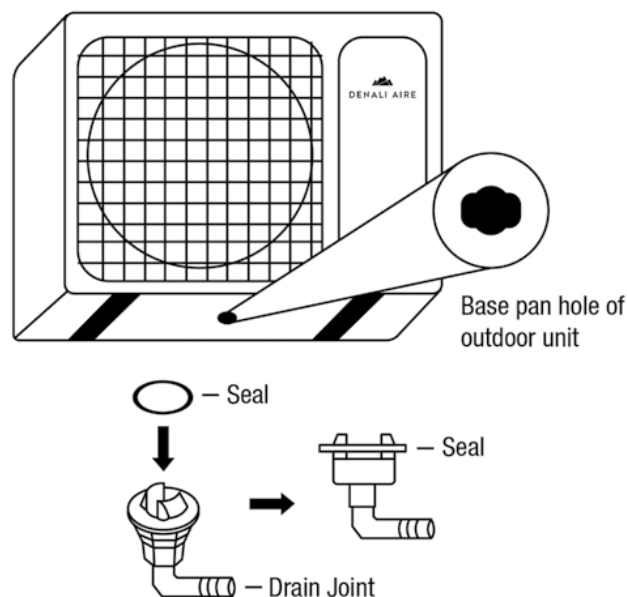

Installation instructions

6 - 9: Unroll the line set, connect the copper refrigerant lines, remove condenser valve caps and open condenser valves

CAUTION: For your safety, always wear goggles and work gloves when connecting the pipes.

UNROLLING THE LINE SET:

1. Locate line-set box, remove it from the packaging.
2. Once out of the box, carefully unroll the line-set to its full extent.

CAUTION: Be extremely careful not to kink or damage the copper piping while unrolling the line set. Any kinks in the piping will affect the unit's performance.



CONNECTING THE REFRIGERANT LINESET TO OUTDOOR AND INDOOR UNIT

Important Information — Read Before Proceeding

Follow the detailed instructions for connecting the refrigerant pipes to the indoor unit and outdoor unit. The warranty is only honored if the lines are installed correctly as described in the instructions.

- Do not remove the sealing caps until immediately before you install the lines.
- To prevent leaks, ensure that the male condenser couplers are completely free of dirt. Moisture or foreign bodies will adversely affect the function of the male condenser couplers, leading to a risk of refrigerant loss (not covered by the warranty).
- Only install refrigerant lines outdoors, in dry weather.
- The refrigerant lines must not be installed and then plastered over. Line hide can be used to help disguise the line set outdoors if wanted.
- Please make sure that refrigerant is never allowed to enter the environment. Improper handling of refrigerant may be harmful to your health and the environment. Always wear work gloves and goggles when handling refrigerant.
- Do not smoke during the installation work.
- The equipment must never be operated without the refrigerant lines connected, otherwise the equipment will be greatly damaged.
- The screw connections may only be tightened using the appropriate open-ended wrench. Remember that if they are tightened with too little torque they will leak, but if they are tightened with too much torque, the screw connections may suffer damage.
- If you are not confident about connecting the refrigerant line yourself, it is *imperative* that you contact our customer service team, refrigeration contractor or a certified HVAC technician
- **Important!** The male condenser couplers are only designed for one-time installation. Their seal can not be guaranteed if they are installed on more than one occasion. This will also void the warranty.

Installation instructions

Model	Max. allowed pipe length without additional refrigerant (ft)	Limit of pipe length (ft)	Limit of Elevation Difference H (ft)	Required amount of additional refrigerant (oz/ft)
7K~18K	25	65	32	0.22
21K~25K	25	65	32	0.32
30K,36K	25	65	32	0.43

If the height or pipe length is out of the scope of the table, please consult the dealer.

For unparalleled ease and flexibility, your Denali Aire Single-Zone Ductless Mini-Split system offers two installation options for connecting the refrigerant lines to the indoor and outdoor units. The QUICK CONNECT METHOD offers the quickest and easiest installation solution. To accommodate the many and varied installation site conditions the FLARED CONNECTION METHOD offers the option for greater installation flexibility by allowing for greater distances between the indoor and outdoor units.

IMPORTANT - This product has been designed and manufactured to meet ENERGY STAR criteria for energy efficiency only when installed using the FLARED CONNECTION METHOD and matched with appropriate coil components. However, proper refrigerant charge and proper air flow are critical to achieve rated capacity and efficiency. Installation of this product should follow Denali Aire's refrigerant charging and air flow instructions. Failure to confirm proper charge and airflow may reduce energy efficiency and shorten equipment life.

Refrigerant Line Connections

QUICK CONNECT METHOD

1. For this method you'll need the system out of the box
2. Simply connect one end of the line set to the indoor unit
3. Install the included quick connect fittings to the outdoor unit
4. Simply connect the other end of the line set to the outdoor unit

FLARED CONNECTION METHOD (Requires Certified HVAC Technician)

1. The refrigerants lines are connected using the quick connect method described above
2. Refrigerant within the system is removed and recovered
3. A flare type line set can then be installed

NOTE: The flare type of connection allows for a minimum line set length of 10' to a maximum system length of 65' depending on BTU capacity of system

4. Connect the one end of the flared line set to the indoor unit
5. Connect the one end of the flared line set to the outdoor unit

Installation instructions

1. Remove the water tray on the outdoor unit .
2. Locate the 2 male condenser couplers that are inside the line set box. Screw the male condenser couplers on to the outdoor condenser until it stops — then give it another 1/4 turn making sure it is fully secure.
3. Align the refrigerant pipes with the corresponding valves so they are not stressed. The caps are color coded to ensure the proper connection.
4. First, connect the line set to the indoor unit. Remove the caps according to color, 1 from the indoor unit, and 1 from the line set. Screw these together without cross threading them. Once they are tight, give another 1/4 turn to fully seat. These cannot be overtightened, no threads should be showing. Follow the same step to connect the other line.

ATTENTION: Once you have made the connections from the line set to the indoor head, ensure that the black lines on the fittings are aligned. If they are not you must re tighten them until they are aligned.



NOTE: the refrigerant lines must be connected to the valves on the outdoor unit and indoor unit with as little stress as possible, leave slack.

5. **IMPORTANT:** Cover up any exposed refrigerant lines with the optional extra foam insulation.

Now, connect the line set to the condenser. Tighten the bottom male condenser coupler first and then the top male condenser coupler using an open-ended wrench. (see figure 6.1)

- Ensure the screw connectors do not skew as you tighten them. See below chart for proper torque.
- **IMPORTANT:** Because the coupling works with tapping rings, it may leak if you undo and reconnect the lines — this will void the warranty.

COUPLING SIZE (Last 2 Part Numbers)	Pound Force Foot
-06 (9.5 mm dash size)	18-20 ft lbs.
-08 (12.7 mm dash size)	30-35 ft lbs.
-12 (19.1 mm dash size)	45-50 ft lbs.
-16 (25.4 mm dash size)	60-65 ft lbs.



FIG 6.1

6. Remove the cover on the top valve using an adjustable wrench. Using a 5 mm Allen key, place key inside of the valve and turn counter clockwise slowly until you reach a stop (see figure 6.2). Then screw the cap back on the top of the valve and tighten to ensure a proper seal (see figure 6.3).
7. Remove the cover on the bottom valve using an adjustable wrench. Using a 5 mm Allen key, place key inside of the valve and turn counter clockwise slowly until you reach a stop. Then, screw the cover back on the top of the valve and tighten to ensure a proper seal.



FIG 6.2

- **IMPORTANT:** The conical ring on the valve has a sealing function with the sealing seat in the caps. Take precaution not to damage the cone, and keep it free of dirt and other debris.

8. After steps 1-7, double check that all connections are properly sealed using leak detection spray or soap suds. If bubbles form, the system has a leak and the screw connectors must be tightened again using an open-ended wrench. (see pg 17 for a description of the leak test)



FIG 6.3

Installation instructions

10. Remove the electrical cover on the side of the condenser

Remove the screws and electrical cover on the side of the condenser using a Philips screw driver.

11. Connect the Molex plug

1. Connect your pre-installed communication wire from the indoor unit to the outside Molex plug. (FIG 11.1)
2. Be sure the wiring goes through one of the holes on the cover that was removed.



FIG 11.1

12. Connect the power supply

WARNING: Please read all power regulations on this page. We recommend having a qualified electrician connect power to the unit.

NOTE: 9K & 12K BTU systems are 115-volt, 18K, 24K 36K are 240-volt.

BEFORE PERFORMING ELECTRICAL WORK, READ THESE REGULATIONS

1. All wiring must comply with local and national electrical codes, and must be installed by a licensed electrician.
2. All electrical connections must be made according to the Electrical Connection Diagram located on the side panels of the indoor and outdoor units.
3. If there is a serious safety issue with the power supply, stop work immediately. Explain your reasoning to the client, and refuse to install the unit until the safety issue is properly resolved.
4. Power voltage should be within 90–110 of rated voltage. Insufficient power supply can cause electrical shock or fire.
5. If connecting power to fixed wiring, install a surge protector and main power switch with a capacity of 1.5 times the maximum current of the unit.
6. If connecting power to fixed wiring, a switch or circuit breaker that disconnects all poles and has a contact separation of at least 1/8 in. (3mm) must be incorporated in the fixed wiring. The qualified technician must use an approved circuit breaker or switch.
7. Only connect the unit to an individual branch circuit outlet. Do not connect another appliance to that outlet.
8. Make sure to properly ground the air conditioner.
9. Every wire must be firmly connected. Loose wiring can cause the terminal to overheat, resulting in product malfunction and possible fire.
10. Do not let wires touch or rest against refrigerant tubing, the compressor, or any moving parts within the unit.
11. If the unit has an auxiliary electric heater, it must be installed at least 40 in. (1 meter) away from any combustible materials.

Installation instructions

Main Electrical Connection

All wiring must comply with local and national electrical codes, and must be installed by a licensed electrician.

ATTENTION: A surge protector is needed to prevent electrical failure.

You must first choose the right cable size before preparing it for connection.

Outdoor Power Cable: H07RN-F North America

APPLIANCE AMPS (A)	AWG
10	18
13	16
18	14
25	12
30	10
40	8

Model	Max. Fuse of Outdoor Unit
9k BTU	25A 115V
12K BTU	25A 115V
18K BTU	20A 230V
24K BTU	30A 230V
36K BTU	30A 230V

CHOOSE THE RIGHT CABLE SIZE

The size of the power supply cable, signal cable, fuse, and switch needed is determined by the maximum current of the unit. The maximum current is indicated on the nameplate located on the side panel of the unit. Refer to this nameplate to choose the right cable, fuse, or switch.

Run power from the disconnect box to the unit.

13. Connect the drain tube

Connect the drain tube that comes with the condenser, use duct tape to secure the tubes together.

14. Go inside and turn on the wall unit

1. When the outside work has been concluded, be sure to re-check all wiring and valves
2. Go inside and turn on the indoor unit using the provided remote control. (FIG 14.1)
3. Set the temperature to the lowest temperature in cool mode.
4. Wait for unit to run and assure unit blows cool air and all functions and mode are in working conditions



FIG 14.1

15. Check for leaks

Once the unit is up and running it is important to check for refrigerant leaks, while the system is running double check for leaks.

There are two methods to check for gas leaks:

1. **Soap and Water Method:** Fill a spray bottle with dish soap and water. Spray all line-set connection fittings to make sure there is no bubbling, bubbling implies there is a leak.
2. **Leak Detector Method:** When using a leak detector, please refer to the device's user manual for proper instructions.

Once confirmed that no leaks are present, replace the valve cover on the outside condenser.



Installation instructions

16. Set up smart controls

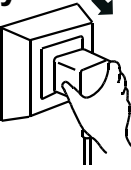
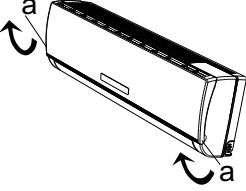

Please refer to the Denali Aire Application installation manual for further instructions.

Maintenance

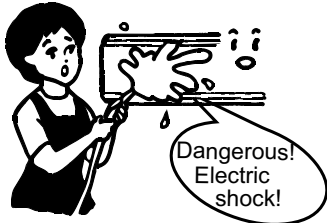
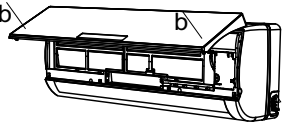
◆ Front panel maintenance

<p>1 Cut off the power supply</p> <p>Turn off the appliance first before disconnecting from the power supply.</p> 	<p>2</p> <p>Grab the points marked "a" and pull outward to remove the front panel.</p> 
<p>3 Wipe with a soft, dry cloth.</p> <p>Use a soft, dry cloth to clean the front panel if dirty.</p>  <p>Use a dry, soft cloth to clean it.</p>	<p>4 Never use volatile substances such as gasoline or polishing powder to clean the appliance.</p> 
<p>5 Never sprinkle water onto the indoor unit</p>  <p>Dangerous! Electric shock!</p>	<p>6 Reinstall and shut the front panel.</p> <p>Reinstall and shut the front panel by pressing points labeled "b" downward.</p> 

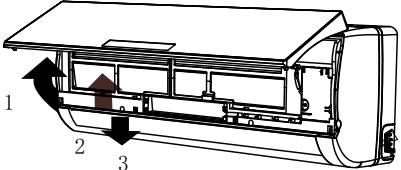
◆ Air filter maintenance

<p>1 Stop the appliance, cut off the power supply and remove the air filter.</p>  <ol style="list-style-type: none">1. Open the front panel.2. Press the handle of the filter gently from the front.3. Grab the handle and slide out the filter.	<p>2 Clean and reinstall the air filter.</p> <p>If dirt is present, wash filter with a solution of soft-detergent and lukewarm water, or clean with vacuum. After cleaning, dry well in a shaded area.</p> 
<p>3 Close the front panel again.</p> <p>☑ <i>Clean the air filter every two weeks if the air conditioner operates in an extremely dusty environment.</i></p>	<p>It is necessary to clean the air filter after using it for 250 hours or more in a dirty environment.</p>

Protection

◆ Operating condition

Operating temperatures

Temperature		Cooling operation	Heating operation	Drying operation
Indoor temperature	max	89.6°F (32°C)	80.6°F (27°C)	89.6°F (32°C)
	min	69.8°F (32°C)	44.6°F (7°C)	64.4°F (18°C)
Outdoor temperature	max	109.4°F (43°C)	75.2°F (24°C)	109.4°F (43°C)
	min	*note	5°F (-15°C)	69.8°F (21°C)

NOTE:

* Optimum performance will be achieved within these operating temperatures. If the air conditioner is used outside the above conditions, the protective device may trip and stop operation of the appliance.

* For tropical (T3) climate condition models, the outdoor max temperature is 131°F (55°C) instead of 109.4°F (43°C).

The temperature of some products is allowed beyond this range for specific situations. Please consult the merchant. When relative humidity is above 80%, and the air conditioner is running in COOL or DRY mode with the door of window open for a long period of time, dew may drip down from the outlet.

◆ Noise pollution

- Install the air conditioner at in an area that can bear its weight for quieter operation.
- Install the outdoor unit in an area where the air discharged and the operation are not distracting for neighbors.
- Do not place any obstacles in front of the air outlet of the outdoor unit as it increases noise level.

◆ Features of protector

1. The protective device will work in the following cases.

- Wait 3 minutes before restarting operation after the unit stops, or when changing modes.
- Connect to power supply and turn on the unit at once, it may start 20 seconds later.

2. If all operation has stopped, press **ON/OFF** button again to restart, Timer should be set again as if it has been canceled.

◆ Features of HEATING mode

Preheat

At the beginning of the HEATING operation, the airflow from the indoor unit will be discharged in 2-5 minutes.

Defrost

In **HEATING** operation the appliance will defrost (de-ice) automatically to raise efficiency. This procedure usually lasts 2-10 minutes. During defrost, fans stop operation. After defrost completes, it returns to **HEATING** mode automatically.

Troubleshooting

The following cases may not always be a malfunction, please check it before asking for service.

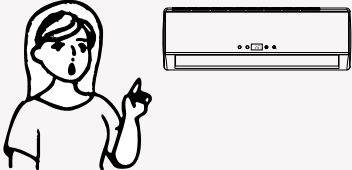
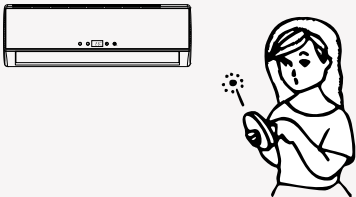
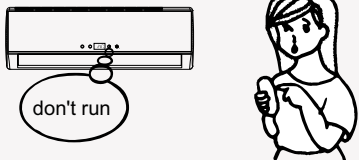
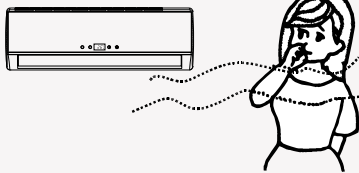
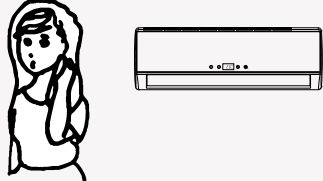
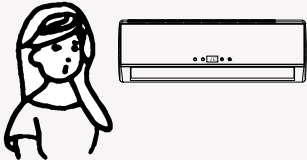
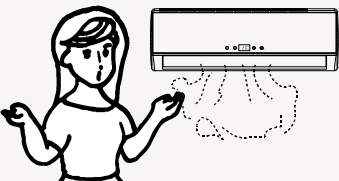
Trouble	Analysis
<p>Unit does not run</p> 	<ul style="list-style-type: none"> • If the protector trip or fuse is blown. • Please wait 3 minutes and start again, protector device may be preventing unit from working. • The batteries in the remote control may be dead.
<p>No cooled or heated air is coming out</p> 	<ul style="list-style-type: none"> • Is the air filter dirty? • Are the intakes and outlets of the air conditioner blocked? • Is the temperature set properly?
<p>Ineffective control</p> 	<ul style="list-style-type: none"> • If strong interference (from excessive static electricity discharge, power supply voltage abnormality) presents, operation will be abnormal. At this time, disconnect from the power supply and connect back 2-3 seconds later.
<p>Unit does not operate immediately</p> 	<ul style="list-style-type: none"> • Changing modes during operation will cause a 3 minute delay.
<p>Strange odor</p> 	<ul style="list-style-type: none"> • This odor may come from another source such as furniture, cigarettes etc, which are sucked in to the unit and blows out with the air.
<p>The sound of flowing water</p> 	<ul style="list-style-type: none"> • Caused by the flow of refrigerant in the air conditioner, not an issue. • Defrosting sound in heating mode.
<p>Cracking sound is heard</p> 	<ul style="list-style-type: none"> • The sound may be generated by the expansion or contraction of the front panel due to changes in temperature.
<p>Mist is spraying from the outlet</p> 	<ul style="list-style-type: none"> • Mist appears when the room air becomes very cold because of cool air discharged from indoor unit during COOLING or DRY operation mode.
<p>The compressor indicator (red) light is on constantly, and indoor fan stops.</p>	<ul style="list-style-type: none"> • The unit is shifting from heating mode to defrost. The indicator light will turn off within ten minutes and return to heating mode.

Identification of parts

Indoor unit

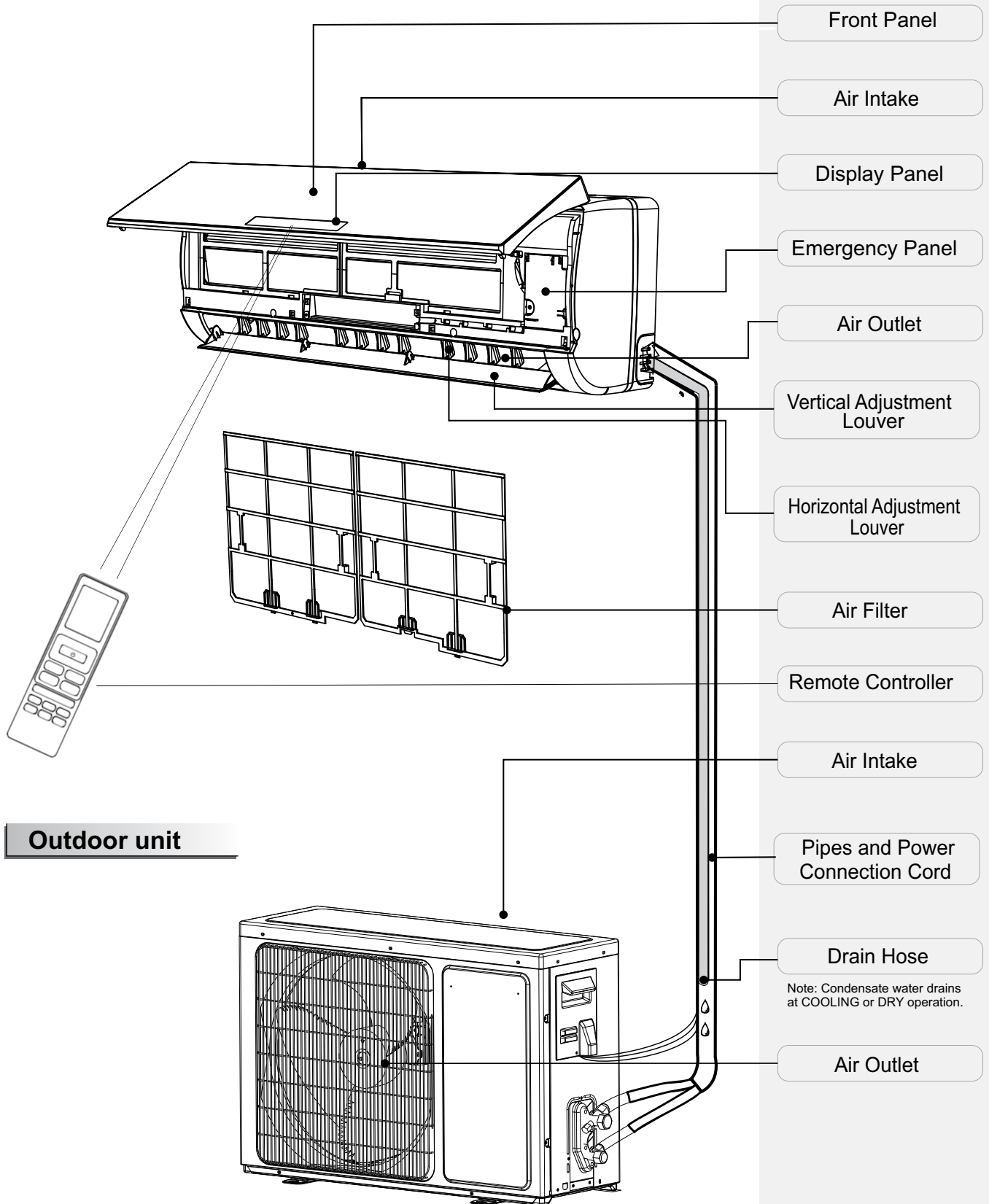

☑ The figures in this manual are based on the external view of a standard model. Consequently, the shape may differ from that of the air conditioner you have selected.

Display introduction

Display Indicator

88

- Will display set temperature
- Will display error code when error code is detected
- Will show FC when filter is to be cleaned after 200 Hrs. of run time



Running indicator

Lights up when the AC is running.
It flashes during defrosting.



Timer indicator

Lights up during set time.



Sleep indicator

Lights up in sleep mode.



Compressor indicator

Lights up when the compressor is on.

Signal Receptor

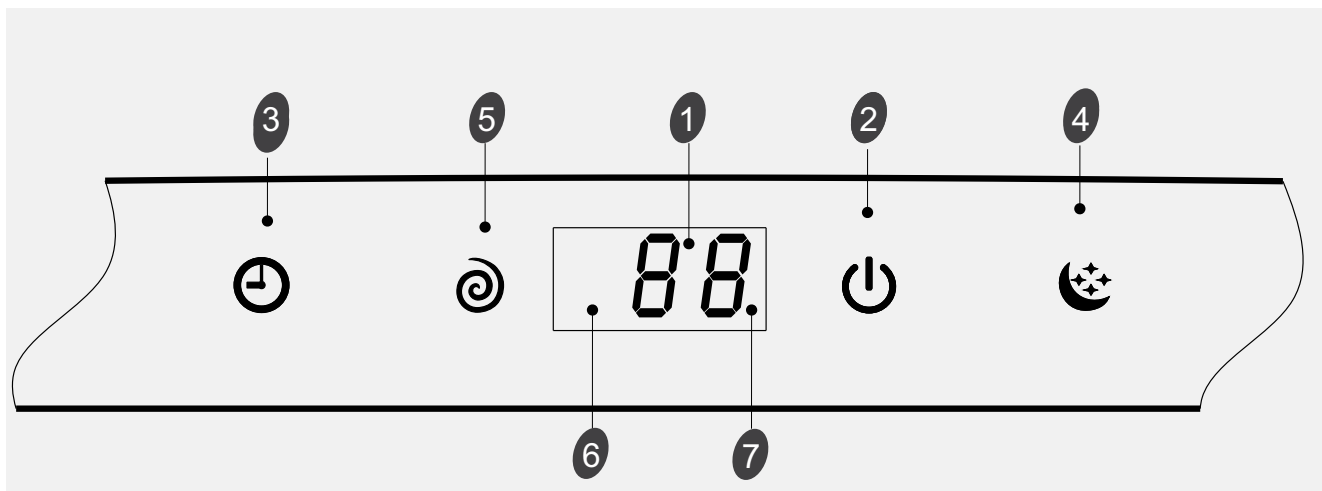

The symbols may be different from these models, but the functions are similar.

Display introduction

Emergency button **A**

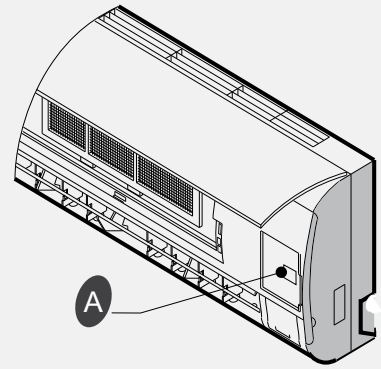

ON/OFF To let the AC run or stop by pressing the button.

☑ *The symbols may be different from these models, but the functions are similar.*



5401 Dansher Road
Countryside, IL 60525

888-597-0557 | support@denali-aire.com | www.denali-aire.com