

ASSEMBLY INSTRUCTIONS

Double Door Floor Cabinet

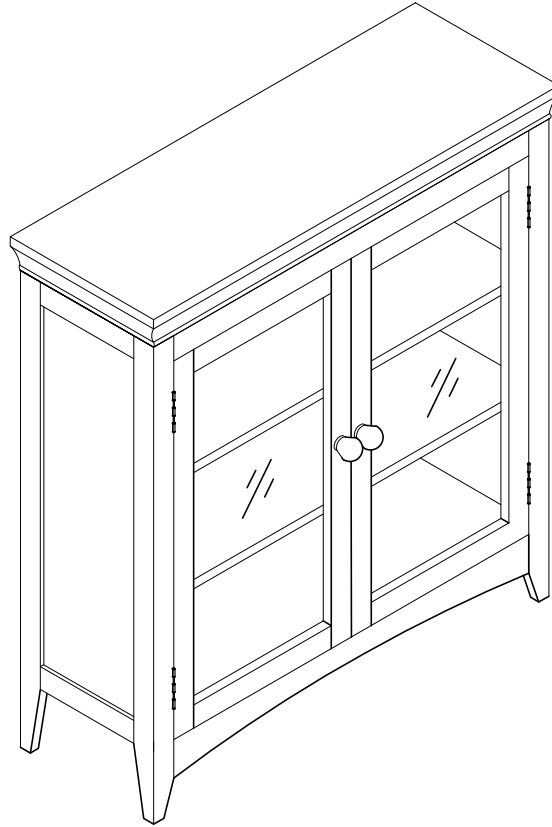

Please provide the following information when contacting for parts or questions: the name of the company you purchased from, the UPS/FedEx tracking number.

This product comes with a 1 year warranty. Products purchased second hand/used are not covered under the warranty.

ASSEMBLY INSTRUCTIONS-IMPORTANT

Carefully unpack & identify each component before attempting to assemble. Refer to parts list. Please take care when assembling the unit and always set the parts on a clean, soft surface. If you require any assistance with assembly, parts, please call the company you place order with or please email to: service@eleganthf.net

INSTRUCCIONES PARA ARMAR-IMPORANT:





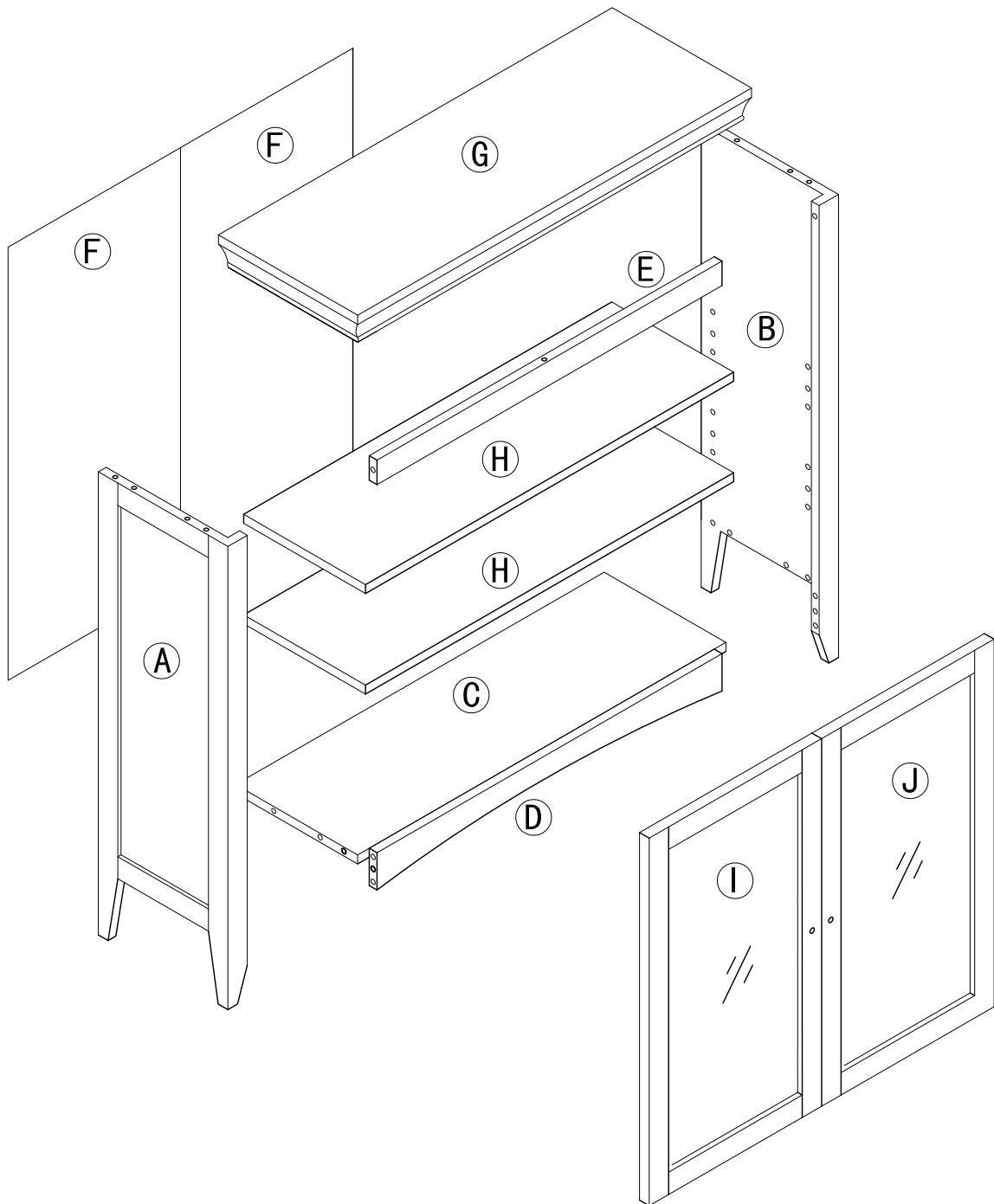

Desempaque cuidadosamente e identifique cada componente antes de tartar de empezar su ensambladura. Verifique la lista de partes. Por favor tenga cuidado cuando arme la unidad y siempre coloque las piezas sobre una superficie plana, suave y limpia. Si necesita ayuda con el armado, envíe un correo electzórico a service@eleganthf.net

DIRECTIVES DE MONTAGE-IMPORTANT:



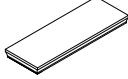
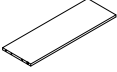
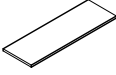





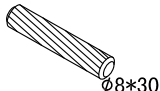

Avant de commencer l' assemblage, déballez délicatement toutes les pièces et repérez-les sur la liste des pièces. Procédez avec soins durant l' assemblage et posez toujours les pièces sur une surface proper, douce et lisse. sie vouo plait e-mail á service@eleganthf.net

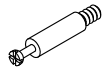

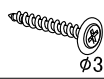
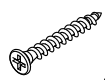
COMPONENTS

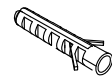
PART	FIGURE	DESCRIPTION	QTY	PART	FIGURE	DESCRIPTION	QTY
A		LEFT SIDE PANEL	1PC	F		BACK PANEL	2PCS
B		RIGHT SIDE PANEL	1PC	G		TOP PANEL	1PC
C		BOTTOM PANEL	1PC	H		ADJUSTABLE SHELF	2PCS
D		BOTTOM RAIL	1PC	I		LEFT DOOR	1PC
E		UPPER RAIL	1PC	J		RIGHT DOOR	1PC

HARDWARE & TOOLS

PART	FIGURE	DESCRIPTION	QTY	PART	FIGURE	DESCRIPTION	QTY
1	 $\phi 8 \times 30$	WOODEN DOWEL	14PCS	8		SHELF PIN	8PCS
2		CAM BOLT	10PCS	9		PLASTIC BAR	1PC
3	 $\phi 15 \times 12$	CAM LOCK	10PCS	10	 $\phi 3 \times 12$ D=7	SCREW	16PCS
4	 $\phi 4 \times 30$	SCREW	1PC	12		FIX BELT	1PC
5	 $\phi 3 \times 12$	SCREW	8PCS	13		ANCHOR	1PC
6		KNOB	2PCS	14	 $\phi 4 \times 25$	SCREW	2PCS
7		KNOB BOLT	2PCS	15		WASHER	2PCS

TOOL NEEDED:



**PHILIPS SCREWDRIVER REQUIRED
- NOT INCLUDED**

SUGGESTION:



TWO PEOPLE FOR ASSEMBLING



WARNINGS:

1. DO NOT LET ANY SHARP OBJECTS TOUCH OR RUB THE SURFACE OF THE PRODUCT.
2. WHEN ASSEMBLING, DO NOT LET CHILDREN PLAY AROUND THE WORKING AREA.
3. PLEASE CONFIRM ALL PARTS ARE CORRECT BEFORE STARTING THE ASSEMBLY PROCESS.
4. DO NOT TIGHTEN ALL BOLTS AND SCREWS COMPLETELY UNTIL THE ENTIRE UNIT HAS BEEN ASSEMBLED AND SET UP.

1



10PCS

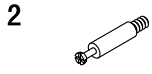

6 PCS

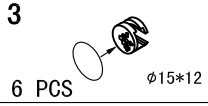

6 PCS

$\phi 15 \times 12$

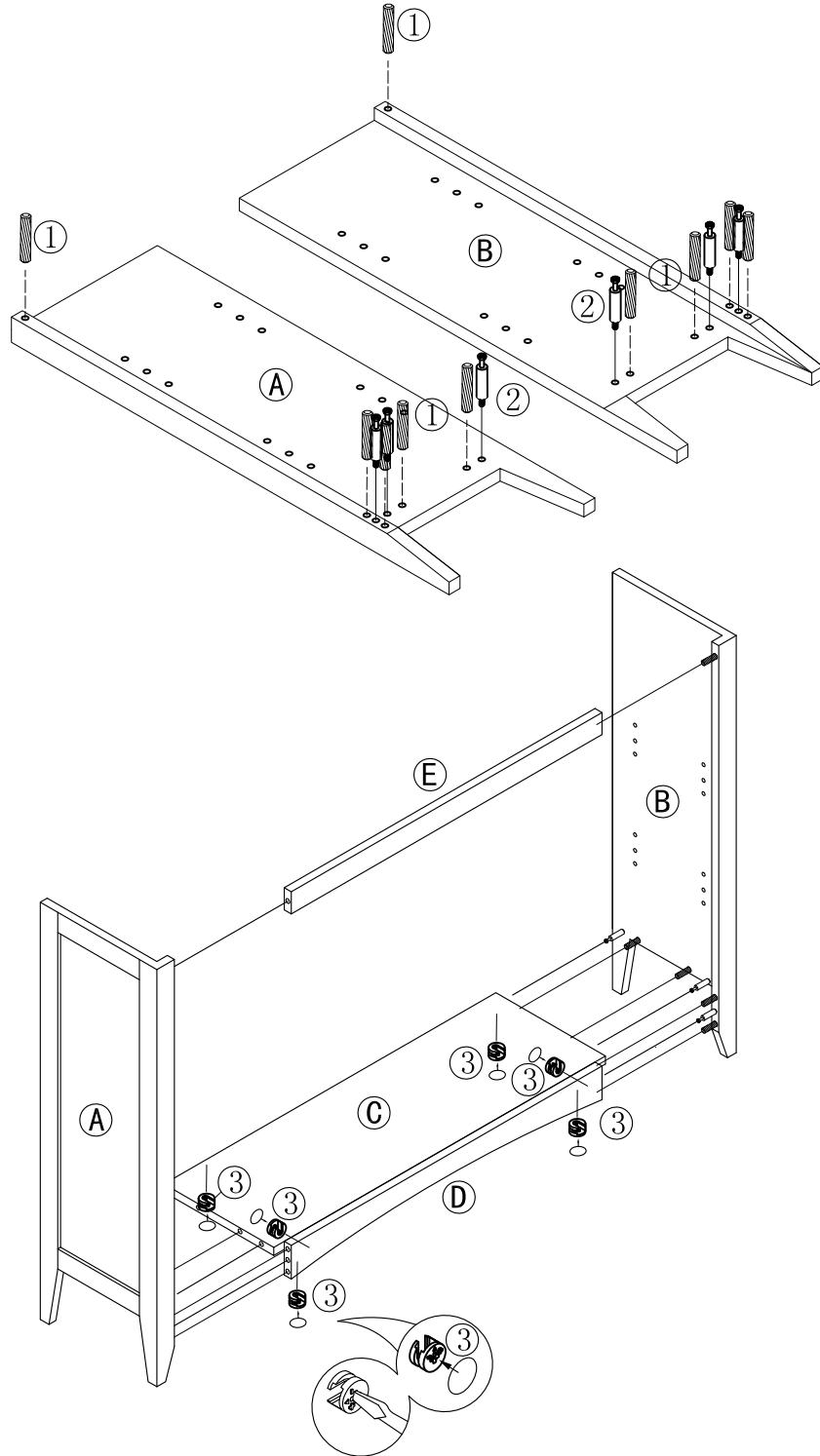

STEP 1:

1. Screw cambolts (2) and insert dowels (1) in panels A & B.
2. Attach panel C and rails E & D to panels B & C and secure with camlocks (3).

2

1



4 PCS

2



4 PCS

3



4 PCS $\phi 15 \times 12$

4



1 PC $\phi 4 \times 30$

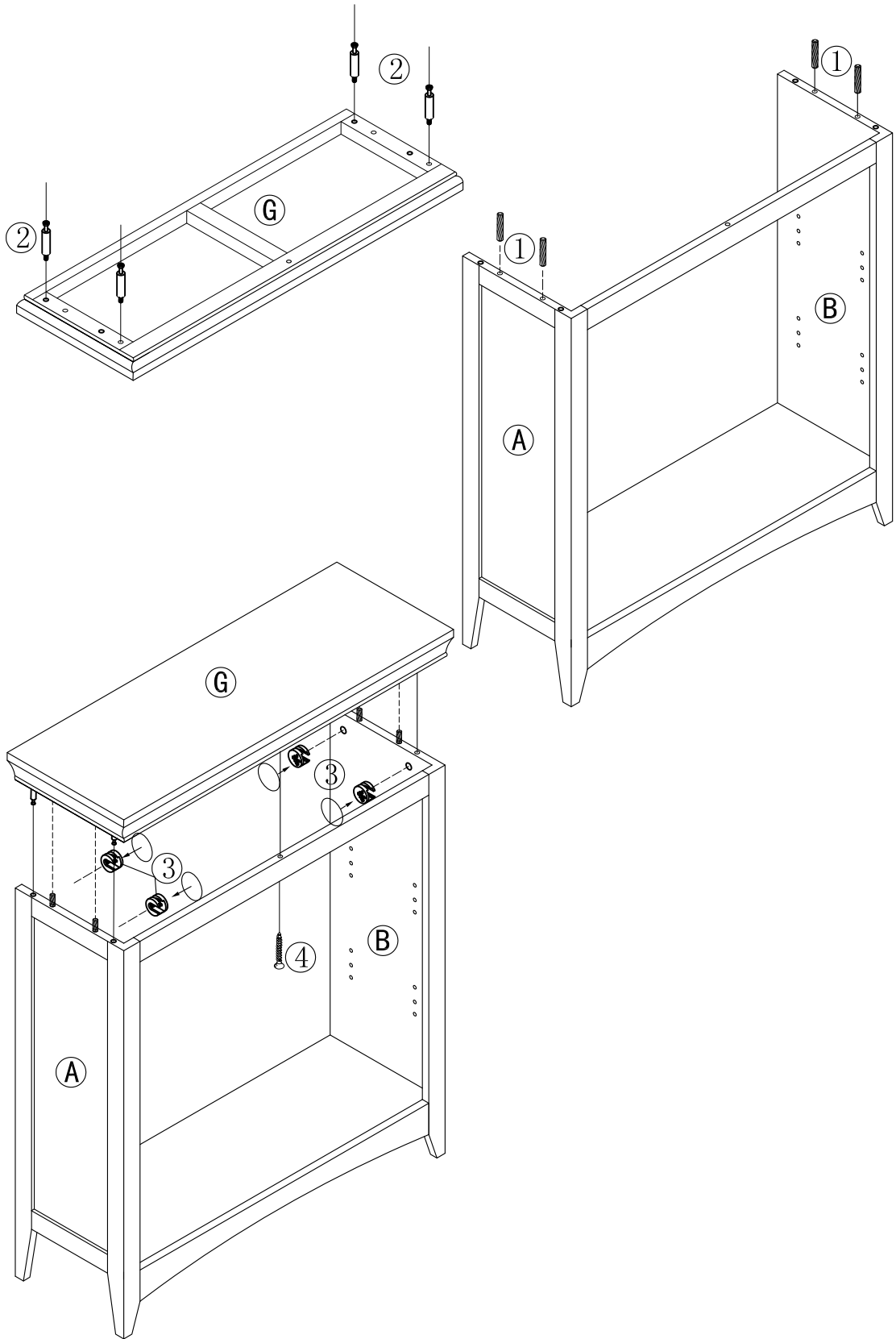

STEP 2:

1. Screw cambolts (2) into panel G.
2. Insert dowels (1) to the tops of panels A & B.
3. Attach panel G to panels A & B and secure with camlocks (3) and screw (4).

3

9



1 PC

10



16PCS $\phi 3 \times 12$ D=7

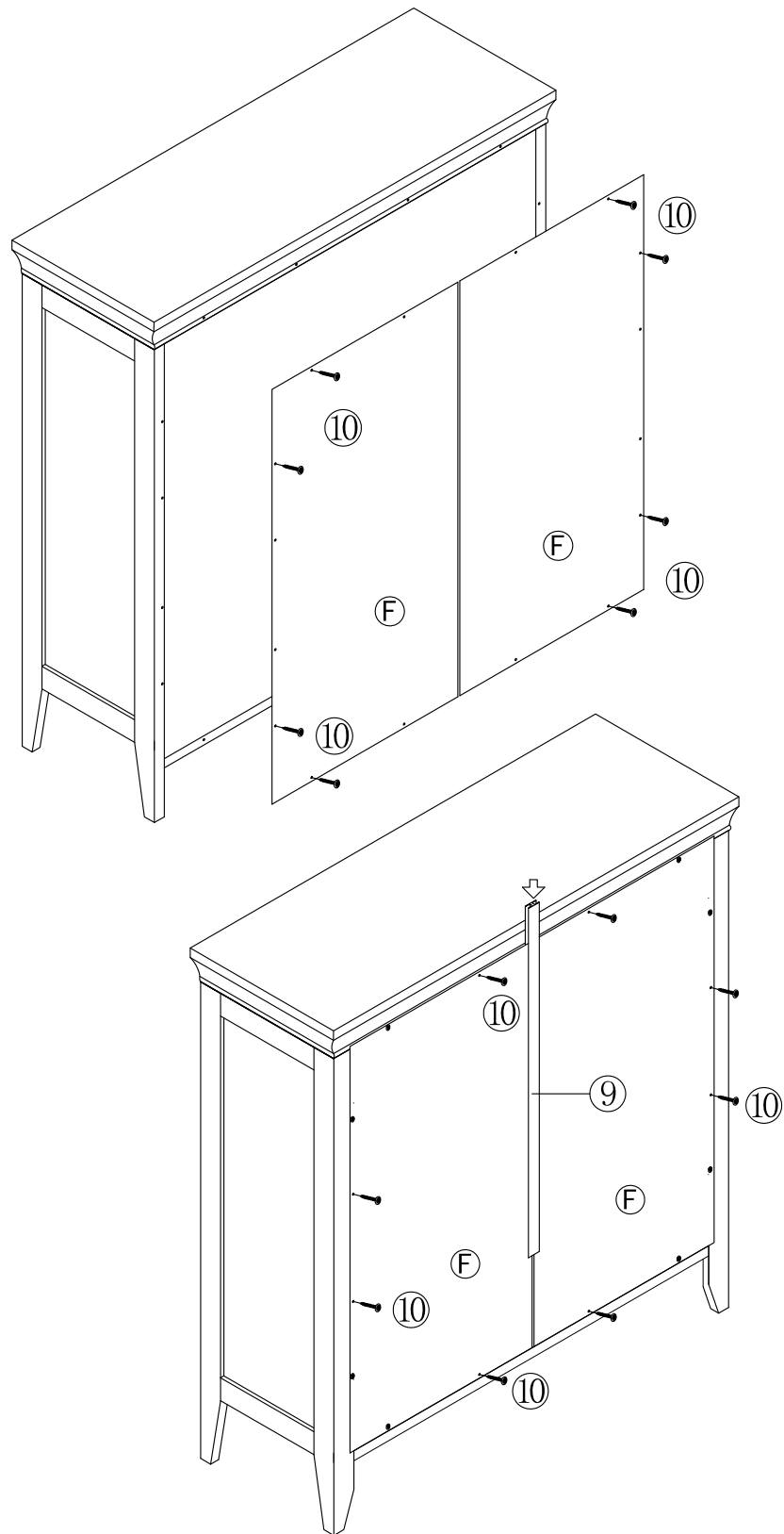

STEP 3:

1. Attach panels F to the back of the cabinet and secure with screws (10) as shown.
2. Insert plastic bar 9 as shown and finish securing panels F with screws (10).

4

5

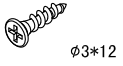

8 PCS

φ3*12

6



2 PCS

7



2 PCS

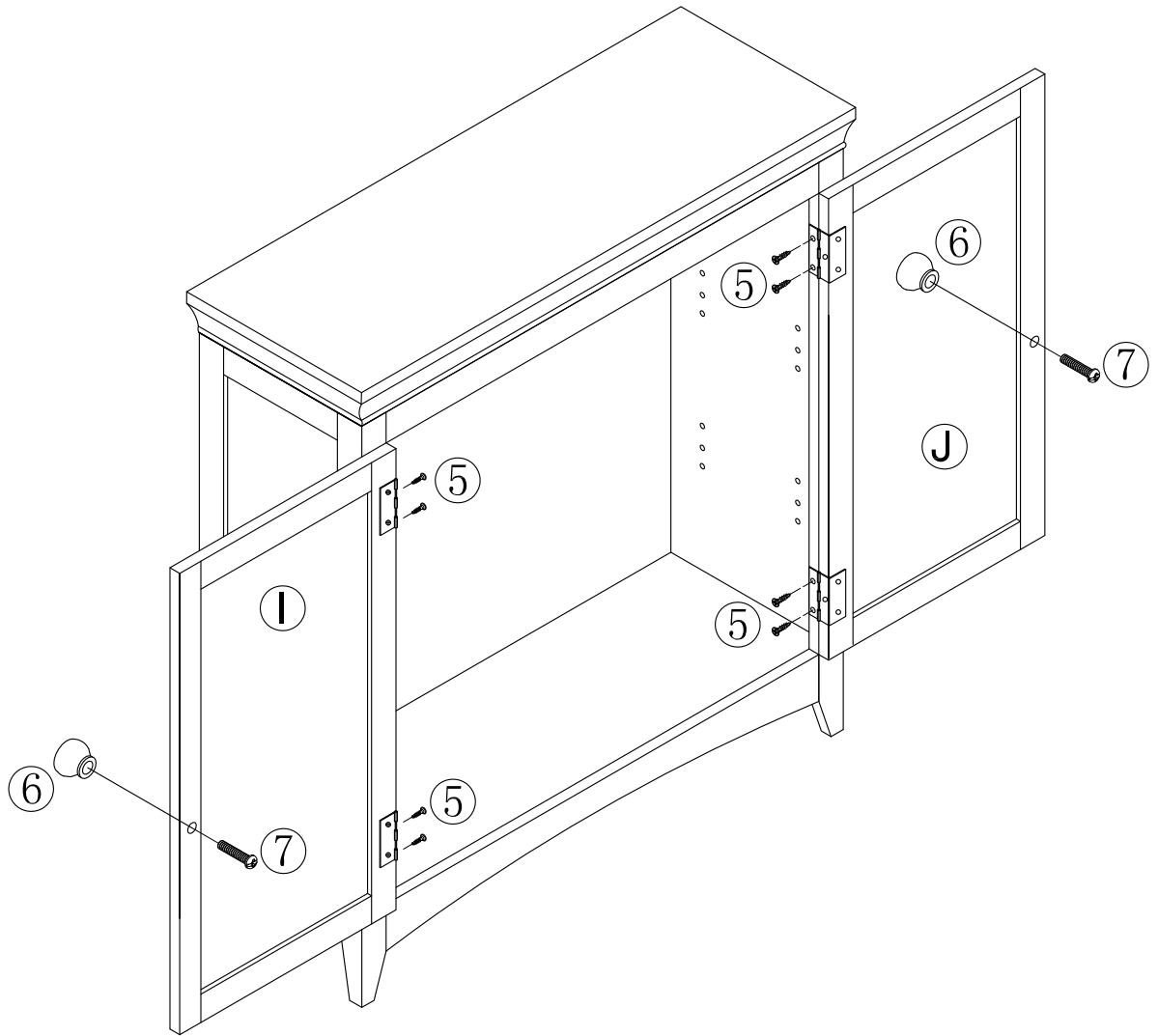

STEP 4:

1. Attach knobs (6) to doors I & J with bolts (7).
2. Attach doors I & J to the cabinet with screws (5).

5

8





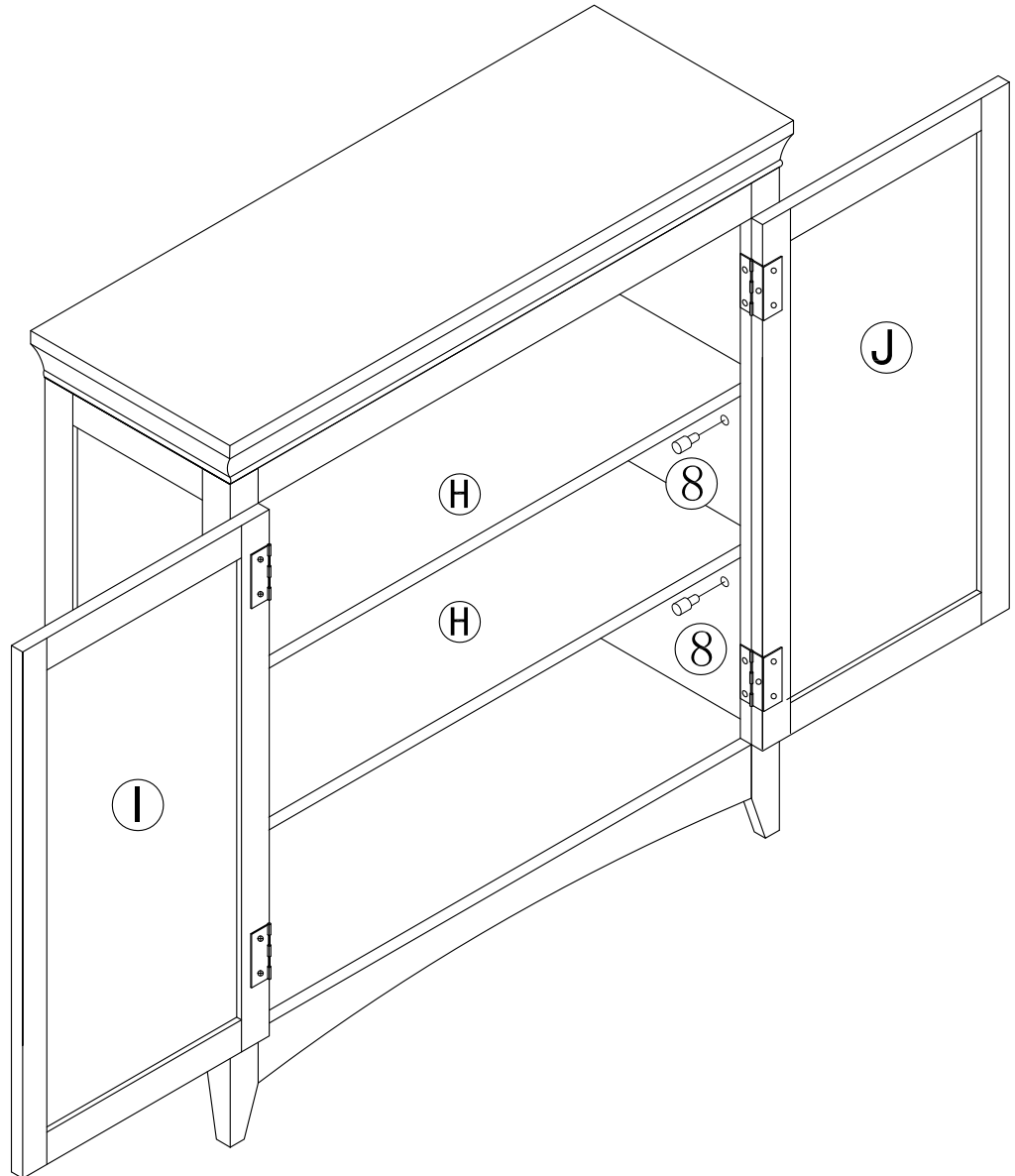

8 PCS



STEP 5:

- 1. Insert shelf pins (8) into panels A & B.**
- 2. Rest adjustable shelves H on the shelf pins.**

6

12	
1 PC	
13	
1 PC	
14	
2 PCS	ø4*25
15	
2 PCS	

