

# COSCO®

## SCENERA NEXT CONVERTIBLE CAR SEAT

Rear Facing: 2.3-18 kg and 48-102 cm  
(5-40 lb and 19-40 in.)

Forward Facing: 10-18 kg and  
74-110 cm (22-40 lb and 29-43 in.)  
and at least 1 year old

**KEEP INSTRUCTIONS FOR FUTURE USE.**

Read all instructions before using this child restraint.

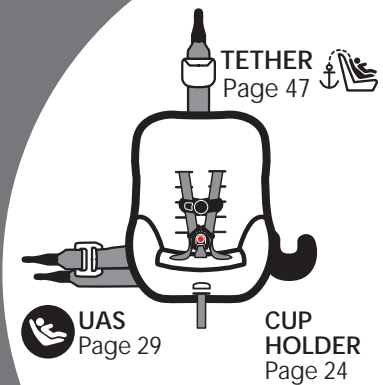

### **⚠ WARNING:**

Failure to read, understand, and follow the instructions and warnings in this instruction manual and the warnings on the system could result in serious injury or death to the child.



4358-7156 11.8.17

### Choosing Rear or Forward Facing

Your child's height, weight, and age determine how your child restraint should be placed in the vehicle. Please talk to your doctor about the best option for your child.



**REAR FACING**  
2.3-18 kg (5-40 lb)  
48-102 cm (19-40 in.)

Children up to 1 year of age must ride rear facing. The American Academy of Pediatrics recommends that children remain rear facing until they are at least 2 years old. In this child restraint, your child can remain rear facing up to 18 kg (40 lb) and up to 102 cm (40 in.).



**FORWARD FACING**  
10-18 kg (22-40 lb)  
74-110 cm (29-43 in.)  
and at least 1 year old

The American Academy of Pediatrics recommends that children remain in a five-point harness until they outgrow their forward-facing harnessed child restraint. This typically occurs around age 4, but some children outgrow them sooner and others not until later.

**⚠ WARNING:** Verify your child's weight and height (do not guess) before choosing the child restraint's placement.

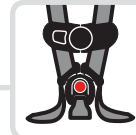

See page 3 to adjust internal harness system



UAS Belt Install  
Page 37



Vehicle Belt Install  
Page 42



UAS Belt Install  
Page 48



Vehicle Belt Install  
Page 52

## Table of Contents

### Getting Started ..... 1

Parts of the Child Restraint.....	1
Prepare Child Restraint to Fit Your Child .....	3
How Does Your Child Fit?.....	4
Changing Position of Buckle .....	6
Changing Position of Shoulder Harness Strap.....	8
Harness System Adjustments for Smaller Infants.....	10
Securing Child in Child Restraint.....	15

### General Use ..... 18

Removing Harness System .....	18
Removing Seat Pad for Cleaning.....	20
Installing Harness System.....	21
Accessories on Select Models .....	24

### Safety Information..... 25

Child Restraint Use .....	25
Installation in Vehicle .....	26
Vehicle Seating Position .....	27
Transport Canada Regulations.....	28

### Vehicle Information..... 29

Choosing UAS or Vehicle Belts.....	29
Knowing Your Vehicle Belts .....	31
Aircraft Information .....	35

### Rear Facing ..... 36

 UAS Belt Installation.....	37
 Vehicle Belt Installation.....	42

### Forward Facing..... 46

 Tether Use .....	47
 UAS Belt Installation .....	48
 Vehicle Belt Installation .....	52

### Important Information..... 55

Using a Locking Clip .....	55
Dorel Juvenile Group Information .....	57
Registration and Safety Notices .....	58
Replacement Parts Order Form.....	60
Warranty .....	62

## Parts of the Child Restraint

Front View

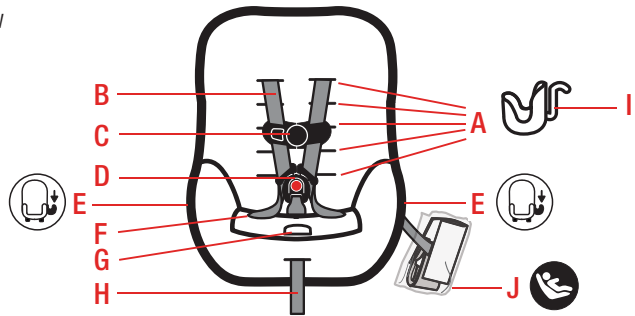

- |  |   |
|--|---|
| <b>A. Shoulder Harness Slots</b>               | <b>F. Hip Harness Slots</b>                     |
| <b>B. Harness Strap</b>                        | <b>G. Harness Release Lever</b><br>(under flap) |
| <b>C. Chest Clip</b>                           | <b>H. Harness Adjustment Strap</b>              |
| <b>D. Buckle</b>                               | <b>I. Cup Holder</b> (see page 24)              |
| <b>E. Cup Holder Attachment</b><br>(under pad) | <b>J. UAS* Belt</b> (see page 29)               |

1

Side View

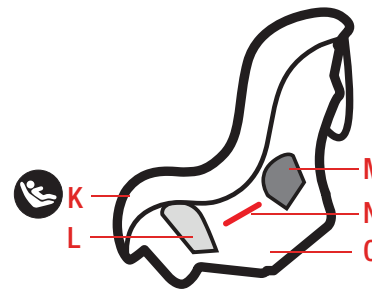

- |                                   |                                    |
|-----------------------------------|------------------------------------|
| <b>K. UAS* Belt</b>               | <b>M. Forward-Facing Belt Path</b> |
| <b>L. Rear-Facing Belt Path</b>   | <b>N. Rear-Facing Level Line</b>   |
| <b>O. Shell</b> (child restraint) |                                    |

Back View

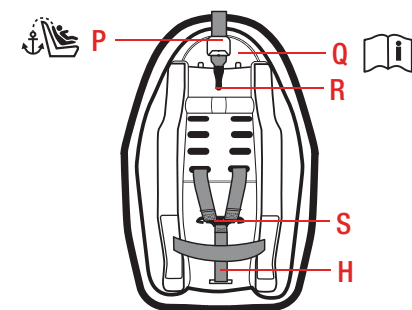

- |                                      |   |
|--------------------------------------|---|
| <b>P. Tether</b> (see page 47)       | <b>R. Tether Attachment for Storage</b> |
| <b>Q. Instruction Manual Storage</b> | <b>S. Splitter Plate</b>                |

\*Universal Anchorage System (UAS)

2

## Prepare Child Restraint to Fit Your Child



### 1. Fully Loosen Harness Strap

Push down on harness release lever (under flap on front of seat pad) while pulling out on harness strap as shown.

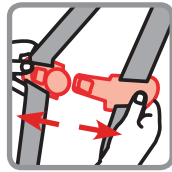

### 3. Release Chest Clip

Press on chest clip release button and pull apart. Place harness strap out of the way.



### 2. Unbuckle Harness

Press in towards the top of the red button. Pull buckle tongues out.



### 4. Place Child in Child Restraint to Determine Proper Harness Fit

The child's bottom and back should be flat against the child restraint. **See pages 4-5 for fit guidelines.**

## How Does Your Child Fit?

Use the guidelines below to determine if the buckle and harness strap are in the right place for your child.

### REAR FACING



#### Buckle Position

Start in the 1st slot and adjust outward as your child grows.

Buckle should be used in the slot closest to your child. The buckle should be not underneath or behind your child.

1st or 2nd slot **MUST** be used.



#### Harness Strap Position

Harness strap **MUST** be **at or slightly below** shoulders. Always choose the shoulder

harness slot closest to your child's shoulder height.

If the lowest shoulder harness slots are above the child's shoulders, **do not** use this child restraint.

To change the buckle position, see pages 6-7.

To change harness strap position, see pages 8-9.

To make adjustments for smaller infants, see pages 10-14.

*continued on next page* 4

## Changing Position of Buckle



### FORWARD FACING



#### Buckle Position

Start in the 1st slot and adjust outward as your child grows.

Buckle should be used in the slot closest to your child. The buckle should not be underneath or behind your child.

Any slot can be used.



#### Harness Strap Position

Harness strap **MUST** be **at or slightly above** shoulders.

Always choose the slot closest to your child's shoulder height.

If the highest shoulder harness slots are below the child's shoulders, **do not** use this child restraint.

To change the buckle position, see pages 6-7.

To change harness strap position, see pages 8-9.



#### 1. Turn Seat Over

Locate buckle's metal retainer on bottom of shell.



#### 2. Rotate Metal Retainer and Push It Up Through Shell and Pad



#### 3. From Top of Seat, Pull Buckle Out of Shell



#### 4. Insert Buckle's Metal Retainer into Slot Closest to Child

Buckle **MUST** face out.

You **MUST** use the 1st or 2nd buckle slots when child restraint is used rear facing. Any slot can be used when forward facing.

*continued on next page* 6

## Changing Position of Shoulder Harness Strap



**5. Pull Metal Retainer Completely Through Pad and Shell**

**⚠ WARNING:** Failure to place buckle's metal retainer completely through pad and shell can result in serious injury or death.



**6. Check Buckle**  
Pull up on buckle to make sure it is secured.  
The buckle **MUST** not pull out.

If you cannot achieve a snug harness fit for your child, see pages 10-14.

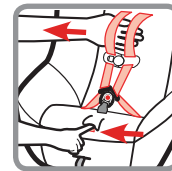

**1. Fully Loosen Harness Strap**

Push down on harness release lever (under flap on front of seat pad) while pulling out on harness strap as shown.

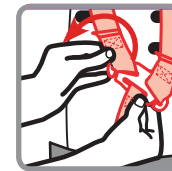

**2. From Back, Remove Harness Strap Loops From Splitter Plate**

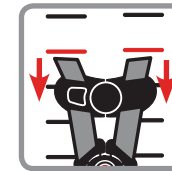

**3. Pull Harness Strap Out of Shoulder Harness Slots**

## Harness System Adjustments for Smaller Infants

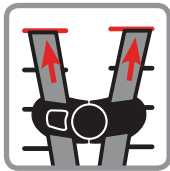

**4. Rethread Harness Strap into Correct Shoulder Harness Slots For Your Child**

See pages 4-5 for fit guidelines.

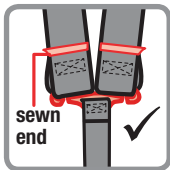

**5. Attach Harness Strap Loops to Splitter Plate**

Sewn ends of the harness strap loops **MUST** face towards you.

**DO NOT** twist harness strap or harness adjustment strap. Make sure the harness strap loops are fitted **COMPLETELY ON** both sides of the splitter plate.

**⚠ WARNINGS:** Make sure the harness height is correct for your child's size.



Do not use this child restraint rear facing unless the top of your child's head is at least 2.5 cm (1 in.) below the top of the child restraint.



Do not use this child restraint forward facing if the tops of your child's ears are above the top of the child restraint.

Failure to follow these steps can result in serious injury or death.

If you cannot achieve a snug harness fit for your child, make these adjustments.

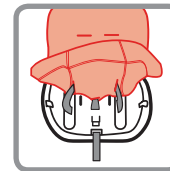

**1. Pull Up Front of Seat Pad**



**3. From Bottom of Seat, Pull Metal Retainer Towards You and Push It Up into Middle Slot As Shown**

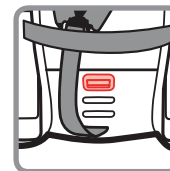

**2. With Buckle in the 1st Slot As Shown, Turn the Buckle Over**

If you need to move the buckle to the 1st slot, see page 6.



**4. From Top of Seat, Lay the Metal Retainer Flat Against the Shell As Shown**





**5. Check Buckle**

Pull up on buckle to make sure it is secured.

The buckle **MUST** not pull out.

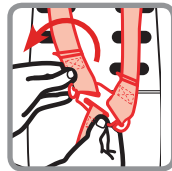

**7. From Back, Remove Harness Strap Loops From Splitter Plate**



**6. Fully Loosen Harness Strap**

Push down on harness release lever (under flap on front of seat pad) while pulling out on harness strap as shown.

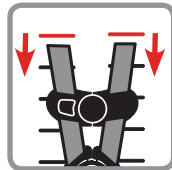

**8. Pull Harness Straps Out of Shoulder Harness Slots**

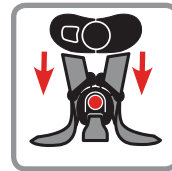

**9. Unthread Chest Clip**

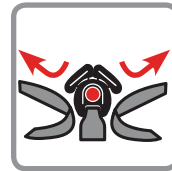

**10. Unthread Buckle**

Do not unbuckle the buckle.

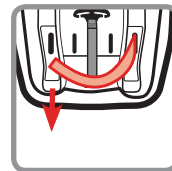

**11. Turn Seat Over and Pull Harness Strap Down and Out of Hip Harness Slot**



**12. Weave Harness Strap In and Out of Shell as Shown**

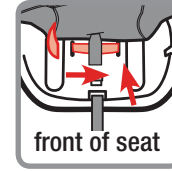

Harness strap goes behind buckle strap.

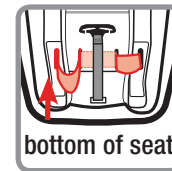

bottom of seat

*continued on next page* 12

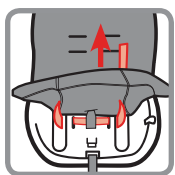

**13. Thread Harness Strap Up Through Slot in Seat Pad**

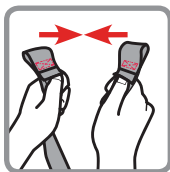

**14. Make Harness Strap Even**  
Sewn ends of harness strap loops **MUST** face each other.

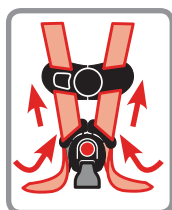

**15. Thread Buckle and Chest Clip**  
Harness strap end goes through the **back** of buckle tongues and through the chest clip **front to back** as shown.



**16. Thread Harness Strap into Correct Shoulder Harness Slots For Your Child**  
**See pages 4-5 for fit guidelines.**



**17. Attach Harness Strap Loops to Splitter Plate**  
Sewn ends of the harness strap loops **MUST** face towards you.

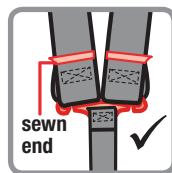

**DO NOT** twist harness strap or harness adjustment strap. Make sure the harness strap loops are fitted **COMPLETELY ON** both sides of the splitter plate.

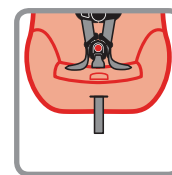

**18. Replace Seat Pad Around Front of Shell**

**⚠ WARNINGS:** Harness system must be installed correctly. Failure to follow these warnings can result in serious injury or death.



## Securing Child in Child Restraint



### 1. Place Child in Child Restraint

The child's bottom and back should be flat against the child restraint.

Position harness strap over child's shoulders and upper thighs.

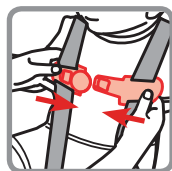

### 3. Close Chest Clip

Insert right half of chest clip into left half and snap together.



### 5. Position Chest Clip

The chest clip must be placed at mid-chest (even with armpits) and away from the child's neck.



### 6. Check Harness Tightness

Try to pinch the harness at the shoulders vertically between index finger and thumb as shown.



### 2. Buckle Harness

Push buckle tongues into buckle until you hear a "click".

Pull up on harness strap to make sure buckle is locked.

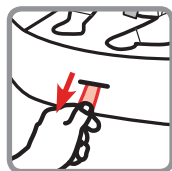

### 4. Tighten Harness

Pull on harness adjustment strap to tighten harness snugly.

**If your fingers slip off**, the harness is tight enough.

**If you can pinch the harness strap**, tighten more. The harness strap should be snug throughout its length.

A snug strap should not allow any slack. It lies in a relatively straight line without sagging. It does not press on the child's flesh or push the child's body into an unnatural position.

*continued on next page* **16**

**⚠ WARNINGS:** Failure to fasten and tighten the harness system correctly may allow the child to be ejected from the child restraint in a crash or sudden stop causing serious injury or death.

Do not mistake comfort for safety. Harness system must be snugly adjusted.



**DO NOT** put snow-suits or bulky garments on your child when placing them in the child restraint.

Bulky clothing can prevent the harness straps from being tightened properly.

#### To Remove Child From Child Restraint

1. Loosen Harness Strap
2. Unbuckle Harness
3. Release Chest Clip
4. Remove Child

## Removing Harness System



Only remove the harness system to clean the seat pad.



### 1. Fully Loosen Harness Strap

Push down on harness release lever (under flap on front of seat pad) while pulling out on harness strap as shown.

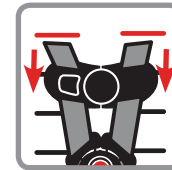

### 3. Pull Harness Strap Out of Shoulder Harness Slots

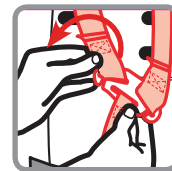

### 2. From Back, Remove Harness Strap Loops From Splitter Plate

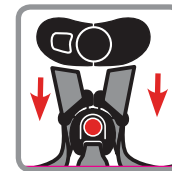

### 4. Unthread Chest Clip

## Removing Seat Pad for Cleaning



**5. Unthread Buckle**  
Do not unbuckle the buckle.

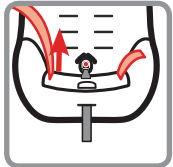

**6. Pull Harness Strap Out of Seat**

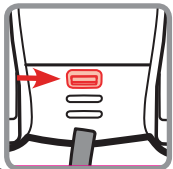

**7. Turn Seat Over**  
Locate buckle's metal retainer on bottom of shell.

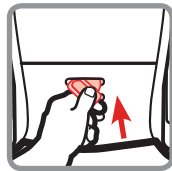

**8. Rotate Metal Retainer and Push It Up Through Shell and Pad**



**9. From Top of Seat, Pull Buckle Out of Shell**

You must remove the harness system to remove the pad from the shell. See pages 18-19.

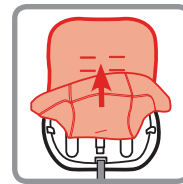

### Remove Pad

Pull pad off the bottom of child restraint and remove pad.

**⚠ WARNINGS:** Do not use child restraint without the seat pad.

Failure to do this can result in serious injury or death.

### Cleaning Pad

Machine wash separately with cold water on a gentle cycle. Do not use bleach. Tumble dry separately for 10-12 minutes on low heat. Remove immediately.

### Cleaning Harness Strap

Spot clean using warm sudsy water and damp cloth.

### Replacing Pad

Starting from bottom of child restraint, slip pad on shell. Pull harness adjustment strap through pad. Wrap pad around the top of shell. Install harness system, see pages 21-23.



## Installing Harness System

If you cannot achieve a snug harness fit for your child, see pages 10-14.



**1. Insert Buckle's Metal Retainer into Slot Closest to Child**

Buckle **MUST** face out.

You **MUST** use the 1st or 2nd buckle slots when child restraint is used rear facing.

Any slot can be used when forward facing.

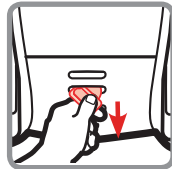

**2. Pull Metal Retainer Completely Through Pad and Shell**



**3. Check Buckle**

Pull up on buckle to make sure it is secured.

The buckle **MUST** not pull out.

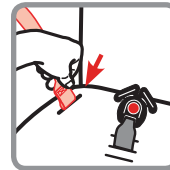

**4. Rethread Harness Strap**

With sewn end of harness strap loop facing the buckle, thread harness strap down through hip harness slot.

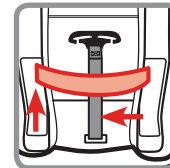

**5. Pull Harness Strap Across Bottom of Shell**

Harness strap **MUST** lie in front of harness adjustment strap as shown. Push harness strap up through other hip harness slot.

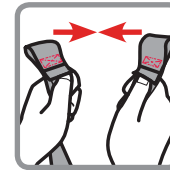

**6. Make Harness Strap Even**

Sewn ends of harness strap loops **MUST** face each other.

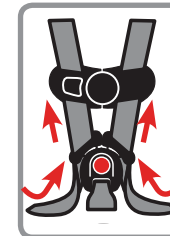

**7. Thread Buckle and Chest Clip**

Harness strap ends go through the **back** of buckle tongues and through the chest clip **front to back** as shown.

*continued on next page*

## Accessories on Select Models

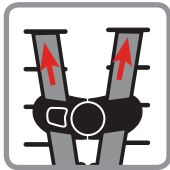

**8. Thread Harness Strap Into Correct Shoulder Harness Slots For Your Child**  
See pages 4-5 for fit guidelines.

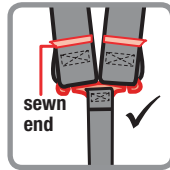

**DO NOT** twist harness strap or harness adjustment strap. Make sure the harness strap loops are fitted **COMPLETELY ON** both sides of the splitter plate.



**9. Attach Harness Strap Loops to Splitter Plate**  
Sewn ends of the harness strap loops **MUST** face towards you.

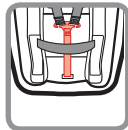

**⚠ WARNINGS:** Failure to place harness adjustment strap behind the harness strap as shown can result in serious injury or death. Harness system must be installed correctly. Failure to follow these warnings can result in serious injury or death.

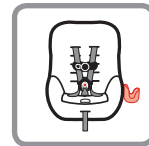

### Cup Holder

The cup holder can be attached to either side of the shell.

Pull pad off corner of shell. Align symbol on cup holder with symbol on shell.

Hook bottom of cup holder under edge of shell. Snap top of cup holder over edge of shell.

Replace pad.

The cupholder is dishwasher safe.



## Child Restraint Use

Do not use a child restraint that has been in a crash or a collision. The system must be replaced. Do not use a child restraint if you do not know the history of the restraint. Never take your child out of the child restraint or attend to the child's needs while the vehicle is moving. Never leave child unattended in the child restraint. To avoid the child being seriously burned, always check for hot seat and buckles before using this child restraint. Do not use a child restraint with missing or damaged parts. Do not lubricate the buckles, harness system, or fasteners for any reason. DJG does not recommend the use of accessories or add-ons that have not been certified with this child restraint at

original purchase date. Never allow any child to play with this child restraint. It is not a toy. Do not remove the warning labels. This child restraint has been certified for use in passenger vehicles and aircraft. Do not use in a boat, on a motorcycle or in a cargo van or bus where there are no seat belts or tether anchors. Do not modify for use as a crib or a swing. Do not leave on stove top or any other hot surface. On the side of the child restraint there is a date of manufacture label. Do not use this child restraint more than 8 years after the date of manufacture. Read all instructions and warning labels for additional warnings.

## Installation in Vehicle

Check the vehicle belt or UAS belt before each use. Use only if the belt is tightened properly and securely. When unoccupied the rear-facing child restraint must be firmly secured to the vehicle with a lower universal anchorage system if available or with a vehicle seat belt. The tether strap must be stored as described in the instruction manual. When unoccupied, the forward-facing child restraint must be firmly secured to the vehicle with a lower universal anchorage system if available or with a vehicle seat belt and the tether strap. In a crash or sudden stop, an unsecured child restraint could injure the driver or other occupants in the vehicle.



Always check vehicle owner's manual for proper use of vehicle seat belts and the Universal Anchorage System (UAS) with your child restraint. In very few vehicles, the child restraint cannot be properly installed because of the type of seat belt system, airbag system and/or lack of location to anchor the tether strap. Always read and follow the vehicle owner's manual instructions for child restraint use.





## Vehicle Seating Position



Never install a rear-facing child restraint in the front seat of a vehicle equipped with an active passenger side frontal airbag.

Always check vehicle owner's manual for child restraint use with side airbags.



For vehicles with no rear seats, check the vehicle owner's manual for location and installation of a child restraint.



Use the child restraint only on vehicle seats that face forward.

Do not use on seats that face the sides or rear of the vehicle.

For vehicles with an airbag, but without a back seat, refer to your vehicle owner's manual.



If you are not sure where to place the child restraint in your vehicle,

consult your vehicle owner's manual or contact Dorel Juvenile Group Consumer Care Department.

**Children are safer when properly restrained in rear seating positions than in the front seating positions.**

According to accident statistics, children in rear seating positions are statistically safer, whether you have airbags, advanced airbags, or no airbags at all.

## Transport Canada Regulations



**To avoid your child being seriously burned, take the following precautions:**

1. Park in the shade or where sun does not directly hit the child restraint.
2. Cover the child restraint with a sheet or blanket when not in use.
3. Check for hot seat and buckles before placing child in child restraint.

To help protect your vehicle seat's upholstery from damage, use a single layered towel underneath and behind child restraint.

Transport Canada Road Safety Directorate regulates children's restraint systems under the Motor Vehicle Restraint Systems Safety Regulations (RSSR).

The regulations require the manufacturer and/or importer to certify the child restraint to the applicable safety standards and place specified warnings and information on the labels fastened to each child restraint and in this instruction manual.



## Choosing UAS or Vehicle Belts

Your vehicle's features may be considerably different than those pictured here.

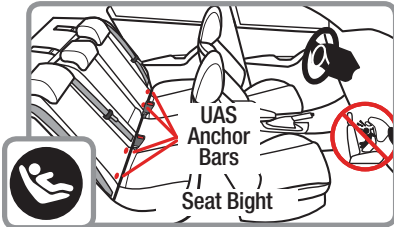

### The UAS

The Universal Anchorage System (UAS) is a universal system for installing child restraints without using vehicle seat belts. The UAS system can ONLY be used in vehicles that have the UAS anchor bars installed and designated UAS seating positions. Most vehicles manufactured after September 2002 are equipped with UAS.

Check your vehicle owner's manual to see which seating positions may be equipped with the UAS system. **When installing this child restraint with vehicle belts, the UAS hooks and belt MUST be properly stored.**

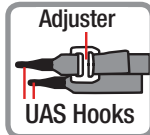

### To store UAS belt on this child restraint:

**When used rear facing**, thread UAS belt through forward-facing belt path. Then attach hooks to attachments near rear-facing belt path as shown. Gently pull free end of belt to remove slack.



**When used forward facing**, thread UAS belt through rear-facing belt path. Then attach hooks to attachments near rear-facing belt path as shown. Gently pull free end of belt to remove slack.

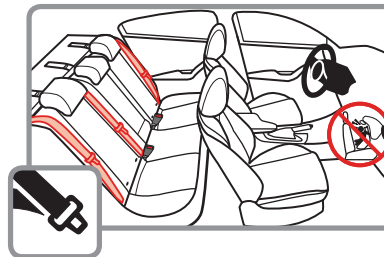

### Vehicle Belts

If UAS is not an option, you must use the vehicle seat belt system to install the child restraint.

There are some vehicle belts that will not work with a child restraint or will require special attention. Check your vehicle owner's manual for specific instructions.

**⚠ WARNINGS:** When used correctly the UAS belt or vehicle belts are equally safe. Do not use both the UAS belt and vehicle belt at the same time.



## Knowing Your Vehicle Belts

Not all vehicle belts and seating positions will work with child restraints. Please follow the following steps to understand how to lock a child restraint with a vehicle belt.



### 1. You MUST Review Your Vehicle Owner's Manual

Your vehicle owner's manual will let you know what vehicle

belts and seating positions child restraints can be installed in.



### 2. Determine How the Child Restraint Will Be Locked Into Place

The vehicle belt MUST NOT loosen after tightening.

This means there needs to be a way to lock the vehicle belt.

The ways this can be done are:

- By using the seat belt's retractor; or
- By using the seat belt's latch plate.

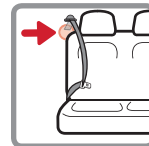

### 3. Check the Retractor

Retractors pull seat belts into stored positions and lock the belt to hold passengers in place.

A retractor is most likely how you will be locking a child restraint into place.

See the following "Types of Retractors" section for some common types of vehicle belt retractors that will work with this child restraint.

## Types of Retractors

**Switchable Retractor**  
(most vehicles have this type)



This retractor can be switched to a locking mode. You **MUST** have the retractor in the locking mode to use the seat belt with this child restraint.

**Switching to locking mode:** Slowly pull the shoulder belt all the way out, then let it go back in an inch or two.

As it goes back in, you will most likely hear a ratcheting sound.

Gently pull the belt to see if it has locked. You will not be able to pull any more belt out if the lock has engaged.

*continued on next page* **32**

**Automatic Locking Retractor**



This retractor always locks.

It will automatically lock after slowly pulling the seat belt out at least halfway and letting the belt go back into the retractor an inch or two.

**Emergency Locking Retractor**

See Step 4  
"Check the Latch Plates"

If the retractor does not lock, it is most likely an Emergency Locking Retractor. These retractors only lock during a sudden stop or collision.



**4. Check the Latch Plates**

Latch plates are the part of the seat belt that goes into the buckle.

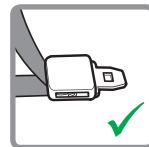

**Locking Latch Plate**

Hold the lap belt with one hand and with your other hand grasp the tongue of the latch plate (the part that goes inside the buckle). Pull the latch plate straight out in line with the lap belt.

You will need to determine if your seat belt's latch plate can lock the belt. See Step 4, "Check the Latch Plates."

If the latch plate does not slide up and down the vehicle belt, it is a **locking latch plate**.



**Emergency Locking Retractor with a Sliding Latch Plate**

If the latch plate slides up and down the vehicle belt, it is a **sliding latch plate**.

Sliding latch plates easily slip between the lap and shoulder portions of the belt.

If you have an Emergency Locking Retractor with a Sliding Latch Plate, you **MUST** use a locking clip to install the child restraint. See pages 55-56.

**Never Use With This Child Restraint**

Emergency Locking Retractor Lap Only Belt



Inflatable Seat Belts





## Aircraft Information

This restraint is certified for aircraft use.

Install the child restraint in a window seat to avoid blocking the aisle. If the aircraft lap belt is too short, ask the flight attendant for a belt extender.

Use only on forward facing aircraft seats.

Contact the airline for their specific policies.



Some airlines may ask to see a label stating that this child restraint is certified for aircraft use.

There is an airplane certification label located on the side of this child restraint as shown.

**WARNING:** Store UAS belts and tether strap when using the aircraft belts.



### Rear Facing Aircraft Installation

For rear facing installation follow pages 42-45.



### Forward Facing Aircraft Installation

For forward facing installation follow pages 52-54.

## Rear Facing



2.3-18 kg (5-40 lb)  
48-102 cm (19-40 in.)

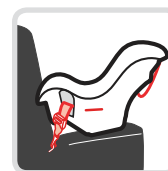

UAS Belt



Lap Belt

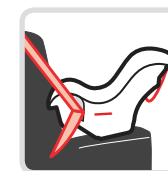

Lap/Shoulder Belt



**WARNINGS:** Never install a rear facing child restraint in the front seat of a vehicle equipped with an active frontal airbag.

This child restraint **MUST** always face the rear of the vehicle until the child is at least 1 year old and weighs 10 kg (22 lb).

The American Academy of Pediatrics recommends that children remain rear facing until they are at least 2 years old. Please talk to your doctor about the best option for your child.



## UAS Belt Installation

**⚠ WARNINGS:** Do not use the UAS belt along with the vehicle lap or lap/shoulder belt.

Check UAS belt before each use. Use only if the belt can be tightened properly and securely.

Do not fasten multiple UAS hooks on the same UAS anchor bar in the vehicle.

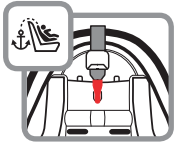

Store the tether hook when used rear facing. Attach the tether hook to storage attachment as shown and gently

tighten to remove slack.

Failure to follow these warnings can result in serious injury or death.

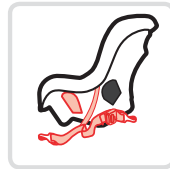

### 1. Remove UAS Belt from Storage Location

Remove it from the rear-facing belt path so both hooks are on the same side of the seat as shown.



### 2. Route UAS Belt Through Rear-Facing Belt Path

The UAS belt adjuster can be on either side.

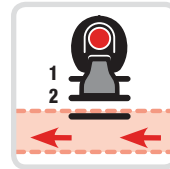

### 3. Reach Under Pad and Pull Hook Across to Opposite Side

Belt **MUST** be in front of buckle strap and under pad.

You **MUST** use the 1st or 2nd buckle slot.

Do not twist belt.

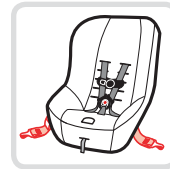

### 4. Finished UAS Belt Routing



### 5. Place Child Restraint Rear Facing in Back Seat

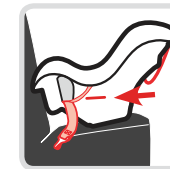

**6. Check Level Line**  
For children who cannot sit up unassisted, the level line on shell **MUST** be parallel with the ground.

For children who can sit up unassisted, you may rotate the child restraint to be more upright.



### 7. Attach UAS Hooks to Vehicle's UAS Anchors

Review your vehicle owner's manual for UAS anchor locations and UAS belt use.



### 8. Tighten Belt

Place hand in child restraint.

Firmly push child restraint down and back towards the vehicle seat back while pulling free end of belt to tighten.



It may be easier to pull pad away from shell and pull the free end of the belt parallel with the belt path through belt path opening as shown.

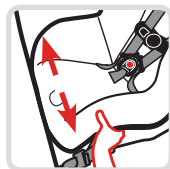

### 9. Check Belt Tightness

Hold child restraint at the belt path with your weakest hand.

Push and pull from side to side. It should not move more than 2.5 cm (1 in.).

**If it moves more than 2.5 cm (1 in.), you can try:**

- A. Pulling the belt tighter.
- B. Reinstalling the child restraint.
- C. Changing to a different seating location.
- D. Switching to vehicle belt installation.



### 10. Secure Child in Child Restraint

See pages 15-17.



**11. Recheck Level Line**

Repeat steps 6-10 if level line is not parallel with the ground.

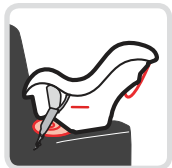

**NOTE:** You may need to place a large rolled towel(s) or foam pool noodle(s) under front of child restraint to help make level line parallel with the ground.

Check often to be sure padding is still in place and the belt is tight.

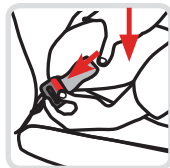

**To Release UAS Belt**

**Remove child from child restraint.**

Remove tension from the UAS belt by pushing down on side of child restraint with the UAS belt adjuster. Then press the adjuster button to loosen belt. Unhook

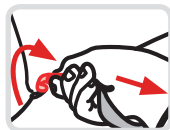

from anchor by squeezing spring lever on hook, pushing hook back into the seat bight, and twisting. Then pull it out of the vehicle seat.

**Store UAS belt when not in use. See page 29.**

**Vehicle Belt Installation**



**⚠ WARNINGS:** Do not use the UAS belt along with the vehicle lap or lap/shoulder belt.

Secure UAS hooks to storage attachments as shown when installing with vehicle belts.



Store the tether hook when used rear facing. Attach the tether hook to storage attachment as shown and gently tighten to remove slack.

Check vehicle belt before each use. Use only if the belt can be tightened properly and locked securely in place.

**Failure to follow these warnings can result in serious injury or death.**





**1. Place Child Restraint Rear Facing in Back Seat**



**2. Check Level Line**

For children who cannot sit up unassisted, the level line on shell **MUST** be parallel with the ground.

For children who can sit up unassisted, you may rotate the child restraint to be more upright.



**3. Check if Your Vehicle Belts Will Work With This Child Restraint**

This is very important because **not all vehicle belts will**

**work with child restraints.**

Review pages 31-34 and your vehicle owner's manual to determine what kind of vehicle belt you have and how to lock a child restraint in place.

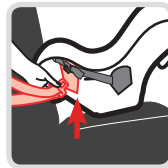

**4. Route Vehicle Lap or Lap/Shoulder Belt Through Rear-Facing Belt Path**

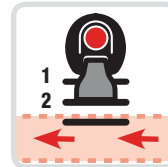

**5. Reach Under Pad and Pull Vehicle Belt Across the Shell**

Belt **MUST** be in front of the buckle strap and under pad.

You **MUST** use the 1st or 2nd buckle slot. **Do not twist belt.**

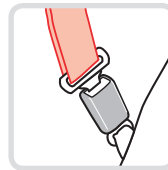

**6. Buckle Vehicle Belt**

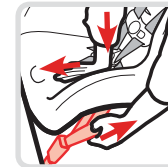

**7. Tighten Belt**

Place hand in child restraint.

Firmly push child restraint down and back towards the

vehicle seat back while pulling shoulder belt or the free end of lap belt to tighten.

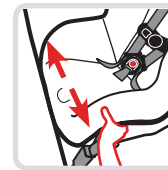

**8. Check Belt Tightness**

Hold child restraint at the belt path with your weakest hand.

Push and pull from side to side. It should not move more than 2.5 cm (1 in.).

*continued on next page* **44**

If it moves more than 2.5 cm (1 in.), you can try:

- A. Pulling the belt tighter.
- B. Reinstalling the child restraint.
- C. Changing to a different seating location.
- D. Switching to the UAS belt installation if UAS anchors are available in your vehicle.

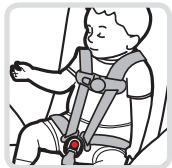

### 9. Secure Child in Child Restraint

See pages 15-17.



### 10. Recheck Level Line

Repeat steps 2-9 if level line is not parallel with the ground.



**NOTE:** You may need to place a large rolled towel(s) or foam pool noodle(s) under front of child restraint to help achieve the correct recline angle. Check often to be sure padding is still in place and the belt is tight.

## Forward Facing



10-18 kg (22-40 lb)  
74-110 cm (29-43 in.)  
and at least 1 year old



UAS Belt with Tether



Lap Belt with Tether



Lap/Shoulder Belt with Tether



**⚠ WARNINGS:** In this child restraint your child **MUST** be at least 1 year old and weigh 10 kg (22 lb) before they sit forward facing.

The American Academy of Pediatrics recommends that children remain rear facing until they are at least 2 years old and remain in a five-point harness until they outgrow their forward-facing harnessed child restraint. Please talk to your doctor about the best option for your child.



## Tether Use

**⚠ WARNING:** Tether straps are required in Canada. Using this child restraint without the tether strap anchored as recommended by the manufacturer would be a misuse of the child restraint and, in a sudden stop or crash, could cause serious injury or death. Do not fasten multiple tether hooks on the same tether anchor in the vehicle.

You **MUST** always attach, adjust, and secure the top anchorage (tether) strap when installing the child restraint forward facing with internal harness. Tethers improve the installation and stability of child restraints and reduce the risk of injury. Attach the tether hook to the tether anchor designated by your vehicle manufacturer for that seating

position. Check your vehicle owner's manual for more information. If the seating position does not have a tether anchor, use a different seating position or see your dealer or a qualified mechanic and have one installed.



### Adjusting Tether Strap

**To tighten:** After the child restraint is locked into place with UAS belt or vehicle belt, push down on child restraint and gently pull on free end of tether.

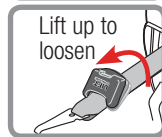

**To loosen:** Lift up on tether lock adjuster and push it towards tether hook.

## UAS Belt Installation



### Storing Tether Strap

When installing rear facing or when seat is not in use, attach the tether hook to its

storage attachment on back of shell as shown.

Gently tighten to remove slack.

**⚠ WARNINGS:** Do not use the UAS belt along with the vehicle lap or lap/shoulder belt.

Check the UAS belt before each use. Use only if the belt can be tightened properly and securely.

Do not fasten multiple UAS hooks on the same UAS anchor bar in the vehicle.

Failure to follow these warnings can result in serious injury or death.



**1. Remove UAS Belt from Storage Location**

Remove it from the rear-facing belt path so both hooks are on the same side of the seat as shown.



**2. Route UAS Belt Through Forward-Facing Belt Path**

**Do not twist belt.**  
The UAS belt adjuster can be on either side.

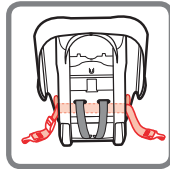

**3. Finished UAS Belt Routing**



**4. Place Child Restraint Forward Facing Flush Against Vehicle Seat Back**



**5. Loosely Attach Tether Hook to Vehicle's Anchor**

Check vehicle owner's manual for specific location.



**6. Attach UAS Hooks to Vehicle's UAS Anchors**

Review your vehicle owner's manual for UAS anchor locations and UAS belt use.

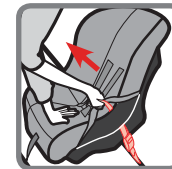

It may be easier to pull pad away from shell and pull the free end of the belt parallel with the belt path through belt path opening as shown.



**7. Tighten Belt**

Place hand in child restraint.  
Firmly push down while pulling free end of belt to tighten.



**8. Tighten Tether**

Push firmly on the back of the seat and pull the tether strap to remove all slack and create tension on the strap.

## Vehicle Belt Installation

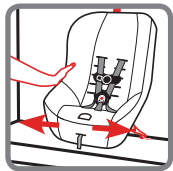

### 9. Check Belt Tightness

Hold child restraint at the belt path with your weakest hand. Push and pull from side to side.

It should not move more than 2.5 cm (1 in.). **If it moves more than 2.5 cm (1 in.), you can try:**

- A. Putting your knee in the seat and pulling the belt tighter.
- B. Reinstalling the child restraint.
- C. Changing to a different seating location.
- D. Switching to vehicle belt installation.



### To Release UAS Belt

Remove child from child restraint.

Remove tension from the UAS belt by pushing down on side of child restraint with the UAS belt adjuster. Then press the adjuster button to loosen belt. Unhook



from anchor by squeezing spring lever on hook, pushing hook back into the seat bight, and twisting. Then pull it out of the vehicle seat.

**Store UAS belt when not in use. See page 30.**

**⚠ WARNINGS:** Do not use the UAS belt along with the vehicle lap or lap/shoulder belt. Secure UAS hooks



to storage attachments as shown when installing with vehicle belts.

Check vehicle belt before each use. Use only if the belt can be tightened properly and locked securely in place.

Failure to follow these warnings can result in serious injury or death.



**1. Place Child Restraint Forward-Facing Flush Against Vehicle Seat Back**

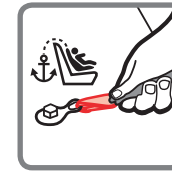

**2. Loosely Attach Tether Hook to Vehicle's Anchor**

Check vehicle owner's manual for specific location.



### 3. Check if Your Vehicle Belts Will Work With This Child Restraint

This is very important because **not**

**all vehicle belts will work with child restraints.**

Review pages 31-34 and your vehicle owner's manual to determine what kind of vehicle belt you have and how to lock a child restraint in place.



### 4. Route Vehicle Lap or Lap/Shoulder Belt Through Forward-Facing Belt Path

Do not twist belt.

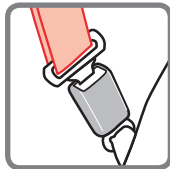

### 5. Buckle Vehicle Belt

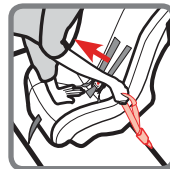

### 6. Tighten Belt

Place hand in child restraint.

Firmly push down while pulling shoulder belt or the free end of lap belt to tighten.



### 7. Tighten Tether

Push firmly on the back of the seat and pull the tether strap to remove all slack and create tension on the strap.



### 8. Check Belt Tightness

Hold child restraint at the belt path with your weakest hand.

Push and pull from

side to side. It should not move more than 2.5 cm (1 in.). **If it moves more than 2.5 cm (1 in.), you can try:**

**A.** Putting your knee in the seat and pulling the belt tighter.

**B.** Reinstalling the child restraint.

**C.** Changing to a different seating location.

**D.** Switching to the UAS belt installation if UAS anchors are available in your vehicle.



## Using a Locking Clip

You will rarely need to use a locking clip except in some older vehicles.

Built-in child restraint locking systems have been required in vehicles since 1996 and many vehicles had these features even earlier. Review pages 31-34 and your vehicle owner's manual to determine if your vehicle belts require a locking clip.

If you need a locking clip immediately, they are likely available at an auto dealership, an auto store, or where you purchased this child restraint. You can also call us at 1-800-544-1108 for one.

A locking clip will not fix all types of seat belt problems. You **MUST** have a lap and shoulder belt to use a locking clip.

**For Rear Facing installation**, follow Pages 42-44 Warnings and Steps 1-7 before starting locking clip installation.

**For Forward Facing installation**, follow Pages 52-54 Warnings and Steps 1-7 before starting locking clip installation.



### 1. Determine Locking Clip Position

Grasp both vehicle belts together just behind the latch plate to mark the position for locking clip. Unbuckle the belt.

**NOTE:** If the latch plate ends up just at the belt path opening so you cannot grasp the vehicle belt at the latch plate, grasp the vehicle belts on the opposite side of the child restraint, as close to the latch plate as possible.

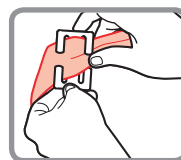

### 2. Attach Locking Clip

Thread both portions of the vehicle belt onto the locking clip, as close to the latch plate as possible.

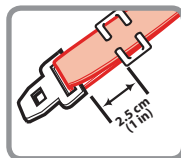

### 3. Position Locking Clip

It should be about 2.5 cm (1 in.) from vehicle belt's latch plate.

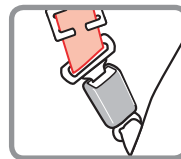

### 4. Rebuckle Vehicle Belt

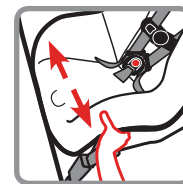

### 5. Check Belt Tightness

Hold child restraint at the belt path with your weakest hand.

Push and pull from side to side. It

should not move more than 2.5 cm (1 in.). **If it moves more than 2.5 cm (1 in.), you can try:** A. Reinstalling the child restraint. B. Changing to a different seating location.

**When installed rear facing**, recheck the level line.

**When installed forward facing**, make sure to tighten the tether strap.

**Remove the locking clip when the seat belt is not being used with a child restraint.**

## Dorel Juvenile Group Information

Thank you for choosing this child restraint. The DJG family is committed to creating child restraints with the most comfort and convenience available today. Remember, parents are a child's first teachers and examples. If you always buckle your seat belt, your child will think it is the natural thing to do. Make it a firm rule that the vehicle does not go until everyone is buckled up. Make no exceptions.

No one can predict if use of a child restraint will prevent injury or death in a particular crash. However, when combined with careful driving, proper use of a child restraint can lower a child's risk of injury or death in most crashes.

Your child's safety is worth the time it will take to read and follow these instructions. After reading, if you still have questions or have any concerns with this child restraint, please contact our Consumer Care Department at:

**Website:** [www.djgusa.com](http://www.djgusa.com)

**Telephone:** 1-800-544-1108

M-TH from 8 A.M. to 6 P.M. EST

FRI from 8 A.M. to 4:30 P.M. EST

### Mailing Address:

Dorel Juvenile Group, Inc.  
Consumer Care Department  
P.O. Box 2609  
Columbus, IN 47202-2609

## Registration and Safety Notices

Although child restraints are tested, evaluated, and certified by the manufacturer and tested by Transport Canada, it is possible that a safety-related problem may be found. If there is ever a safety issue with your child restraint, we use registration information to reach owners.

If you don't have the card or if your address changes, you will find the model number, manufacture date, and line code on the label located on side of shell.

0515079 Tear Off and Mail This Part or Register Online 4349-0081D  
Consumer: Just fill in your name, address and email. Please print (use dark ink).  
Your Name \_\_\_\_\_  
Email Address (optional) \_\_\_\_\_  
Model Number BC098-BVM Line Code COSCO SCENERA NEXT Manufacture Date YYYY/MM/DD

### Example of model number, manufacture date, and line code.



If you don't have the card or if your address changes, you will find the model number, manufacture date, and line code on the label located on side of shell.

*continued on next page* 58



There are three additional ways to register your information:

**Online:** [www.djgusa.com/registration/carseat/can](http://www.djgusa.com/registration/carseat/can)

**Telephone:** 1-800-544-1108

**Mail:** Send your name, address and your child restraint's model number, manufacture date, date of purchase, and line code to:

Dorel Juvenile Canada  
Attn: Consumer Care  
2855 Argentia Road, Unit 4  
Mississauga, ON L5N 8G6

Please do not send in your registration card if you have registered your child restraint online.

For information on safety-related problems, you can also call Transport Canada's Road Safety Dept. at: 1-800-333-0371.

### Replacement Parts Order Form

Complete the form. Your model number and manufacturer date code **MUST** be included on the form to ensure proper replacement parts. The codes can be found on a label on side of child restraint. Payment in U.S. dollars must accompany your order. Choose parts needed from the list on the next page. Return the form with payment to:

**Dorel Juvenile Group, Inc.**  
**Consumer Care Department**  
P.O. Box 2609  
Columbus, IN 47202-2609

Please make money orders payable to Dorel Juvenile Group, Inc. Fill in the area on the next page to charge credit card. (Visa or MasterCard **only**). We do not accept cash, personal checks, or other credit cards. All outside of U.S. and Canada **MUST** use credit card.

#### Ship To: (Please Print)

Name: \_\_\_\_\_

Address: \_\_\_\_\_

City: \_\_\_\_\_

State/Province: \_\_\_\_\_

Postal Code: \_\_\_\_\_

Telephone: \_\_\_\_\_

Email Address: \_\_\_\_\_

We **MUST** have this information:

**Model Number** (8 to 9 characters):

\_\_\_\_\_

**Manufacture Date** (yyyy/mm/dd):

\_\_\_\_\_

**Replacement Parts List**

**NOTE:** If requested color is not available, similar color will be substituted. Prices are subject to change.

Part	Cost	Qty	Total Cost
Buckle Assembly	\$7.99	...	\$ _____
Harness Strap	\$2.99	...	\$ _____
Seat Pad Set	\$24.00	...	\$ _____
Chest Clip	\$1.50	...	\$ _____
Tether	\$6.50	...	\$ _____
UAS Belt	\$17.99	...	\$ _____
Instructions	\$0.00	...	\$ _____
Locking Clip	\$2.50	...	\$ _____

**Merchandise Total:** \$ \_\_\_\_\_

**Shipping and handling:**..... \$ \_\_\_\_\_

Up to \$25.00 .....	\$5.95	\$100.01 to \$150.00..	\$10.95
\$25.01 to \$50.00 .....	\$6.95	\$150.01 to \$200.00..	\$11.95
\$50.01 to \$75.00 .....	\$8.95	\$200.01 and up.....	\$13.95
\$75.01 to \$100.00 .....	\$9.95		

**Sales Tax..... \$ \_\_\_\_\_**  
 Residents of Quebec, add 5% GST and 9.975 PST%.  
 Residents of New Brunswick, Newfoundland and Labrador, add 15% HST.  
 Residents of Nova Scotia add 15% HST.  
 Residents of Saskatchewan add 5% GST and 6% PST.  
 Residents of Manitoba add 5% GST and 8% PST.  
 All other Provinces and Territories, add 5% GST.

**Grand Total..... \$ \_\_\_\_\_**  
 No shipping and handling on instructions for quantities under 6. Add \$.50 for each instruction over 6, then add applicable shipping and handling.

**Fill Out For Credit Card**  
 Visa  MasterCard

**Card Exp. Date:** \_\_\_\_\_

**Cardholder's Name:** \_\_\_\_\_

**Card Number:** \_\_\_\_\_

**Signature:** \_\_\_\_\_

CUT ON DOTTED LINE

**Warranty**

Dorel Juvenile Group, Inc. (DJG) warrants this product to the original retail purchaser as follows:

This product is warranted against defective materials or workmanship for one year from the date of original purchase. **An original receipt is required to validate your warranty.** DJG will, at its option, provide replacement parts or replace this product. DJG reserves the right to substitute if the part or model has been discontinued.

To make a claim under this warranty write to DJG, Consumer Care Department, P. O. Box 2609, Columbus, IN 47202-2609; or call 1-800-544-1108 from 8:00 a.m. to 6:00 p.m. EST

Monday through Thursday and from 8:00 a.m. to 4:30 p.m. on Friday.

**Proof of purchase is required and shipping charges are the responsibility of the consumer.**

**Warranty Limitations:** This warranty does not include damages which arise from misuse or abuse of this product.

**Limitation of Damages:** The warranty and remedies as set forth are exclusive and in lieu of all others, oral or written, expressed or implied. In no event will DJG or the dealer selling this product be liable to you for any damages, including incidental or consequential damages, arising out of the use or inability to use this product.