









## Assembly Instructions, #11605 Narrow Chairside Table

### Parts List

Item	Parts	Description	Quantity
A		Top Assembly	1
B		Legs	4
C		Shelf	1

### Hardware List

Item	Hardware	Description	Quantity
1		Allen Bolts	8
2		Flat Washers	8
3		Lock Washers	8
4		Allen Wrench	1
5		Shelf supports	4

## Assembly Steps

### Step 1

- 1.1 Lay the Top Assembly (A) upside-down on a soft surface.
- 1.2 Fasten the legs with (8) bolts, flat washers and lock washers using the Allen wrench. Do not tighten, leave enough clearance to allow for placing the shelf.

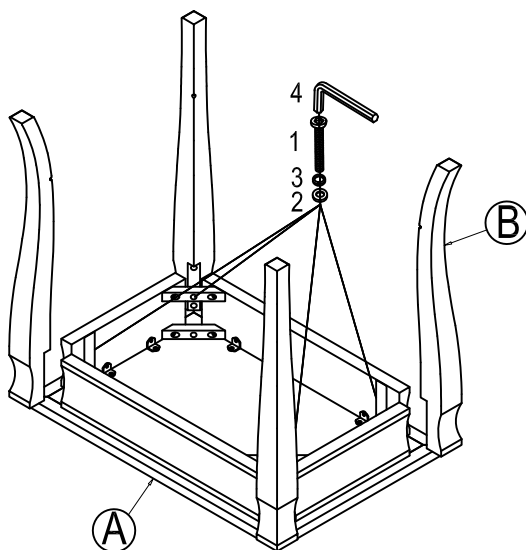

### Step 2

- 2.1 Position the assembled piece upright.
- 2.2 Insert all shelf supports to the holes on legs. Tilt the shelf slightly and insert one end between legs above the shelf supports first, then bring the other end up to have it rest evenly on 4 shelf supports.
- 2.3 Check to ensure all joints are properly aligned. Push the legs moderately inward while tightening all the bolts.

