

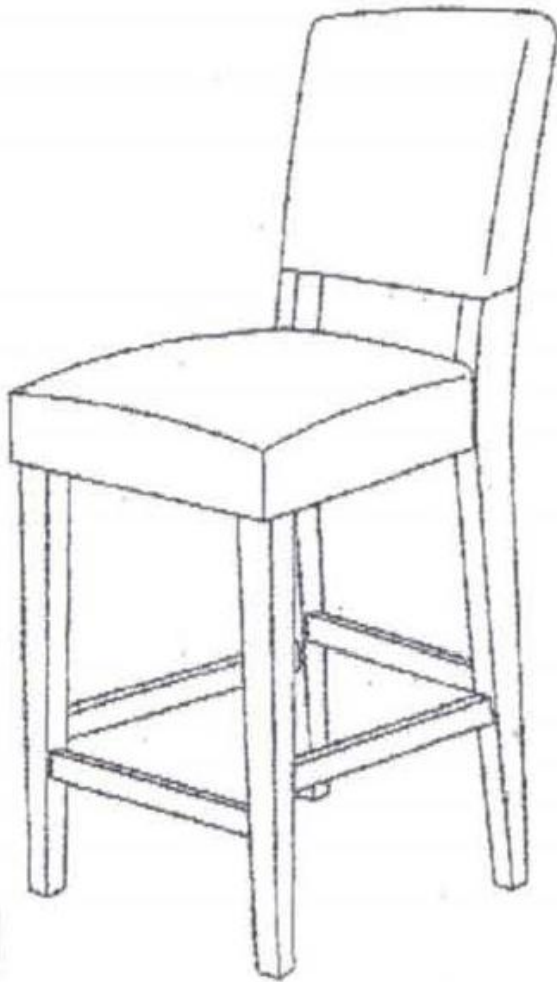

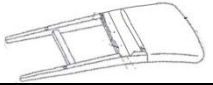

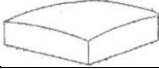





Assembly Instructions, #10086

Upholstered Back 24" Counter Height Stool

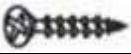

A: Chair Back	
B: Seat Pad	
C: (2) Side Stretchers L & R	
D: Front Stretcher	
E: (2) Front Legs	
G: Bolt 1/4 " *1-3/4 "	
H: (4) Bolts 1/4 " *2-1/4 "	
I: (4) Bolts 1/4 " *3-1/4 "	
J: (9) Lock Washers	
K: (9) Flat Washers	
L: (6) Screws 8*1-3/4 "	
M: Allen Wrench	

Step 1

Fasten the seat frame onto chair back. Do not tighten.

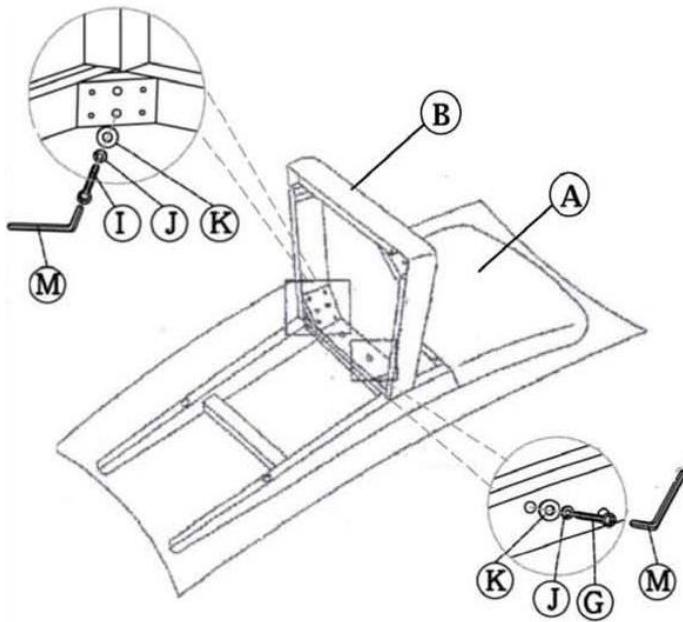

Step 2

Place the chair assembly upside down on a table. Insert two side stretchers into back leg holes. Make sure the "L" and "R" stickers on the bottom of stretcher should be connected to back legs. Also, make sure the front leg sticker matches the sticker on the seat frame before attaching two front legs. Tighten bolts when all stretchers in place and all legs are properly leveled.

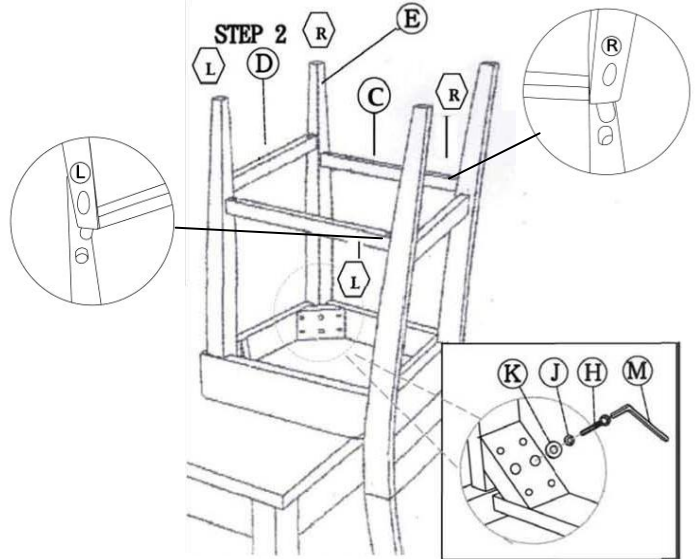

Step 3

Fasten the stretchers and legs with screws.

