



THE PURSUIT OF BEAUTY AND
FUNCTIONALITY.

Fine decorative hardware for the kitchen and bath.
Discover the style, the quality, the craftsmanship that
makes Top Knobs the brand of choice for designers...
and those captivated by design.



Top Knobs
170 Township Line Road
Hillsborough, New Jersey 08844



INSPIRING BEAUTY

Over 3000 products. 30 finishes. Endless possibilities.

Table of Contents

Sanctuary 4	Stainless Steel 14	Asbury 16	Aspen 20
Bar Pulls 28	Britannia 32	Chateau 36	
Crystal 42	Dakota 44	Edwardian 48	Normandy 52
Nouveau 58	Oil Rubbed Bronze 68	Somerset 70	
Tuscany 76	Appliance 80	Bath 94	Displays & Finishes 104

From Ordinary to Extraordinary. 7 Solid Reasons Why.

It's all in the details – the right decorative hardware just makes the look. More than an accessory, the hardware is the jewel that draws the eye, accentuates the style and adds elegance to the space it graces. But true beauty goes beyond initial good looks. It's in the style, the depth of the finish and in the weighty feel of the piece in your hand.

It Starts with the Finish.

Top Knobs' commitment to superior finishes begins with high-grade metals, molds and lacquer. Each hue richly and beautifully crafted - for a difference you can clearly see.

To Have and to Hold.

Smooth to the touch. Every edge, corner and detail individually inspected, hand polished and made to fit your hand. It just feels right.

Solid Construction.

The weighted feel and character of each creation tells you no corners were cut, no backs hollowed. Every piece as it should be... as exceptional as your space.

Lasting Protection.

Our completely sealed finish won't show wear, especially on the knobs and pulls used most.

Guaranteed for Life.

Your hardware will last for years. And we back it with a lifetime warranty for the original purchaser.

Samples are Free!

Express yourself – freely! Get a free sample of any knob and of any pull (less than 7" cc), of any price, for just a \$5 packaging and shipping charge each.

Unmatched Selection.

Choose from the world's most complete compilation of designer-inspired cabinet hardware - with over 3,000 designs, 25 collections and 30 finishes. The only thing missing is you.



From the Start

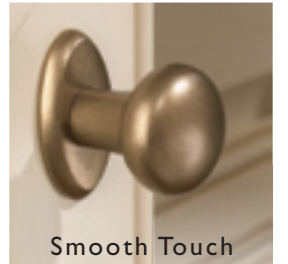

Smooth Touch

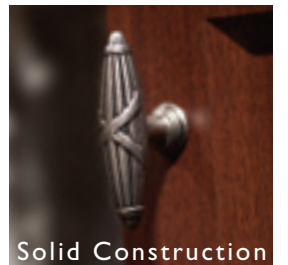

Solid Construction



Sealed Finish



Lifetime Guarantee

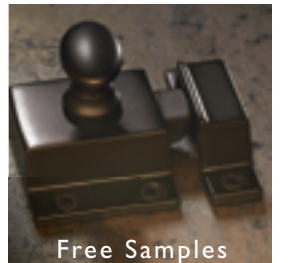

Free Samples

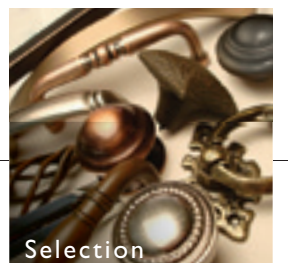

Selection



WWW.TOPKNOBS.COM
800-499-9095
908-359-6174



ALWAYS THE PERFECT OPENING



INSPIRED BY ASIAN ARCHITECTURAL DETAILS,
THE SANCTUARY COLLECTION DELIVERS A SIMPLIFIED,
SOPHISTICATED WAY TO ENHANCE YOUR MODERN
DÉCOR. INSPIRATIONAL AND SIMPLY IRRESISTIBLE...
ORDER YOUR FREE SAMPLE TODAY.

TK86TB on page 10

NEW Sanctuary™ Collection

PULLS & KNOBS ~ 5 STYLES Matching Appliance Pulls - see page 83



Neo Knob/Pull
4" L each



FINISHES
AVAILABLE



6" cc



Pulls and knobs shown in Tuscan Bronze

3" cc



CENTER KNOB

3" cc



THUMB KNOB



CURVED TIDAL PULL



Curved Tidal Pull shown in Pewter Antique

Finish	12" cc	Neo Knob 4" L each	6" cc	3" cc Pull	3" cc Center Knob	3/4" w Thumb Knob	4" cc Curved Tidal Pull
TB	TK46TB	TK42TB	TK45TB	TK44TB	TK43TB	TK52TB	TK41TB
PTA	TK46PTA	TK42PTA	TK45PTA	TK44PTA	TK43PTA	TK52PTA	TK41PTA
PN	TK46PN	TK42PN	TK45PN	TK44PN	TK43PN	TK52PN	TK41PN
PC	TK46PC	TK42PC	TK45PC	TK44PC	TK43PC	TK52PC	TK41PC
ORB	TK46ORB	TK42ORB	TK45ORB	TK44ORB	TK43ORB	TK52ORB	TK41ORB
GBZ	TK46GBZ	TK42GBZ	TK45GBZ	TK44GBZ	TK43GBZ	TK52GBZ	TK41GBZ
BSN	TK46BSN	TK42BSN	TK45BSN	TK44BSN	TK43BSN	TK52BSN	TK41BSN
BLK	TK46BLK	TK42BLK	TK45BLK	TK44BLK	TK43BLK	TK52BLK	TK41BLK



WWW.TOPKNOBS.COM
800-499-9095
908-359-6174

Part Number is specific to shape and finish. cc = measurement center-to-center between the screw holes.

Lifetime Warranty for the original purchaser against defects in materials and craftsmanship.

Free Samples of any knob and of any pull less than 7", with a \$5 packaging and shipping charge each.

NOTE: For detailed dimensions such as overall length, height, base width, etc. see price list or visit TopKnobs.com.



TK61BLK - 1 3/8" L Oval Knob shown in Flat Black

OVAL KNOBS ~ 3 SIZES



1" L Small
Pewter
Antique

1 1/8" L Medium
German Bronze

1 3/8" L Large
Tuscan Bronze

	TB	PTA	PN	PC	ORB	GBZ	BSN	BLK
Small	TK57TB	TK57PTA	TK57PN	TK57PC	TK57ORB	TK57GBZ	TK57BSN	TK57BLK
Medium	TK59TB	TK59PTA	TK59PN	TK59PC	TK59ORB	TK59GBZ	TK59BSN	TK59BLK
Large	TK61TB	TK61PTA	TK61PN	TK61PC	TK61ORB	TK61GBZ	TK61BSN	TK61BLK



TK61ORB & TK62ORB - 1 3/8" L Oval Knob & 1 3/4" L Oval Backplate in Oil Rubbed Bronze

OVAL BACKPLATES ~ 3 SIZES

For the Oval Knobs above and for the Oval Thin Pulls



1 1/4" L Small
Polished Nickel

1 1/2" L Medium
German Bronze

1 3/4" L Large
Tuscan Bronze

	TB	PTA	PN	PC	ORB	GBZ	BSN	BLK
Small	TK58TB	TK58PTA	TK58PN	TK58PC	TK58ORB	TK58GBZ	TK58BSN	TK58BLK
Medium	TK60TB	TK60PTA	TK60PN	TK60PC	TK60ORB	TK60GBZ	TK60BSN	TK60BLK
Large	TK62TB	TK62PTA	TK62PN	TK62PC	TK62ORB	TK62GBZ	TK62BSN	TK62BLK

OVAL SLOT KNOBS ~ 3 SIZES



3/4" cc
Pewter Antique

1 1/2" cc
Oil Rubbed Bronze

5" cc
Polished Chrome

	TB	PTA	PN	PC	ORB	GBZ	BSN	BLK
3/4" cc	TK73TB	TK73PTA	TK73PN	TK73PC	TK73ORB	TK73GBZ	TK73BSN	TK73BLK
1 1/2" cc	TK74TB	TK74PTA	TK74PN	TK74PC	TK74ORB	TK74GBZ	TK74BSN	TK74BLK
5" cc	TK75TB	TK75PTA	TK75PN	TK75PC	TK75ORB	TK75GBZ	TK75BSN	TK75BLK

OVAL THIN PULLS ~ 4 SIZES Matching Appliance Pulls - see page 83



12" cc



7" cc



5" cc



3 3/4" cc



TK67BSN & TK62BSN - 12" cc Oval Thin Appliance Pull and 1 3/4" L Oval Backplate in Brushed Satin Nickel

Pulls shown in Brushed Satin Nickel

	TB	PTA	PN	PC	ORB	GBZ	BSN	BLK
12" cc	TK66TB	TK66PTA	TK66PN	TK66PC	TK66ORB	TK66GBZ	TK66BSN	TK66BLK
7" cc	TK65TB	TK65PTA	TK65PN	TK65PC	TK65ORB	TK65GBZ	TK65BSN	TK65BLK
5" cc	TK64TB	TK64PTA	TK64PN	TK64PC	TK64ORB	TK64GBZ	TK64BSN	TK64BLK
3 3/4" cc	TK63TB	TK63PTA	TK63PN	TK63PC	TK63ORB	TK63GBZ	TK63BSN	TK63BLK

FINISHES AVAILABLE



TB
Tuscan
Bronze

PTA
Pewter
Antique

PN
Polished
Nickel

PC
Polished
Chrome

ORB
Oil Rubbed
Bronze

GBZ
German
Bronze

BSN
Brushed
Satin Nickel

BLK
Flat Black



NOTE: For detailed dimensions such as overall length, height, base width, etc. see price list or visit TopKnobs.com.

Part Number is specific to shape and finish. cc = measurement center-to-center between the screw holes. **Lifetime Warranty** for the original purchaser against defects in materials and craftsmanship. **Free Samples** of any knob and of any pull less than 7", with a \$5 packaging and shipping charge each.

TAPERED KNOBS ~ 3 SIZES



	TB	PTA	PN	PC	ORB	GBZ	BSN	BLK
3/4" w	TK31TB	TK31PTA	TK31PN	TK31PC	TK31ORB	TK31GBZ	TK31BSN	TK31BLK
1" w	TK32TB	TK32PTA	TK32PN	TK32PC	TK32ORB	TK32GBZ	TK32BSN	TK32BLK
1" cc Knob	TK13TB	TK13PTA	TK13PN	TK13PC	TK13ORB	TK13GBZ	TK13BSN	TK13BLK

SQUARE BACKPLATES ~ 2 SIZES

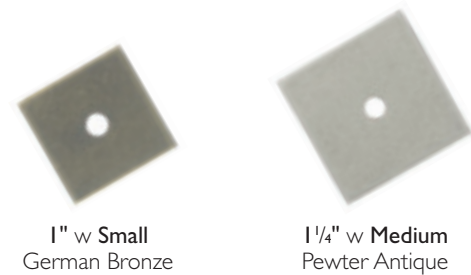

	TB	PTA	PN	PC	ORB	GBZ	BSN	BLK
Small	TK94TB	TK94PTA	TK94PN	TK94PC	TK94ORB	TK94GBZ	TK94BSN	TK94BLK
Medium	TK95TB	TK95PTA	TK95PN	TK95PC	TK95ORB	TK95GBZ	TK95BSN	TK95BLK
Linear Knob	TK33TB	TK33PTA	TK33PN	TK33PC	TK33ORB	TK33GBZ	TK33BSN	TK33BLK

LINEAR KNOB



FINISHES AVAILABLE

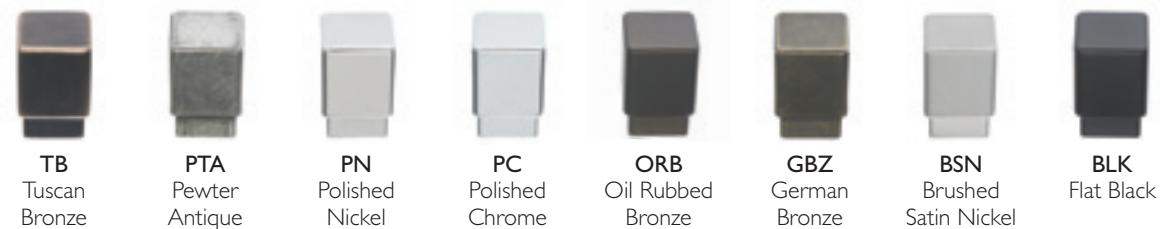

TAPERED BAR PULLS ~ 3 SIZES



Pulls shown in Polished Nickel

	TB	PTA	PN	PC	ORB	GBZ	BSN	BLK
12" cc	TK16TB	TK16PTA	TK16PN	TK16PC	TK16ORB	TK16GBZ	TK16BSN	TK16BLK
7" cc	TK15TB	TK15PTA	TK15PN	TK15PC	TK15ORB	TK15GBZ	TK15BSN	TK15BLK
5" cc	TK14TB	TK14PTA	TK14PN	TK14PC	TK14ORB	TK14GBZ	TK14BSN	TK14BLK

LINEAR CABINET PULLS ~ 3 SIZES

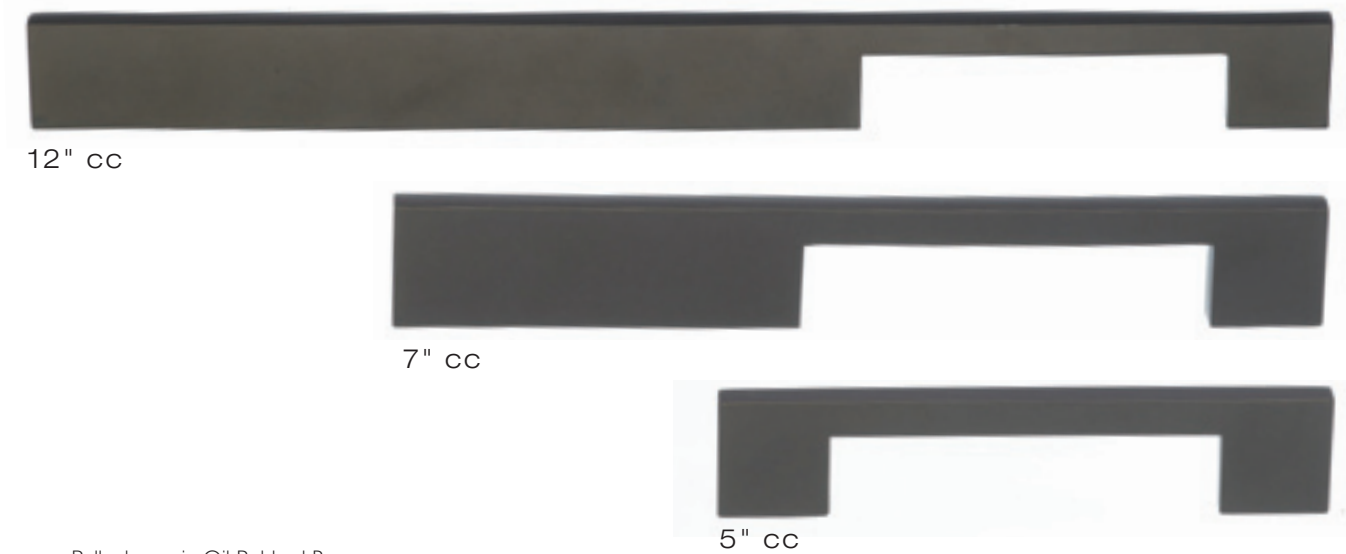

Pulls shown in Oil Rubbed Bronze

	TB	PTA	PN	PC	ORB	GBZ	BSN	BLK
12" cc	TK25TB	TK25PTA	TK25PN	TK25PC	TK25ORB	TK25GBZ	TK25BSN	TK25BLK
7" cc	TK24TB	TK24PTA	TK24PN	TK24PC	TK24ORB	TK24GBZ	TK24BSN	TK24BLK
5" cc	TK23TB	TK23PTA	TK23PN	TK23PC	TK23ORB	TK23GBZ	TK23BSN	TK23BLK



NOTE: For detailed dimensions such as overall length, height, base width, etc. see price list or visit TopKnobs.com.

Part Number is specific to shape and finish. cc = measurement center-to-center between the screw holes. Lifetime Warranty for the original purchaser against defects in materials and craftsmanship. Free Samples of any knob and of any pull less than 7", with a \$5 packaging and shipping charge each.

INSET RAIL KNOB & PULL ~ 2 STYLES

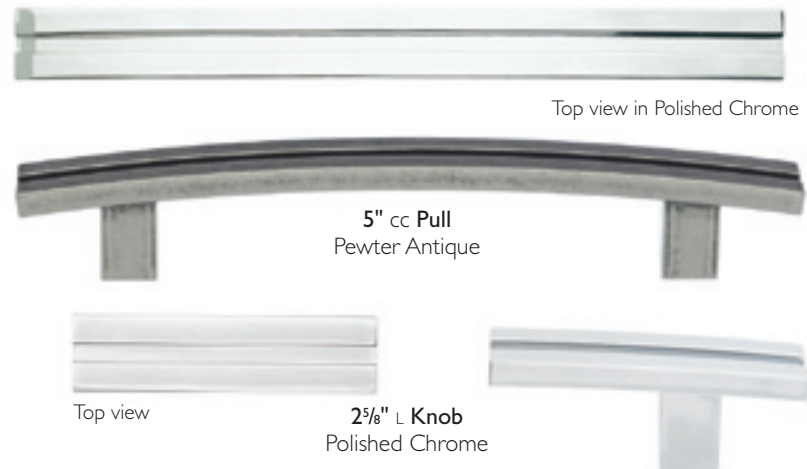

	TB	PTA	PN	PC	ORB	GBZ	BSN	BLK
5" cc Pull	TK81TB	TK81PTA	TK81PN	TK81PC	TK81ORB	TK81GBZ	TK81BSN	TK81BLK
2 5/8" L Knob	TK82TB	TK82PTA	TK82PN	TK82PC	TK82ORB	TK82GBZ	TK82BSN	TK82BLK

FLARED KNOB & PULL ~ 2 SIZES

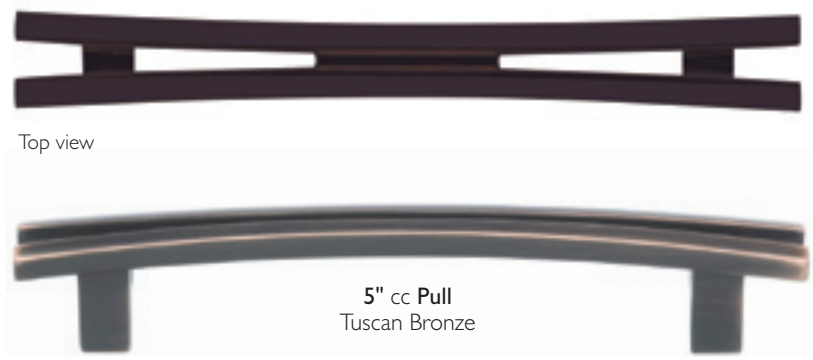

	TB	PTA	PN	PC	ORB	GBZ	BSN	BLK
2 5/8" L Knob	TK87TB	TK87PTA	TK87PN	TK87PC	TK87ORB	TK87GBZ	TK87BSN	TK87BLK
5" cc Pull	TK86TB	TK86PTA	TK86PN	TK86PC	TK86ORB	TK86GBZ	TK86BSN	TK86BLK

FINISHES AVAILABLE



HALF CIRCLE PULLS & BACKPLATES ~ 2 STYLES



STYLES AVAILABLE



	TB	PTA	PN	PC	ORB	GBZ	BSN	BLK
3 1/2" cc Half Circle Open Pull	TK53TB	TK53PTA	TK53PN	TK53PC	TK53ORB	TK53GBZ	TK53BSN	TK53BLK
3 1/2" cc Half Circle Backplate	TK54TB	TK54PTA	TK54PN	TK54PC	TK54ORB	TK54GBZ	TK54BSN	TK54BLK
3 1/2" cc Flat Rail Pull	TK55TB	TK55PTA	TK55PN	TK55PC	TK55ORB	TK55GBZ	TK55BSN	TK55BLK
5" cc Flat Rail Pull	TK56TB	TK56PTA	TK56PN	TK56PC	TK56ORB	TK56GBZ	TK56BSN	TK56BLK

NOTE: 5" cc Pull cannot be used with backplate.

PULL ~ 1 SIZE



	TB	PTA	PN	PC	ORB	GBZ	BSN	BLK
4" cc each	TK35TB	TK35PTA	TK35PN	TK35PC	TK35ORB	TK35GBZ	TK35BSN	TK35BLK

NOTE: For detailed dimensions such as overall length, height, base width, etc. see price list or visit TopKnobs.com.

Pulls shown in Polished Nickel

Part Number is specific to shape and finish. cc = measurement center-to-center between the screw holes. Lifetime Warranty for the original purchaser against defects in materials and craftsmanship. Free Samples of any knob and of any pull less than 7", with a \$5 packaging and shipping charge each.

KNOBS & PULLS ~ 2 STYLES



KNOBS ~ 2 STYLES



	TB	PTA	PN	PC	ORB	GBZ	BSN	BLK
3" L Knob - left	TK85TB	TK85PTA	TK85PN	TK85PC	TK85ORB	TK85GBZ	TK85BSN	TK85BLK
3" L Knob - right	TK84TB	TK84PTA	TK84PN	TK84PC	TK84ORB	TK84GBZ	TK84BSN	TK84BLK
5" cc Pull each	TK83TB	TK83PTA	TK83PN	TK83PC	TK83ORB	TK83GBZ	TK83BSN	TK83BLK
1 1/2" L Knob	TK1TB	TK1PTA	TK1PN	TK1PC	TK1ORB	TK1GBZ	TK1BSN	TK1BLK
2 1/2" L Knob/Pull	TK2TB	TK2PTA	TK2PN	TK2PC	TK2ORB	TK2GBZ	TK2BSN	TK2BLK

ARCHED PULLS ~ 4 SIZES Matching Appliance Pulls - see page 83

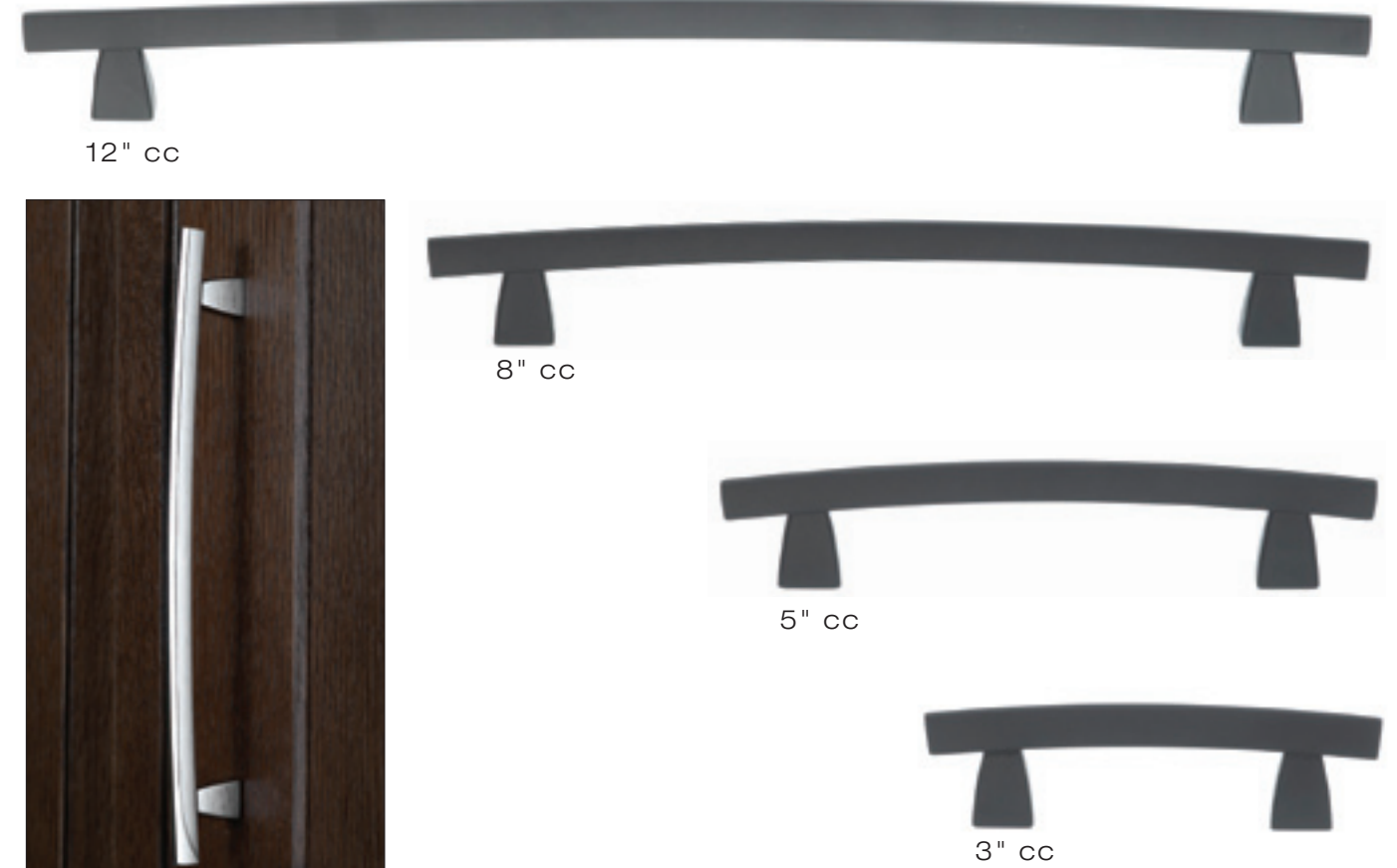

TK7PC - 12" cc matching Appliance Pull in Polished Chrome

Pulls shown in Flat Black

	TB	PTA	PN	PC	ORB	GBZ	BSN	BLK
12" cc	TK6TB	TK6PTA	TK6PN	TK6PC	TK6ORB	TK6GBZ	TK6BSN	TK6BLK
8" cc	TK5TB	TK5PTA	TK5PN	TK5PC	TK5ORB	TK5GBZ	TK5BSN	TK5BLK
5" cc	TK4TB	TK4PTA	TK4PN	TK4PC	TK4ORB	TK4GBZ	TK4BSN	TK4BLK
3" cc	TK3TB	TK3PTA	TK3PN	TK3PC	TK3ORB	TK3GBZ	TK3BSN	TK3BLK

FINISHES AVAILABLE

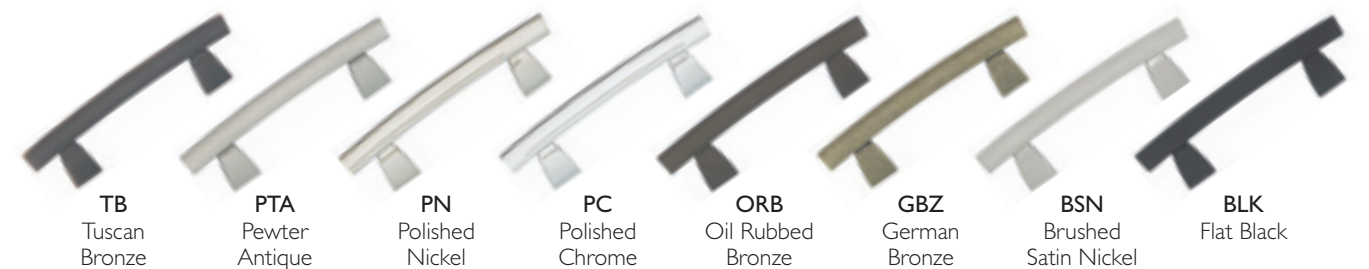

NOTE: For detailed dimensions such as overall length, height, base width, etc. see price list or visit TopKnobs.com.

Part Number is specific to shape and finish. cc = measurement center-to-center between the screw holes. Lifetime Warranty for the original purchaser against defects in materials and craftsmanship. Free Samples of any knob and of any pull less than 7", with a \$5 packaging and shipping charge each.



ALWAYS THE PERFECT OPENING

NEW SS304 Stainless Steel Collection

Approved for indoor/outdoor application

KNOBS ~ 3 STYLES ~ SOLID STAINLESS STEEL



1" w Ball
SS18



1/2" w Flat Round
SS19



5/8" w Indent Knob
SS20



1 3/16" w Indent Knob
SS21



1" w Indent Knob
SS22

T-HANDLE & BAR PULLS ~ SOLID STAINLESS STEEL



2" w T-Handle



6 5/16" cc Solid Bar Pull



3 3/4" cc Solid Bar Pull

Stainless Steel	2"	3" cc	3 3/4" cc	5 1/16" cc	6 5/16" cc	8 13/16" cc	11 11/32" cc	16 3/8" cc	18 7/8" cc	26 15/32" cc	30 1/4" cc	37 3/16" cc
2" T-Handle	SS1	-	-	-	-	-	-	-	-	-	-	-
Solid Bar Pull	-	SS2	SS3	SS4	SS5	SS6	SS7	SS8	SS9	SS10	SS11	SS12

BAR PULLS ~ HOLLOW STAINLESS STEEL



3" cc Hollow Bar Pull

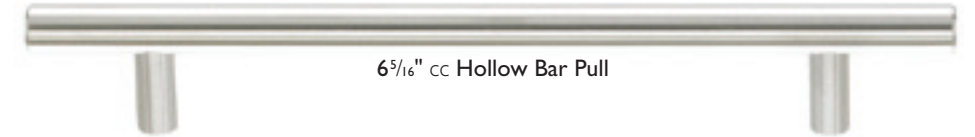

6 5/16" cc Hollow Bar Pull

	1/2" Diameter						9/16" Diameter				
Stainless Steel	3" cc	3 3/4" cc	5 1/16" cc	6 5/16" cc	8 13/16" cc	11 11/32" cc	16 3/8" cc	18 7/8" cc	25 3/16" cc	30 11/16" cc	37 3/16" cc
Hollow Bar Pull	SSH1	SSH2	SSH3	SSH4	SSH5	SSH6	SSH7	SSH8	SSH9	SSH10	SSH11

BAR PULLS ~ 2 STYLES ~ SOLID STAINLESS STEEL



6 5/16" cc Bowed



3 3/4" cc Bent Bar Pull 8mm Diameter



3" cc Bowed



3 3/4" cc Bent Bar Pull 10mm Diameter

Stainless Steel	3" cc	3 3/4" cc	5 1/16" cc	6 5/16" cc	7 9/16" cc	8 13/16" cc	11 11/32" cc
Bowed	SS13	SS14	SS15	SS16	-	SS17	-
Bent 8mm D	SS23	SS24	SS25	SS26	SS27	SS28	SS29
Bent 10mm D	SS30	SS31	SS32	SS33	SS34	SS35	SS36

INFUSE A LITTLE HARMONY INTO YOUR KITCHEN WITH OUR NEW STAINLESS STEEL COLLECTION. NOT ONLY DOES IT EFFORTLESSLY COORDINATE WITH HIGH-END APPLIANCES, OUR PULLS AND KNOBS WON'T RUST IF EXPOSED TO THE ELEMENTS.

WWW.TOPKNOBS.COM
800-499-9095
908-359-6174

Part Number is specific to shape and finish. cc = measurement center-to-center between the screw holes. **Lifetime Warranty** for the original purchaser against defects in materials and craftsmanship. **Free Samples** of any knob and of any pull less than 7", with a \$5 packaging and shipping charge each. **NOTE:** For detailed dimensions such as overall length, height, base width, etc. see price list or visit TopKnobs.com.



ALWAYS THE PERFECT OPENING

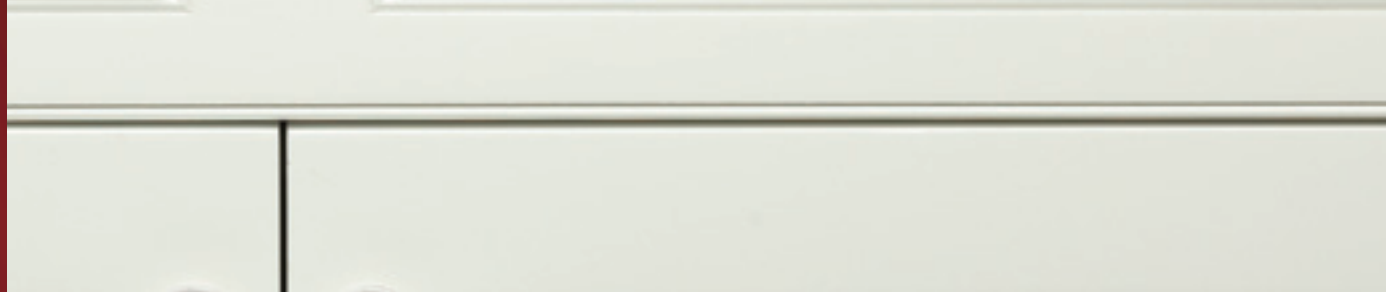

CLEAN, SIMPLE DESIGN BRINGS A CRISP LOOK TO ANY HOME. AND OUR BEST-SELLING COLLECTION CREATES A WELCOMING AMBIANCE THAT COMPLEMENTS BOTH TRADITIONAL AND CONTEMPORARY STYLES.

M1301 on page 17 & M1325 on page 18

BRUSHED SATIN NICKEL & POLISHED NICKEL

Asbury Collection

CUP PULLS ~ 3 STYLES

			Finish	2 1/2" cc Somerset	2 9/16" cc Dakota	2 9/16" cc Cup
2 1/2" cc Somerset Brushed Satin Nickel	2 9/16" cc Dakota Polished Nickel	2 9/16" cc Cup Brushed Satin Nickel	PN	M1302	M1299	M1301
			BSN	M400	M1298	M1300

KNOBS ~ 7 STYLES

3/4" Mushroom Polished Nickel PN	1 1/4" Mushroom Brushed Satin Nickel BSN	1 3/4" Mushroom Polished Nickel PN
1 1/16" Cone Brushed Satin Nickel	1 1/8" Ringed Polished Nickel	1 1/4" Empress Brushed Satin Nickel
1 1/4" Victoria Polished Nickel	1 1/4" Egg Brushed Satin Nickel	1 1/4" Bergen Polished Nickel

	PN	BSN
3/4" Mushroom	M1311	M1310
1 1/4" Mushroom	M1312	M281
1 3/4" Mushroom	M1314	M1313
1 1/16" Cone	M1322	M371
1 1/8" Ringed	M1317	M376
1 1/4" Empress	M1324	M1323
1 1/4" Victoria	M1316	M1315
1 1/4" Egg	M1305	M370
1 1/4" Bergen	M1321	M1119

PULLS ~ 4 STYLES

	5 1/16" cc Bow Polished Nickel
	3 3/4" cc Bow Brushed Satin Nickel
	5 1/16" cc Griggs Brushed Satin Nickel BSN
	5 1/16" cc Buckle Polished Nickel PN
	5 1/16" cc Mandal Brushed Satin Nickel BSN

	PN	BSN
5 1/16" cc Bow	M1264	M381
3 3/4" cc Bow	M1330	M384
5 1/16" cc Griggs	M1268	M391
5 1/16" cc Buckle	M1267	M1266
5 1/16" cc Mandal	M1265	M387



WWW.TOPKNOBS.COM
800-499-9095
908-359-6174

Part Number is specific to shape and finish. cc = measurement center-to-center between the screw holes.

Lifetime Warranty for the original purchaser against defects in materials and craftsmanship.

Free Samples of any knob and of any pull less than 7", with a \$5 packaging and shipping charge each.

NOTE: For detailed dimensions such as overall length, height, base width, etc. see price list or visit TopKnobs.com.

KNOBS ~ 6 STYLES



Finish	5/8" cc Square	1/4" Ring	1/4" Button Faced	1/4" Melon	1/4" Lund	1 3/8" Flat Top
PN	M1320	M1309	M1325	M1319	M1307	M1304
BSN	M1164	M1308	M292	M1318	M1306	M1303

BAR PULLS ~ 3 STYLES

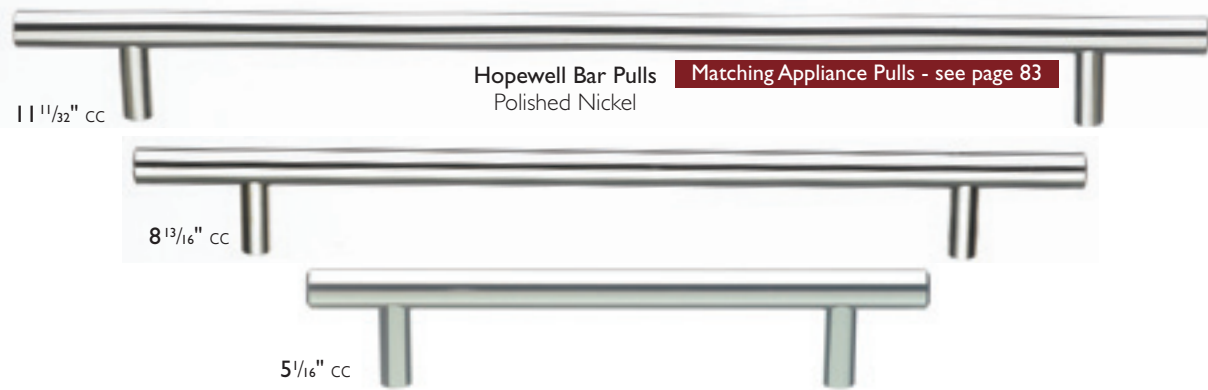

Hopewell Bar Pulls Matching Appliance Pulls - see page 83
Polished Nickel



8 13/16" cc Square Bar Pull
Brushed Satin Nickel

8 13/16" cc Pennington Bar Pull
Polished Nickel

	3" cc	3 3/4" cc	5 1/16" cc	6 5/16" cc	8 13/16" cc	11 1/32" cc	12" cc	15" cc	18 7/8" cc
Hopewell PN	M1269	M1270	M1271	M1272	M1273	M1274	-	M1275	M1276
Square PN	-	M1283	M1284	M1285	M1286	-	M1841	-	-
Square BSN	-	M1161	M1158	M1155	M1152	-	M1838	-	-
Pennington PN	M1254	M1255	M1256	M1257	M1258	-	-	-	-

NOTE: 12" Square Bar Pulls available starting February 2011.

NOTE: For detailed dimensions such as overall length, height, base width, etc. see price list or visit TopKnobs.com.

BRUSHED SATIN NICKEL & POLISHED NICKEL

Asbury Collection

PULLS ~ 5 STYLES

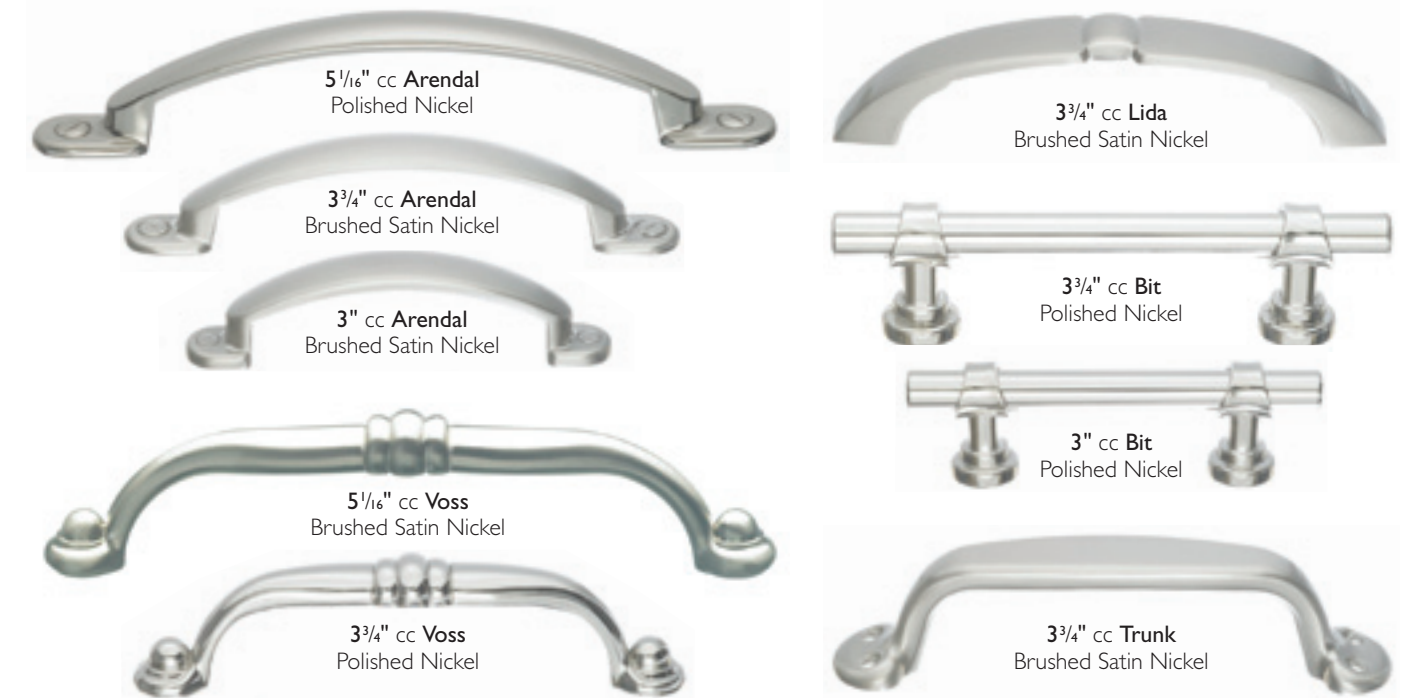

Finish	Arenal			Voss		3 3/4" cc Lida	3 3/4" cc Bit	3" cc Bit	3 3/4" cc Trunk
	5 1/16" cc	3 3/4" cc	3"	5 1/16" cc	3 3/4" cc				
PN	M1329	M1295	M1693	M1297	M1327	M1291	M1289	M1748	M1261
BSN	M1328	M1294	M1692	M1296	M1326	M1290	M1288	M1747	M530

PULLS ~ 4 STYLES



Finish	6" cc Charlotte	4" cc Charlotte	3" cc Charlotte	3 3/4" cc Grace	3 3/4" cc Rue	5 1/16" cc Saddle
PN	M1278	M1280	M1282	M1260	M1293	M1263
BSN	M1277	M1279	M1281	M1259	M1292	M1262

Part Number is specific to shape and finish. cc = measurement center-to-center between the screw holes.
Lifetime Warranty for the original purchaser against defects in materials and craftsmanship.
Free Samples of any knob and of any pull less than 7", with a \$5 packaging and shipping charge each.



ALWAYS THE PERFECT OPENING

IT'S THE EPITOME OF OWNING THE FINEST. EACH PIECE HAND-CAST FROM 90% RECYCLED ARTISAN GRADE BRONZE. EACH PIECE UNIQUE. ASPEN - UNASHAMEDLY BEAUTIFUL. SURPRISINGLY AFFORDABLE. EXPERIENCE IT FOR YOURSELF BY ORDERING A FREE SAMPLE.

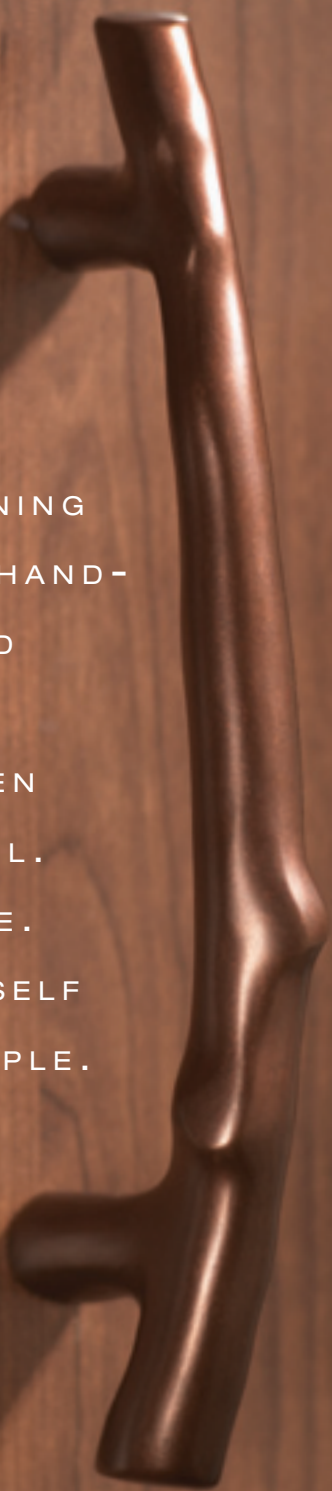

hand finished solid cast bronze ~ Aspen Collection

TWIG PULLS ~ 4 SIZES

Use as Cabinet Pulls and as Appliance Pulls

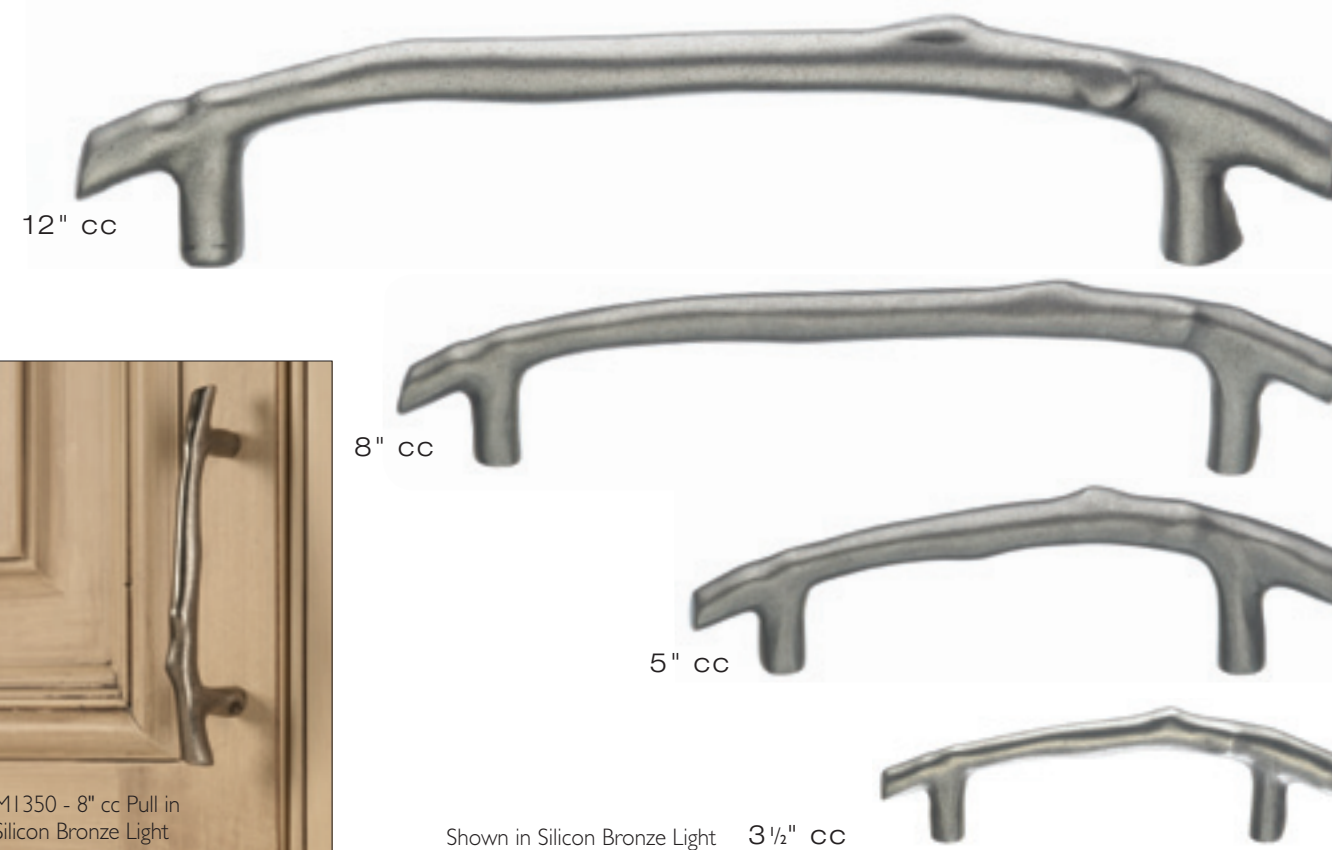

SOLID CAST BRONZE



Finish	12" cc	8" cc	5" cc	3 1/2" cc
SBL	M1355	M1350	M1345	M1340
MCB	M1358	M1353	M1348	M1343
MB	M1357	M1352	M1347	M1342
LB	M1356	M1351	M1346	M1341

www.TopKnobs.com
800-499-9095
908-359-6174

Part Number is specific to shape and finish. cc = measurement center-to-center between the screw holes.
Lifetime Warranty for the original purchaser against defects in materials and craftsmanship.
Free Samples of any knob and of any pull less than 7", with a \$5 packaging and shipping charge each.
NOTE: For detailed dimensions such as overall length, height, base width, etc. see price list or visit TopKnobs.com.



ALWAYS THE PERFECT OPENING

ASPEN COLLECTION...
 INFLUENCED BY THE PAST.
 DESIGNER, DECORATIVE HARDWARE THAT'S CRAFTED WITH TRADITION.



Solid Cast Bronze – For handcrafted luxury at a surprisingly affordable price, discover our Aspen line, created with artisan grade bronze.



Artisan Crafted – What began 5,000 years ago as the standard for creating art, jewelry and armor has become our standard of excellence.

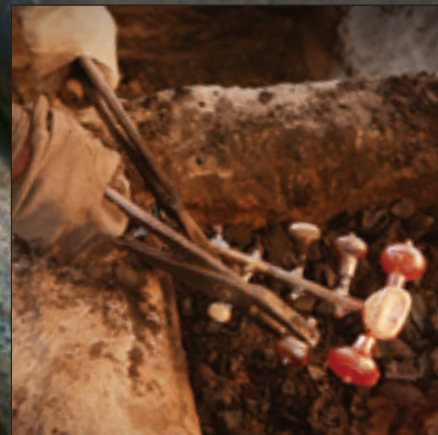

We infuse the intricate copper formulas and traditional techniques of ancient artisans into each handcrafted design in our Aspen Collection.



The Aspen Collection includes 4 finishes and over 160 solid cast bronze knobs and pulls.



Proprietary Sealed Finish – Aspen's light patina and natural distressed look stay protected from age or wear.



Hand Finished Beauty – Every piece in our Aspen Collection is hand-cast and hand-finished, which accentuates the one-of-a-kind look and feel.

hand finished solid cast bronze ~ Aspen Collection

BUTTON KNOBS ~ 2 SIZES

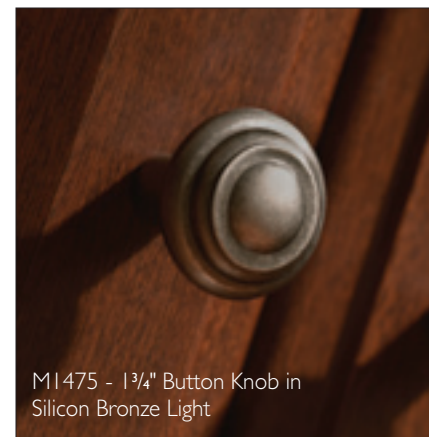

M1475 - 1 3/4" Button Knob in Silicon Bronze Light



1 1/4" Silicon Bronze Light 1 3/4" Mahogany Bronze

Finish	1 1/4" Knob	1 3/4" Knob
SBL	M1470	M1475
MCB	M1473	M1478
MB	M1472	M1477
LB	M1471	M1476

Matching Backplates shown on page 26

PULL & POTATO KNOBS ~ 2 STYLES

CUP PULL

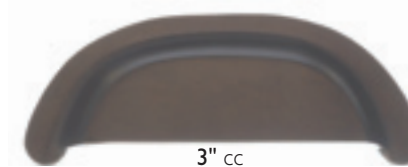

3" cc Mahogany Bronze



1 9/16" Medium Bronze



2" Light Bronze

Finish	3" cc Cup Pull	1 9/16" Knob	2" Knob
SBL	M1410	M1535	M1540
MCB	M1413	M1538	M1543
MB	M1412	M1537	M1542
LB	M1411	M1536	M1541

SQUARE KNOBS ~ 4 SIZES



M1516 - 1 1/2" Square Knob in Light Bronze

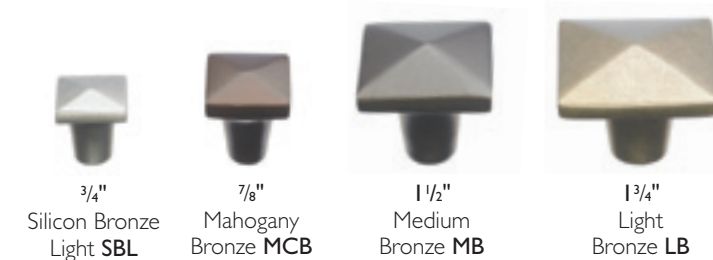

Finish	3/4"	7/8"	1 1/2"	1 3/4"
SBL	M1505	M1510	M1515	M1520
MCB	M1508	M1513	M1518	M1523
MB	M1507	M1512	M1517	M1522
LB	M1506	M1511	M1516	M1521

WWW.TOPKNOBS.COM
 800-499-9095
 908-359-6174

Part Number is specific to shape and finish. cc = measurement center-to-center between the screw holes.

Lifetime Warranty for the original purchaser against defects in materials and craftsmanship.

Free Samples of any knob and of any pull less than 7", with a \$5 packaging and shipping charge each.

NOTE: For detailed dimensions such as overall length, height, base width, etc. see price list or visit TopKnobs.com.



hand finished solid cast bronze ~ Aspen Collection

ROUNDED PULLS ~ 5 SIZES

Use as Cabinet Pulls and as Appliance Pulls

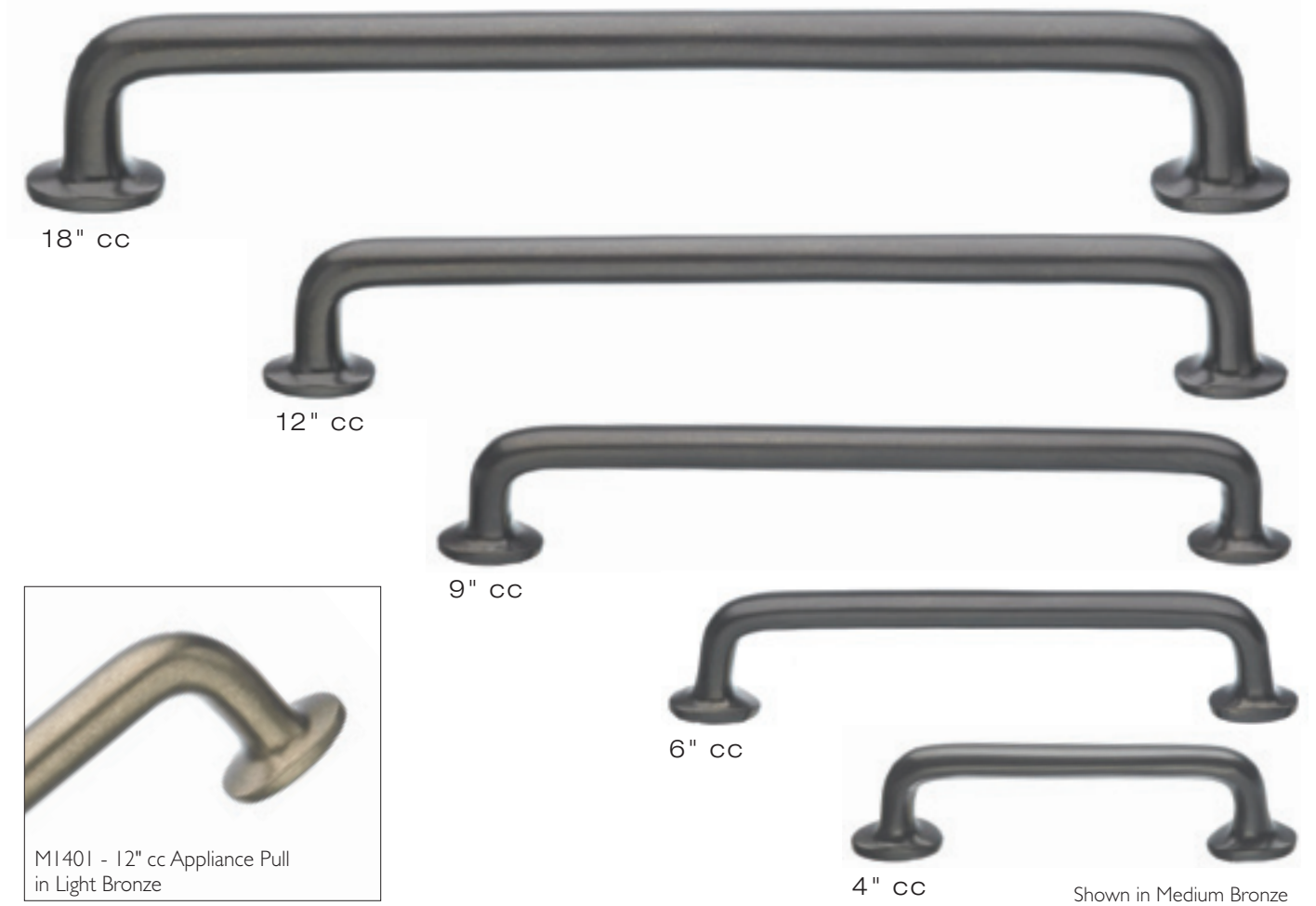

SOLID CAST BRONZE



Finish	18" cc	12" cc	9" cc	6" cc	4" cc
SBL	M1405	M1400	M1395	M1390	M1385
MCB	M1408	M1403	M1398	M1393	M1388
MB	M1407	M1402	M1397	M1392	M1387
LB	M1406	M1401	M1396	M1391	M1386

Part Number is specific to shape and finish. cc = measurement center-to-center between the screw holes.

Lifetime Warranty for the original purchaser against defects in materials and craftsmanship.

Free Samples of any knob and of any pull less than 7", with a \$5 packaging and shipping charge each.



NOTE: For detailed dimensions such as overall length, height, base width, etc. see price list or visit TopKnobs.com.

FLAT SIDED PULLS ~ 5 SIZES

Use as Cabinet Pulls and as Appliance Pulls

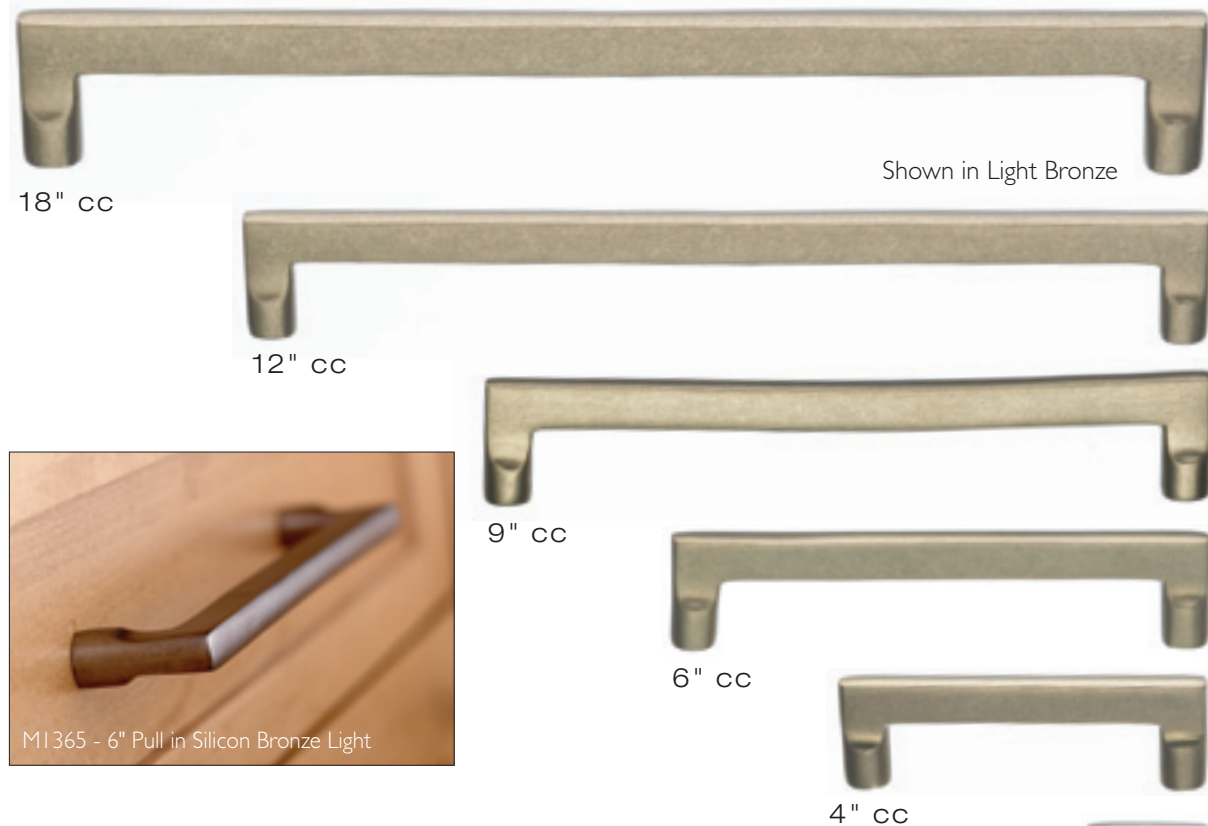

Finish	18" cc	12" cc	9" cc	6" cc	4" cc	7/8" cc Knob
SBL	M1380	M1375	M1370	M1365	M1360	M1500
MCB	M1383	M1378	M1373	M1368	M1363	M1503
MB	M1382	M1377	M1372	M1367	M1362	M1502
LB	M1381	M1376	M1371	M1366	M1361	M1501

7/8" cc Flat Sided Knob
Silicon Bronze Light

DECORATIVE BACKPLATES

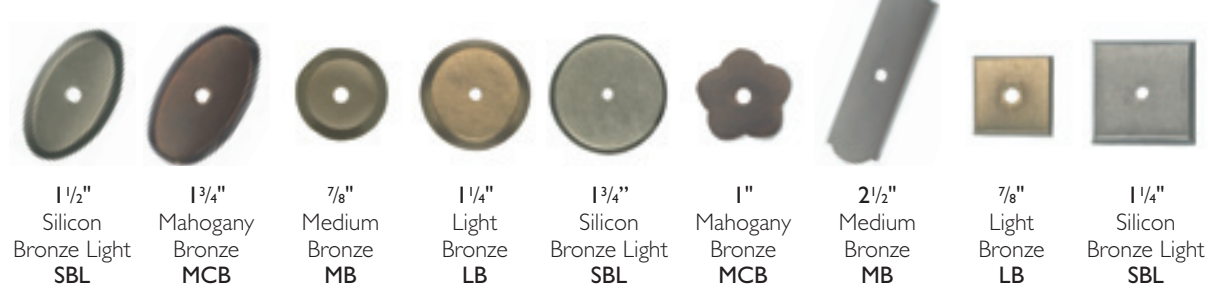

Finish	1 1/2" Oval	1 3/4" Oval	7/8" Round	1 1/4" Round	1 3/4" Round	1" Flower	2 1/2" Rectangle	7/8" Square	1 1/4" Square
SBL	M1435	M1440	M1455	M1460	M1465	M1425	M1430	M1445	M1450
MCB	M1438	M1443	M1458	M1463	M1468	M1428	M1433	M1448	M1453
MB	M1437	M1442	M1457	M1462	M1467	M1427	M1432	M1447	M1452
LB	M1436	M1441	M1456	M1461	M1466	M1426	M1431	M1446	M1451

PEAK KNOBS ~ 4 SIZES



M1485 & M1425 - 1 1/4" Peak Knob with Flower Backplate in Silicon Bronze Light



Finish	1"	1 1/4"	1 5/8"	2"
SBL	M1480	M1485	M1490	M1495
MCB	M1483	M1488	M1493	M1498
MB	M1482	M1487	M1492	M1497
LB	M1481	M1486	M1491	M1496

Matching Backplates shown on page 26

ROUND KNOBS ~ 4 SIZES

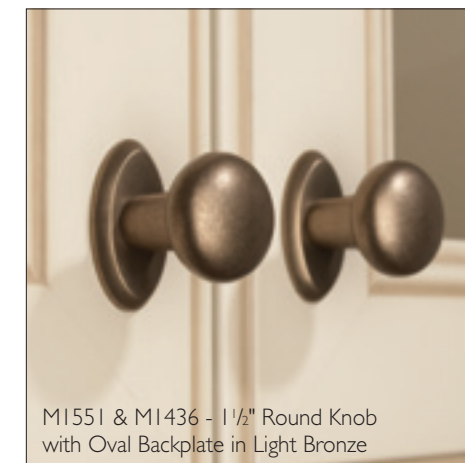

M1551 & M1436 - 1 1/2" Round Knob with Oval Backplate in Light Bronze



Finish	7/8"	1 1/8"	1 3/8"	1 5/8"
SBL	M1545	M1550	M1555	M1560
MCB	M1548	M1553	M1558	M1563
MB	M1547	M1552	M1557	M1562
LB	M1546	M1551	M1556	M1561

Matching Backplates shown on page 26

EGG KNOBS ~ 2 SIZES

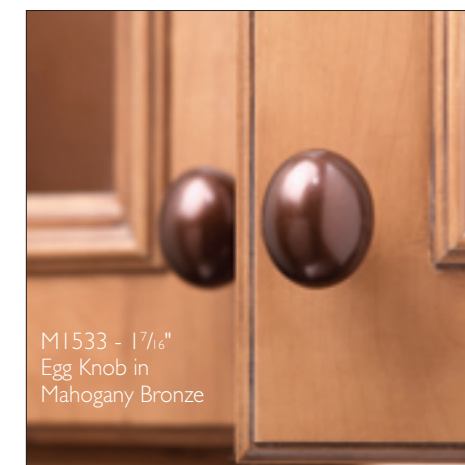

M1533 - 1 7/16" Egg Knob in Mahogany Bronze



Finish	1 3/16"	1 7/16"
SBL	M1525	M1530
MCB	M1528	M1533
MB	M1527	M1532
LB	M1526	M1531

Matching Backplates shown on page 26



NOTE: For detailed dimensions such as overall length, height, base width, etc. see price list or visit TopKnobs.com.

Part Number is specific to shape and finish. cc = measurement center-to-center between the screw holes. Lifetime Warranty for the original purchaser against defects in materials and craftsmanship. Free Samples of any knob and of any pull less than 7", with a \$5 packaging and shipping charge each.



ALWAYS THE PERFECT OPENING

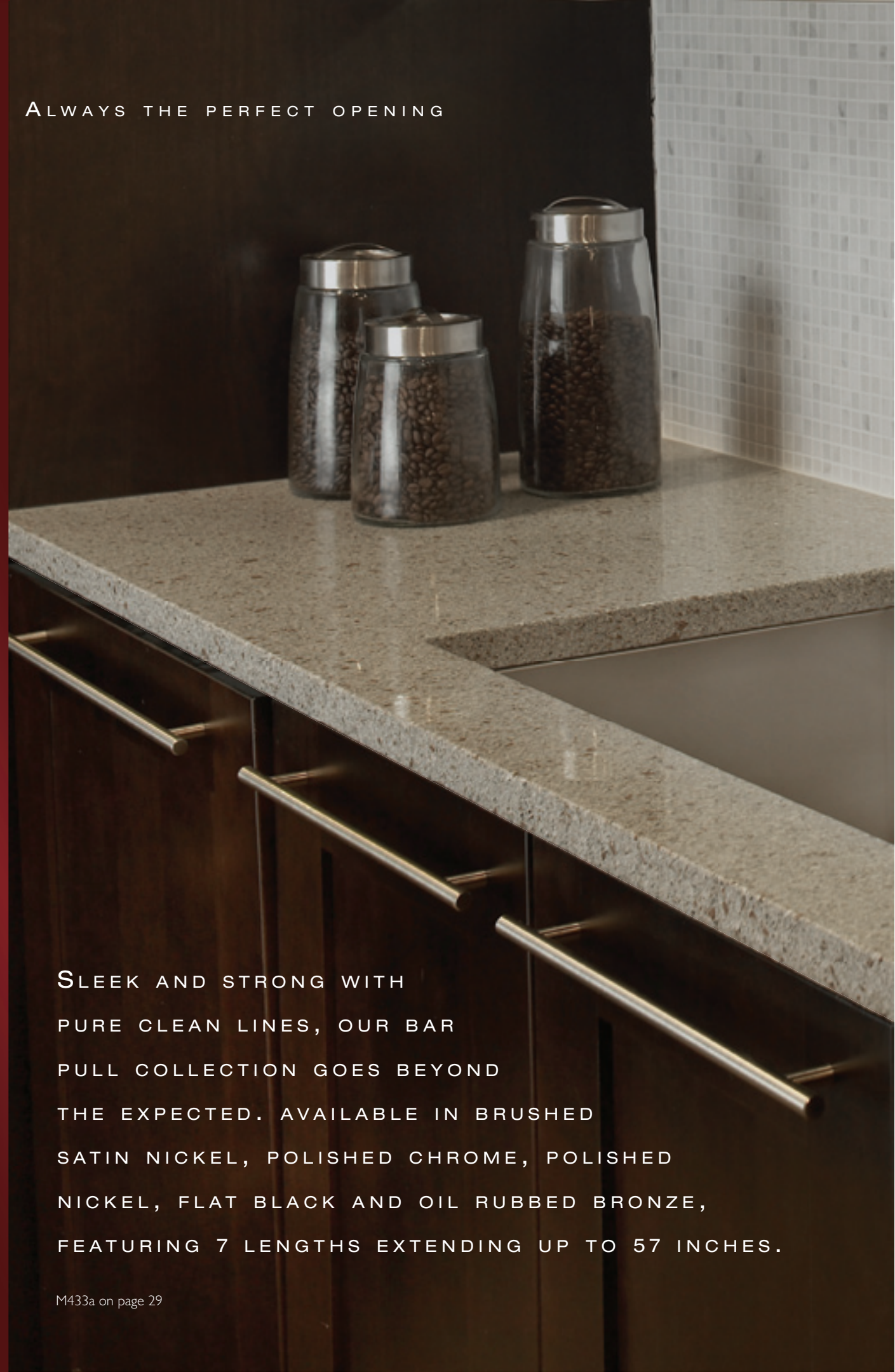

SLEEK AND STRONG WITH PURE CLEAN LINES, OUR BAR PULL COLLECTION GOES BEYOND THE EXPECTED. AVAILABLE IN BRUSHED SATIN NICKEL, POLISHED CHROME, POLISHED NICKEL, FLAT BLACK AND OIL RUBBED BRONZE, FEATURING 7 LENGTHS EXTENDING UP TO 57 INCHES.

M433a on page 29

HOPEWELL BAR PULLS ~ 14 SIZES Matching Appliance Pulls - see page 83



FINISHES AVAILABLE



	PN	ORB	BSN	BLK
NEW 3" cc	M1269	M757a	M429A	M987
3 3/4" cc	M1270	M757	M429	M988
5 1/8" cc	M1271	M758	M430	M989
6 5/16" cc	M1272	M759	M431	M990
8 13/16" cc	M1273	M760	M432	M991
11 11/32" cc	M1274	M761	M433	M992
15" cc	M1275	M761a	M433a	M993
18 7/8" cc	M1276	M762	M434	M994
26 15/32" cc	-	M763	M435	M995
30 1/4" cc	-	M764	M436	M996
(37 1/8" cc) 2 x 18 9/16" cc	-	M764a	M436A	M997
(43 1/8" cc) 2 x 21 9/16" cc	-	-	M436B	-
(47 1/8" cc) 2 x 23 9/16" cc	-	-	M436C	-
(54 1/4" cc) 2 x 27 1/8" cc	-	-	M436D	-

www.TopKnobs.com
 800-499-9095
 908-359-6174

Part Number is specific to shape and finish. cc = measurement center-to-center between the screw holes.

Lifetime Warranty for the original purchaser against defects in materials and craftsmanship.

Free Samples of any knob and of any pull less than 7", with a \$5 packaging and shipping charge each.

NOTE: For detailed dimensions such as overall length, height, base width, etc. see price list or visit TopKnobs.com.



ALWAYS THE PERFECT OPENING

NEW Additions

BAR PULLS ~ 14 SIZES

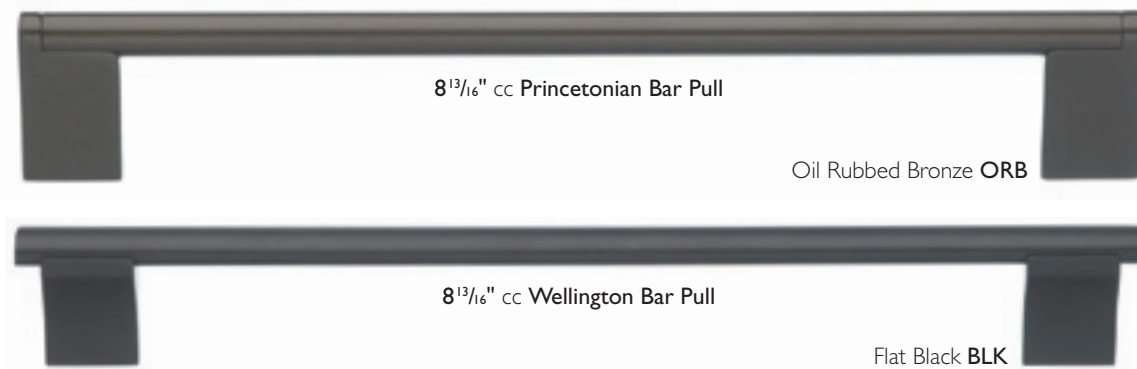

	Pennington Bar Pulls				Princetonian Bar Pulls			Wellington Bar Pulls		
	PN	ORB	BSN	BLK	ORB	BSN	BLK	ORB	BSN	BLK
3" cc	M1254	M1029	M1001	M1015	M1068	M1040	M1054	M1105	M1079	M1093
3 3/4" cc	M1255	M1030	M1002	M1016	M1069	M1041	M1055	M1106	M1080	M1094
5 1/16" cc	M1256	M1031	M1003	M1017	M1070	M1042	M1056	M1107	M1081	M1095
6 5/16" cc	M1257	M1032	M1004	M1018	M1071	M1043	M1057	M1108	M1082	M1096
8 13/16" cc	M1258	M1033	M1005	M1019	M1072	M1044	M1058	M1109	M1083	M1097
11 1/32" cc	-	M1034	M1006	M1020	M1073	M1045	M1059	M1110	M1084	M1098
15" cc	-	M1035	M1007	M1021	M1074	M1046	M1060	M1111	M1085	M1099
18 7/8" cc	-	M1036	M1008	M1022	M1075	M1047	M1061	M1112	M1086	M1100
26 15/32" cc	-	M1037	M1009	M1023	-	-	-	-	-	-
30 1/4" cc	-	M1038	M1010	M1024	-	-	-	-	-	-
37 3/16" cc	-	M1039	M1011	M1025	-	-	-	-	-	-
2 x 13 3/16" cc	-	-	-	-	M1076	M1048	M1062	M1113	M1087	M1101
2 x 15 1/16" cc	-	-	-	-	M1077	M1049	M1063	M1114	M1088	M1102
2 x 18 9/16" cc	-	-	-	-	M1078	M1050	M1064	M1115	M1089	M1103

NEW PULLS & KNOB ~ 3 STYLES

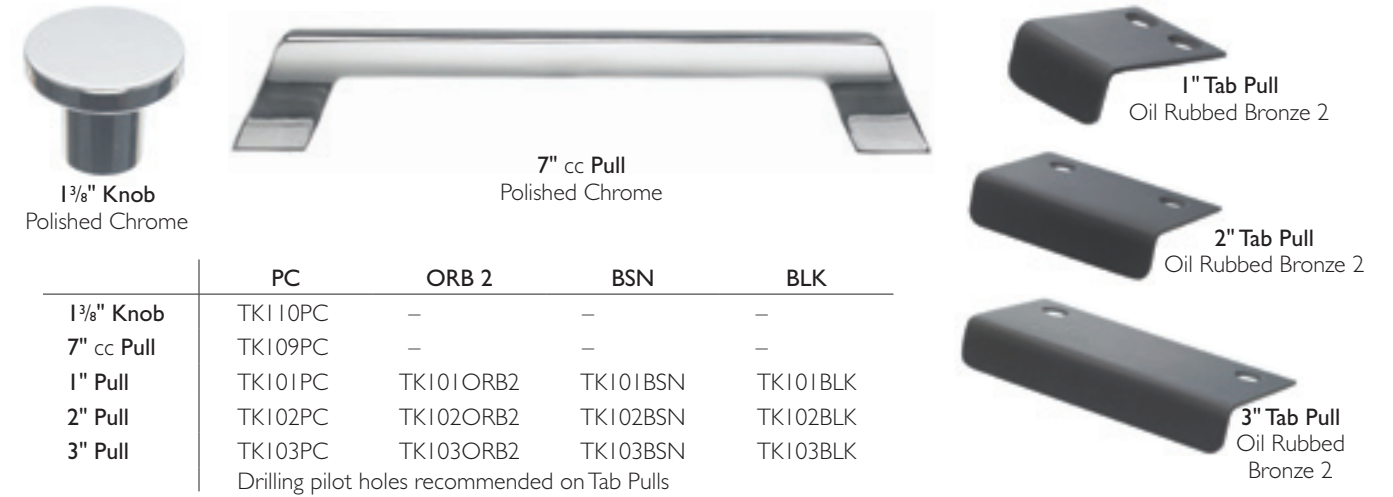

	PC	ORB 2	BSN	BLK
1 3/8" Knob	TK110PC	-	-	-
7" cc Pull	TK109PC	-	-	-
1" Pull	TK101PC	TK101ORB2	TK101BSN	TK101BLK
2" Pull	TK102PC	TK102ORB2	TK102BSN	TK102BLK
3" Pull	TK103PC	TK103ORB2	TK103BSN	TK103BLK

Drilling pilot holes recommended on Tab Pulls

NEW SOLID BRASS LATCHES

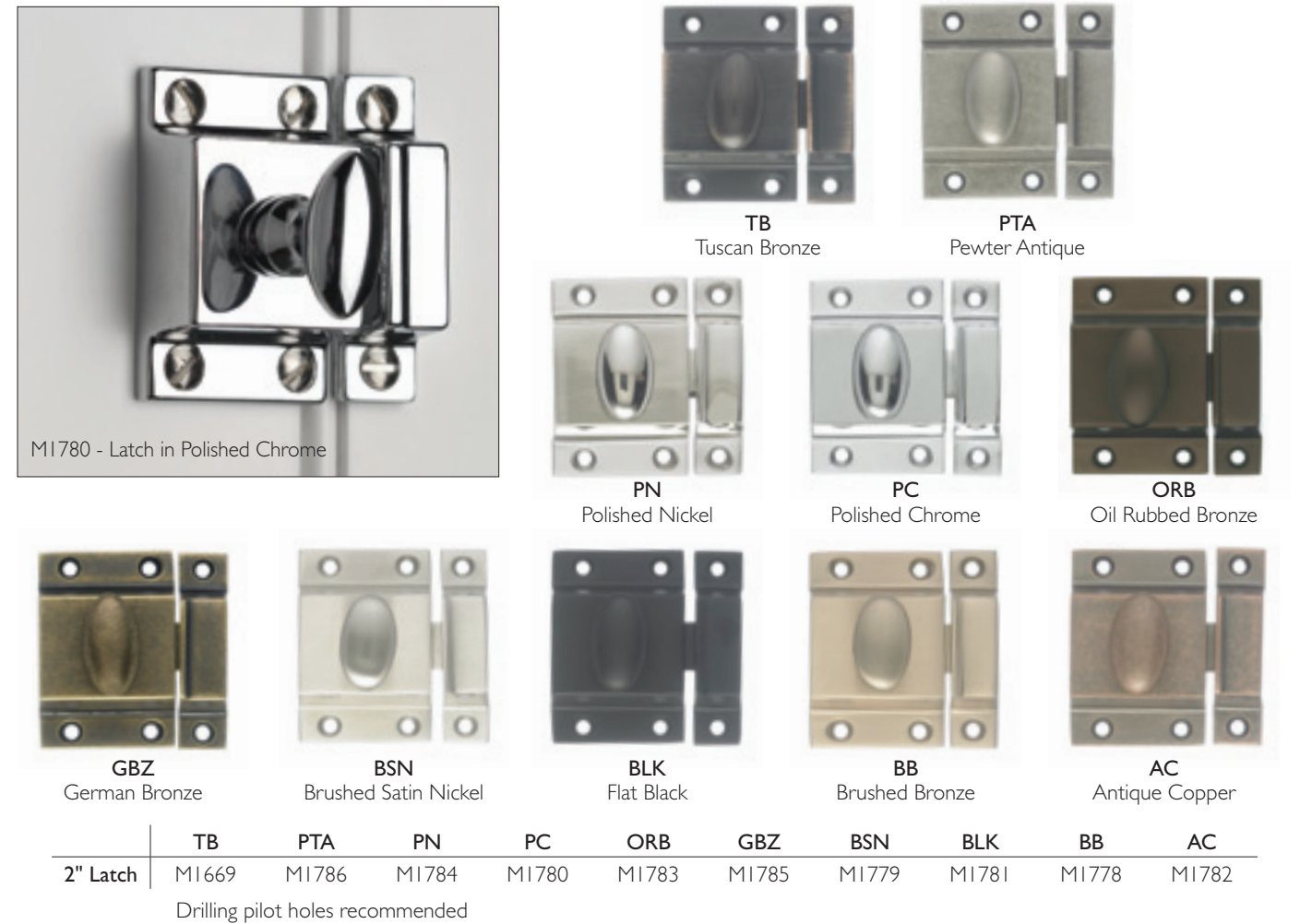

	TB	PTA	PN	PC	ORB	GBZ	BSN	BLK	BB	AC
2" Latch	M1669	M1786	M1784	M1780	M1783	M1785	M1779	M1781	M1778	M1782

Drilling pilot holes recommended



WWW.TOPKNOBS.COM
800-499-9095
908-359-6174

NOTE: For detailed dimensions such as overall length, height, base width, etc. see price list or visit TopKnobs.com.

Part Number is specific to shape and finish. cc = measurement center-to-center between the screw holes. **Lifetime Warranty** for the original purchaser against defects in materials and craftsmanship. **Free Samples** of any knob and of any pull less than 7", with a \$5 packaging and shipping charge each.



ALWAYS THE PERFECT OPENING



NOTHING EVOKES OLD WORLD ARTISTRY AND CRAFTSMANSHIP LIKE THE RUSTIC SOLID BRASS AND HAMMERED IRON DETAILS OF OUR EXCEPTIONAL BRITANNIA COLLECTION. EXPERIENCE IT FOR YOURSELF BY ORDERING A FREE SAMPLE.

M30 on page 34

Britannia Collection

SQUARE INSET PULLS & KNOBS ~ 6 SIZES

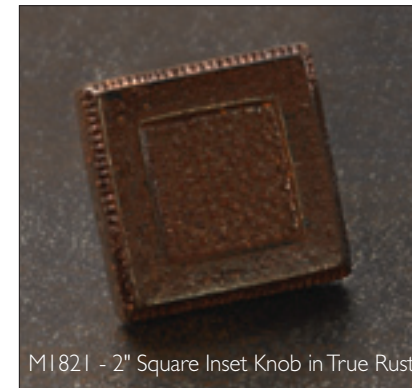
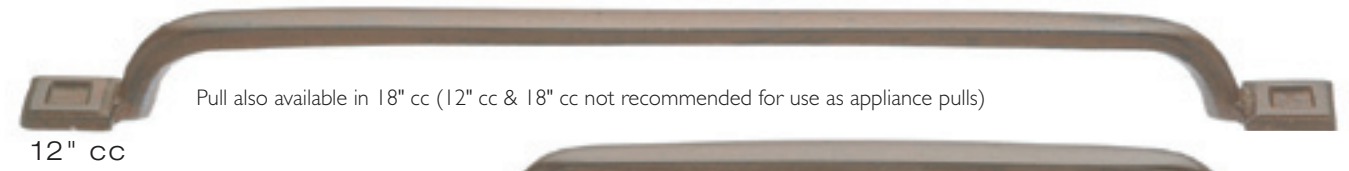

Finish	18" cc	12" cc	8" cc	5 1/16" cc	1 3/16" Square Knob	1 5/16" Inset Knob	2" Inset Knob
NEW TR	M1830	M1829	M1828	M1827	M1810	M1822	M1821
NEW CI	M1826	M1825	M1824	M1823	M1809	M1820	M1819

PULLS ~ 3 STYLES Matching Appliance Pulls - see page 88



Finish	Cup Pull	Thin Pulls				Channel Pulls		
	2 1/2" cc	18" cc	12" cc	8" cc	3 13/16" cc	18" cc	12" cc	6 1/4" cc
NEW TR	M1812	M1808	M1807	M1806	M1805	M1818	M1817	M1816
NEW CI	M1811	M1804	M1803	M1802	M1801	M1815	M1814	M1813

www.TOPKNOBS.COM
800-499-9095
908-359-6174

Part Number is specific to shape and finish. cc = measurement center-to-center between the screw holes.

Lifetime Warranty for the original purchaser against defects in materials and craftsmanship.

Free Samples of any knob and of any pull less than 7", with a \$5 packaging and shipping charge each.

NOTE: For detailed dimensions such as overall length, height, base width, etc. see price list or visit TopKnobs.com.

KNOBS ~ 6 STYLES



	VDGE	TB	RST	PN	PTL	PTA	PC	ORB	OEC	GBZ	DAB	BSN
Victoria	-	-	-	M1316	-	M25	-	-	M26	-	-	M1315
London	-	-	-	-	-	M22	-	-	M23	M24	-	-
Empress	M13	M1613	M12	M1324	-	M10	M1612	M768	M11	-	-	M1323
Ascot	-	-	-	-	-	M14	-	M771	M15	M16	-	-
Devon	M9	-	M8	-	-	M6	-	-	M7	-	-	-
Canterbury	M29	-	M27	-	M30	M464	-	-	M231	M31	M28	-

FINISHES AVAILABLE ~ 1 1/4" CANTERBURY SHOWN



KNOBS & PULLS ~ 4 STYLES



	RST	CI	DAB
3 3/4" cc Fixed Pull	M40	M47	M41
2 1/2" cc Vertical Latch	M32	M34	M33
1 1/4" Warwick Knob	M38	M48	M42
1 1/2" Warwick Knob	M39	M49	M43
1 1/4" Paris Knob Mottled	M58	-	M44
1 1/4" Paris Knob Smooth	-	M50	-

VERSAILLES PULLS, T-HANDLE & STRIKEPLATE

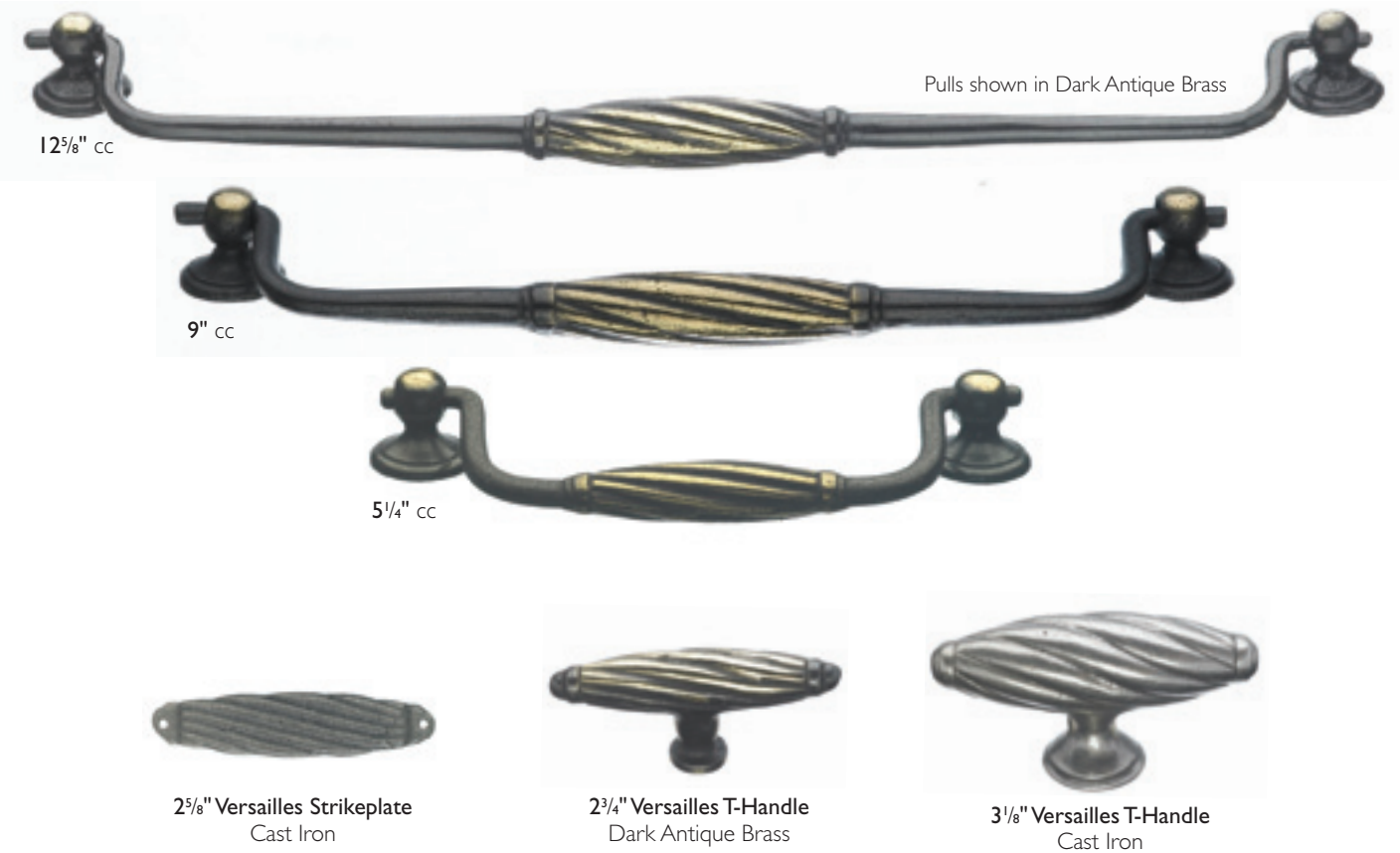

Finish	12 5/8" cc	9" cc	5 1/4" cc	2 5/8" Strikeplate	2 3/4" T-Handle	3 1/8" T-Handle
RST	-	-	-	-	M35	M53
CI	M60	M52	M51	M56	M37	M55
DAB	M59	M46	M45	M57	M36	M54

PULLS ~ 2 STYLES



	VDG	RST	PTL	OEC	GBZ	DAB
3 3/4" cc Oxford Pull	-	-	M2	M215	M1	M3
3 3/4" cc Eton Pull	M21	M20	M18	M216	M17	M19

Part Number is specific to shape and finish. cc = measurement center-to-center between the screw holes.
Lifetime Warranty for the original purchaser against defects in materials and craftsmanship.
Free Samples of any knob and of any pull less than 7", with a \$5 packaging and shipping charge each.



ALWAYS THE PERFECT OPENING



INSPIRED BY CENTURIES GONE BY, OUR CHATEAU COLLECTION FEATURES THE FINEST CRAFTSMANSHIP. FROM SHAKER AND MISSION INFLUENCES TO ENGLISH PORCELAIN AND HAMMERED IRON DETAILS, FOR THE WELL APPOINTED HOME... OR CASTLE!

M463 on page 39

Chateau Collection

KNOB & PULLS ~ 5 STYLES



M255 & M245 - 1 3/8" Square Knob & 5 1/2" Backplate in Dark Antique Brass



1 3/8" Square Knob & 5 1/2" Backplate
Dark Antique Brass



3 13/16" cc
Ring Pull
Pewter Light



1 3/8" Square Knob
Rust



3" cc Plate Pull
Old English Copper



5 1/2" Backplate for Knob
Pewter Light



5 1/2" cc Pull & Backplate Set
Dark Antique Brass

	RST	PTL	OEC	GBZ	DAB
1 3/8" Square Knob	M252	M253	M256	M254	M255
5 1/2" Backplate	M242	M243	M246	M244	M245
3 13/16" cc Ring Pull	M237	M238	M241	M239	M240
3" cc Plate Pull	M232	M233	M236	M234	M235
5 1/2" cc Pull & Backplate	M247	M248	M251	M249	M250

FINISHES AVAILABLE



RST
Rust



PTL
Pewter Light



OEC
Old English Copper



GBZ
German Bronze



DAB
Dark Antique Brass



WWW.TOPKNOBS.COM
800-499-9095
908-359-6174

Part Number is specific to shape and finish. cc = measurement center-to-center between the screw holes.

Lifetime Warranty for the original purchaser against defects in materials and craftsmanship.

Free Samples of any knob and of any pull less than 7", with a \$5 packaging and shipping charge each.

NOTE: For detailed dimensions such as overall length, height, base width, etc. see price list or visit TopKnobs.com.

KNOBS ~ 3 STYLES



1 1/2" Warwick Oval Cast Iron 1 3/8" Square Iron Knob-Dimpled Rust 1 3/8" Square Iron Knob-Smooth Dark Antique Brass

Finish	1 1/2" Warwick	1 3/8" Dimpled	1 3/8" Smooth
RST	M72	M262	M265
DAB	M71	M261	M264
CI	M70	M260	M263

PULLS ~ 3 STYLES



2 1/2" cc Warwick Cup Pull Cast Iron 4 1/16" cc Fleur Pull Dark Antique Brass 5 1/16" cc Brunel Pull Rust



Finish	2 1/2" cc Warwick Cup Pull	4 1/16" cc Fleur Pull	5 1/16" cc Brunel Pull
RST	M66	M268	M69
DAB	M65	M267	M68
CI	M64	M266	M67

KNOBS & BACKPLATE ~ 3 STYLES



1" Pommel Knob Pewter 1 3/8" Twist Knob Dark Antique Brass 1 3/8" Thames Backplate Rust

Finish	1" Pommel Knob	1 3/8" Twist Knob	1 3/8" Backplate
RST	M441	M438	M444
PT	M440	M437	M443
DAB	M442	M439	M445

THAMES TWIST BAR PULLS ~ 3 SIZES



11 1/32" cc



7 9/16" cc



1 3/8" Thames Backplate 3 3/4" cc Pulls & Backplate shown in Rust

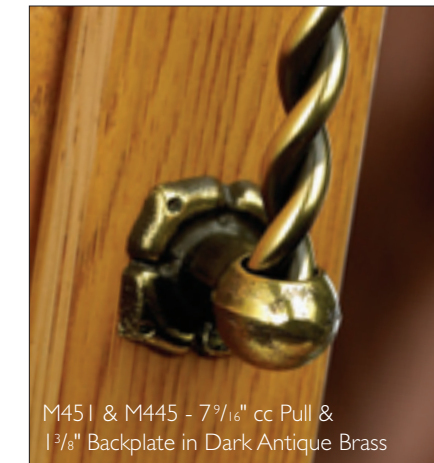

M451 & M445 - 7 9/16" cc Pull & 1 3/8" Backplate in Dark Antique Brass

Finish	11 1/32" cc	7 9/16" cc	3 3/4" cc	1 3/8" Backplate each
RST	M453	M450	M447	M444
PT	M452	M449	M446	M443
DAB	M454	M451	M448	M445

THAMES PULLS ~ 4 STYLES



5 1/16" cc Drop Pull Pewter



3 3/4" cc Latch Pull Dark Antique Brass



3 3/4" cc D-Pull Rust



2 1/2" cc Cup Pull Dark Antique Brass

Finish	5 1/16" cc Drop Pull	2 1/2" cc Cup Pull	3 3/4" cc D-Pull	3 3/4" cc Latch Pull
RST	M501	M456	M459	M462
PT	M500	M455	M458	M461
DAB	M502	M457	M460	M463



STONE KNOBS ~ 1 SIZE



	1 3/8"	1 3/8"	1 3/8"	1 3/8"	1 3/8"
	Black Absolute Granite	Blue Pearl Granite	Green Ubatuba Granite	Green Marble	Blue Stone
Stem Finish	Black Absolute	Blue Pearl	Green Ubatuba	Green Marble	Blue Stone
Brass	M118	M119	M120	M121	M122
Chrome	M118C	M119C	M120C	M121C	M122C



	1 3/8"	1 3/8"	1 3/8"	1 3/8"	1 3/8"
	Honed Red Travertine	Luna Pearl Granite	Paradiso Granite	Verde Maritaka Granite	Tumbled Green Marble
Stem Finish	Honed Red Travertine	Luna Pearl	Pardiso Granite	Verde Maritaka	Tumbled Green
Brass	M123	M124	M125	M126	M127
Chrome	M123C	M124C	M125C	M126C	M127C



	1 3/8"	1 3/8"	1 3/8"	1 3/8"	1 3/8"
	Dakota Mahogany Granite	Giallo Veneziano Granite	Kashmire White Granite	Crema Marfil Granite	Tumbled Travertine
Stem Finish	Dakota Mahogany	Giallo Veneziano	Kashmire White	Crema Marfil	Tumbled Travertine
Brass	M128	M129	M130	M131	M132
Chrome	M128C	M129C	M130C	M131C	M132C

CUP PULLS ~ 2 STYLES



	3 15/16" cc Abbot Cup Pull Cast Iron CI	3 11/16" cc Neptune Cup Pull Dark Antique Brass DAB	Neptune Cup Pull Rust RST
Finish	Abbot	Neptune	
RST	M63	M259	
DAB	M62	M258	
CI	M61	M257	

CERAMIC KNOBS & T-HANDLES ~ 3 SIZES



1 1/8" Small Knob Pewter Antique PTA, Old English Copper OEC, German Bronze GBZ
1 3/8" Large Knob Pewter Antique PTA, Old English Copper OEC, German Bronze GBZ



3 3/8" T-Handle Bone Crackle/Pewter Antique, Antique Crackle/Old English Copper, White/German Bronze

Finish	Small Knobs			Large Knobs			T-Handle		
	Bone	Antique	White	Bone	Antique	White	Bone	Antique	White
PTA	M109	M110	M111	M100	M101	M102	M73	M74	M75
OEC	M112	M113	M114	M103	M104	M105	M76	M77	M78
GBZ	M115	M116	M117	M106	M107	M108	M79	M80	M81

CERAMIC PULLS ~ 2 SIZES



Finish	Drop Pulls			D-Pulls		
	Bone	Antique	White	Bone	Antique	White
PTA	M91	M92	M93	M82	M83	M84
OEC	M94	M95	M96	M85	M86	M87
GBZ	M97	M98	M99	M88	M89	M90

NOTE: For detailed dimensions such as overall length, height, base width, etc. see price list or visit TopKnobs.com.

Part Number is specific to shape and finish. cc = measurement center-to-center between the screw holes. Lifetime Warranty for the original purchaser against defects in materials and craftsmanship. Free Samples of any knob and of any pull less than 7", with a \$5 packaging and shipping charge each.



ALWAYS THE PERFECT OPENING



BEDAZZLED WITH SOPHISTICATION, ADD A TOUCH OF SPARKLE AND ENCHANTMENT TO YOUR HOME... NOT TO MENTION COLOR AND TEXTURE. AVAILABLE IN 4 STYLES AND UP TO 8 GLAMOROUS COLORS.

TK128BSN on page 43

Crystal Collection

CRYSTAL KNOBS ~ 3 STYLES

Base Finish	NEW 1 1/8" Melon	NEW 1 1/8" Octagon
Black	–	TK137PC
PC	TK127PC	TK128PC
Wine	–	TK138PC
Black	–	TK137BSN
BSN	TK127BSN	TK128BSN
Wine	–	TK138BSN

1 1/8" Amber 1 1/8" Black 1 1/8" Blue 1 1/8" Clear 1 3/8" Green 1 3/8" Light Blue 1 3/8" Pink 1 3/8" Wine

Base Finish	NEW Amber	NEW Black	NEW Blue	Clear	NEW Green	NEW Light Blue	NEW Pink	NEW Wine
1 1/8" PC	TK111PC	TK115PC	TK123PC	TK125PC	TK119PC	TK113PC	TK117PC	TK121PC
1 1/8" BSN	TK111BSN	TK115BSN	TK123BSN	TK125BSN	TK119BSN	TK113BSN	TK117BSN	TK121BSN
NEW 1 3/8" PC	TK112PC	TK116PC	TK124PC	TK126PC	TK120PC	TK114PC	TK118PC	TK122PC
NEW 1 3/8" BSN	TK112BSN	TK116BSN	TK124BSN	TK126BSN	TK120BSN	TK114BSN	TK118BSN	TK122BSN

CRYSTAL CENTER KNOBS ~ 4 SIZES

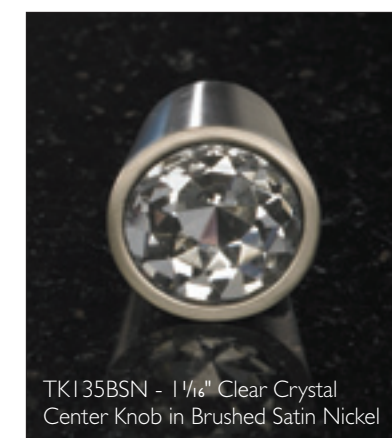

3/4" Black Crystal Center 3/4" Blue Crystal Center 3/4" Wine Crystal Center 1 1/16" Clear Crystal Center

Brushed Satin Nickel	3/4"	1 1/16"
NEW Black	TK130BSN	TK129BSN
Blue	TK132BSN	TK131BSN
Wine	TK134BSN	TK133BSN
Clear	TK136BSN	TK135BSN

www.TOPKNOBS.COM
800-499-9095
908-359-6174

Part Number is specific to shape and finish. cc = measurement center-to-center between the screw holes.

Lifetime Warranty for the original purchaser against defects in materials and craftsmanship.

Free Samples of any knob and of any pull less than 7", with a \$5 packaging and shipping charge each.

NOTE: For detailed dimensions such as overall length, height, base width, etc. see price list or visit TopKnobs.com.



ALWAYS THE PERFECT OPENING



Dakota Collection

KNOBS & CUP PULL ~ 3 STYLES



1/4" Round Knob
Patina Rouge



1/2" Oval Knob
Oil Rubbed Bronze



2 7/16" cc Dakota Cup Pull
Pewter Antique

Finish	1/4" Round Knob	1/2" Oval Knob	2 7/16" cc Dakota Cup Pull
NEW TB	M1608	–	–
PTA	M1223	M1235	M1196
NEW PN	M1611	–	M1299
NEW PC	M1610	–	–
PAR	M1222	M1234	M1195
ORB	M1221	M1233	M1194
NEW BSN	M1609	–	M1298

BIT PULLS ~ 2 SIZES



	TB	PTA	PN	PC	PAR	ORB	GBZ	BSN	BLK	BB	AC
3/4" cc	M1648	M1199	M1289	–	M1198	M1197	–	M1288	–	M1649	–
NEW 3" cc	M1745	M1754	M1748	M1749	M1751	M1752	M1753	M1747	M1755	M1750	M1746

FINISHES AVAILABLE

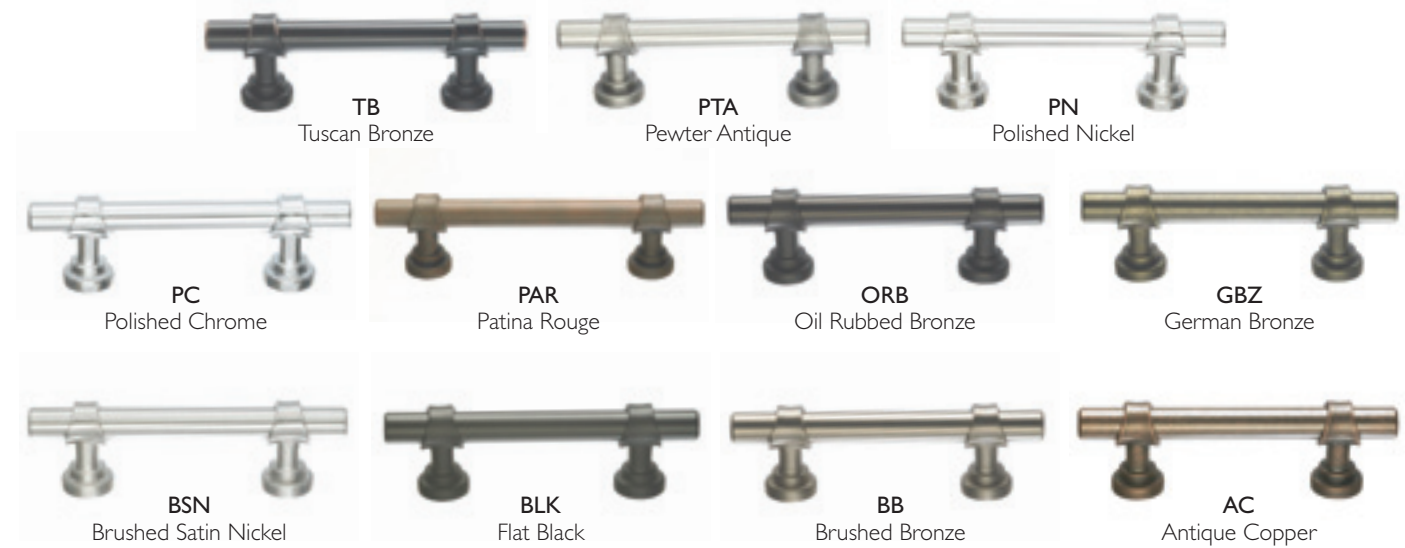

BLUR THE DISTINCTION
BETWEEN OLD WORLD STYLE AND
CONTEMPORARY DESIGN WITH
THESE STUNNING KNOBS AND
PULLS – BACKED BY A LIFETIME
WARRANTY.

MI240 on page 46

www.TopKnobs.com
 800-499-9095
 908-359-6174

Part Number is specific to shape and finish. cc = measurement center-to-center between the screw holes.

Lifetime Warranty for the original purchaser against defects in materials and craftsmanship.

Free Samples of any knob and of any pull less than 7", with a \$5 packaging and shipping charge each.

NOTE: For detailed dimensions such as overall length, height, base width, etc. see price list or visit TopKnobs.com.

KNOBS ~ 2 STYLES



M1227 - 1 5/16" Peak Knob
in Oil Rubbed Bronze



1 1/4" Bergen Knob
Patina Rouge



1 5/16" Peak Knob
Pewter Antique

Finish	Bergen 1 1/4"	Peak 1 5/16"
PTA	M1202	M1229
NEW PN	M1321	-
NEW PC	M1121	-
PAR	M1201	M1228
ORB	M1200	M1227
NEW BSN	M1119	-
BLK	M1120	-
NEW BB	M1605	-

PULLS ~ 2 SIZES

Finish	4" cc	3" cc
PTA	M1214	M1217
PAR	M1213	M1216
ORB	M1212	M1215

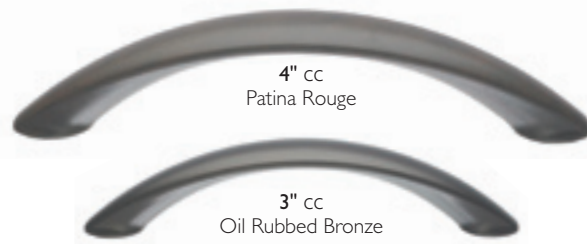

4" cc
Patina Rouge



3" cc
Oil Rubbed Bronze

PULLS ~ 3 SIZES



3" cc
Brushed Bronze



5 1/16" cc
Pewter Antique

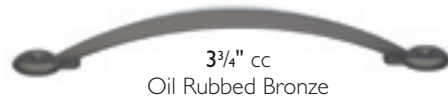

3 3/4" cc
Oil Rubbed Bronze

	NEW TB	PTA	NEW PN	NEW PC	PAR	ORB	NEW GBZ	NEW BSN	BLK	NEW BB	AC
3" cc	M1723	M1732	M1726	M1727	M1729	M1730	M1731	M1725	M1733	M1728	M1724
3 3/4" cc	M1661	M1238	-	-	M1237	M1236	-	-	-	M1662	-
5 1/16" cc	-	M1241	-	-	M1240	M1239	-	-	-	-	-

FINISHES AVAILABLE



PULLS ~ 3 SIZES

Finish	6" cc	4" cc	3" cc
PTA	M1187	M1190	M1193
NEW PN	M1278	M1280	M1282
PAR	M1186	M1189	M1192
ORB	M1185	M1188	M1191
NEW BSN	M1277	M1279	M1281



Pulls shown in
Oil Rubbed
Bronze

KNOBS & CUP PULL ~ 3 STYLES



M1232 - 1 3/8" Flat Top Knob in Pewter Antique



1 1/4"
Rounded Knob
Brushed Bronze



1 3/8"
Flat Top Knob
Oil Rubbed Bronze



2 5/16" cc
Cup Pull
Patina Rouge

	NEW TB	PTA	NEW PN	PAR	ORB	NEW BSN	NEW BB
1 1/4" Round	M1583	M1226	M1582	M1225	M1224	M1581	M1580
1 3/8" Flat Top	M1591	M1232	M1304	M1231	M1230	M1303	M1590
2 5/16" cc Pull Pull	-	M1211	M1301	M1210	M1209	M1300	-

PULLS ~ 3 STYLES



5 1/16" cc Saddle Pull
Patina Rouge



5 1/16" cc Buckle Pull
Oil Rubbed Bronze

	PTA	NEW PN	PAR	ORB	NEW BSN
5 1/16" cc Saddle Pull	M1220	-	M1219	M1218	-
5 1/16" cc Buckle Pull	M1205	M1267	M1204	M1203	M1266
3 3/4" cc Lida Pull	M1208	-	M1207	M1206	-



3 3/4" cc Lida Pull
Pewter Antique



WWW.TOPKNOBS.COM
800-499-9095
908-359-6174

NOTE: For detailed dimensions such as overall length, height, base width, etc. see price list or visit TopKnobs.com.

Part Number is specific to shape and finish. cc = measurement center-to-center between the screw holes.
Lifetime Warranty for the original purchaser against defects in materials and craftsmanship.
Free Samples of any knob and of any pull less than 7", with a \$5 packaging and shipping charge each.



ALWAYS THE PERFECT OPENING

Edwardian Collection

RIBBON & REED T-HANDLE & KNOB



M929 - 2 3/4" T-Handle in Pewter Antique



1 1/4"
Tuscan Bronze



2 3/4" T-Handle
German Bronze

Finish	Knob	T-Handle
TB	M1647	M1646
PTA	M941	M929
PC	M1618	-
ORB	M943	M931
GBZ	M942	M930
BSN	M1617	-



TB
Tuscan Bronze
NEW



PTA
Pewter
Antique



PC
Polished
Chrome
NEW



ORB
Oil Rubbed
Bronze



GBZ
German
Bronze
NEW



BSN
Brushed Satin
Nickel

RIBBON & REED PULLS ~ 4 STYLES



5 1/8" cc Drop Pull
German Bronze GBZ



3 3/4" cc D-Pull
Pewter Antique PTA



3" cc Cup Pull
Oil Rubbed Bronze ORB



3 3/4" cc Grace Pull
Polished Nickel PN

	PTA	NEW PN	PC	ORB	GBZ	NEW BSN
5 1/8" cc Drop Pull	M932	-	-	M934	M933	-
3 3/4" cc D-Pull	M935	-	-	M937	M936	-
3" cc Cup Pull	M938	-	-	M940	M939	-
3 3/4" cc Grace Pull	M926	M1260	M1623	M928	M927	M1259

DISCOVER A TWIST ON THE TRADITIONAL THAT WILL DELIGHT IN DECORATIVE DETAILS. OUR EDWARDIAN COLLECTION FEATURES DISTINCTIVE RIBBON & REED STYLING - ALL PROTECTED BY A LIFETIME WARRANTY.

M935 on page 49

 WWW.TOPKNOBS.COM
 800-499-9095
 908-359-6174

Part Number is specific to shape and finish. cc = measurement center-to-center between the screw holes.

Lifetime Warranty for the original purchaser against defects in materials and craftsmanship.

Free Samples of any knob and of any pull less than 7", with a \$5 packaging and shipping charge each.

NOTE: For detailed dimensions such as overall length, height, base width, etc. see price list or visit TopKnobs.com.

KNOBS ~ 4 STYLES



	NEW TB	PTA	NEW PC	ORB	GBZ	NEW BSN	NEW BB
1 5/16" Bead	–	M947	M1620	M949	M948	M1594	–
1 5/16" French	–	M953	–	M955	M954	–	–
1 5/16" Star	–	M950	–	M952	M951	–	–
1 1/8" Ribbon	M1644	M959	M1622	M961	M960	M1621	M1645

PULLS ~ 4 STYLES



	NEW TB	PTA	ORB	GBZ	NEW BB
3 3/4" cc Straight	M1640	M944	M946	M945	M1641
3 3/4" cc Bow	–	M923	M925	M924	–
3 3/4" cc Link	–	M968	M970	M969	–
3" cc Link	–	M971	M973	M972	–

KNOB & PULLS ~ 3 STYLES



	NEW TB	PTA	NEW PN	ORB	GBZ	NEW BSN	NEW BB
1 1/4"	M1592	M911	M1307	M913	M912	M1306	M1593
3 3/4" cc	M1637	M956	M1293	M958	M957	M1292	M1638
4" cc	M1658	M965	–	M967	M966	–	–
3" cc	–	M962	–	M964	M963	–	–

PULLS ~ 5 SIZES Matching Appliance Pulls - see page 82

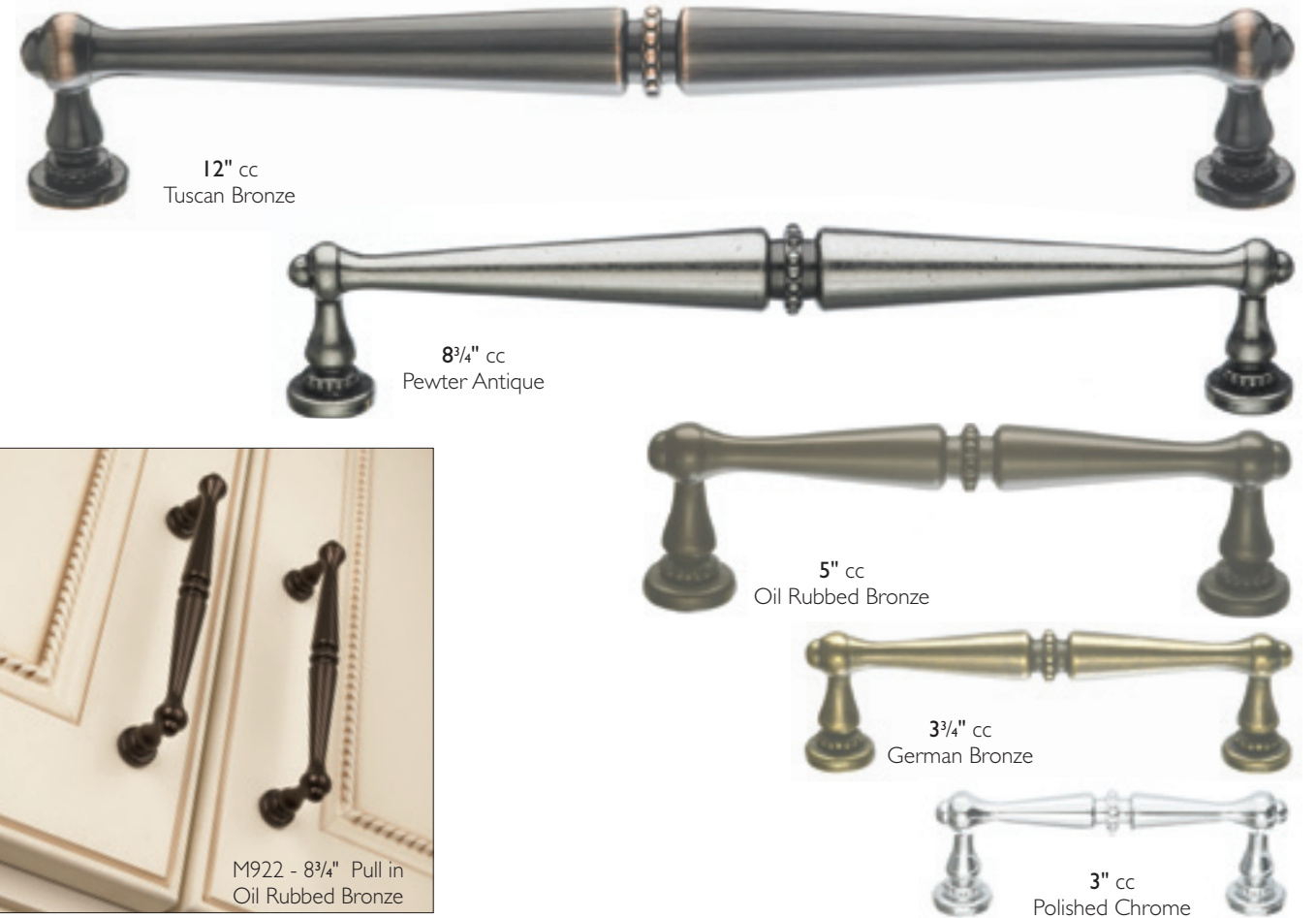

	TB	PTA	PN	PC	PAR	ORB	GBZ	BSN	BLK	BB	AC
NEW 12" cc	TK158TB	TK158PTA	–	–	–	TK158ORB	TK158GBZ	–	–	–	–
8 3/4" cc	–	M920	–	–	–	M922	M921	–	–	–	–
5" cc	–	M917	–	–	–	M919	M918	–	–	–	–
3 3/4" cc	–	M914	–	–	–	M916	M915	–	–	–	–
NEW 3" cc	M1712	M1721	M1715	M1716	M1718	M1719	M1720	M1714	M1722	M1717	M1713

FINISHES AVAILABLE



NOTE: For detailed dimensions such as overall length, height, base width, etc. see price list or visit TopKnobs.com.

Part Number is specific to shape and finish. cc = measurement center-to-center between the screw holes. Lifetime Warranty for the original purchaser against defects in materials and craftsmanship. Free Samples of any knob and of any pull less than 7", with a \$5 packaging and shipping charge each.



ALWAYS THE PERFECT OPENING



FREE YOUR SENSE OF STYLE WITH MIX-AND-MATCH BIRDCAGE AND TWISTED WIRE DESIGNS. FEATURING 138 PRODUCTS IN A VARIETY OF FINISHES, OUR NORMANDY COLLECTION ADDS A TIMELESS WARMTH TO ANY DÉCOR.

M639 on page 53

Normandy Collection

TWISTED WIRE PULLS ~ 4 STYLES Matching Appliance Pulls - see page 87

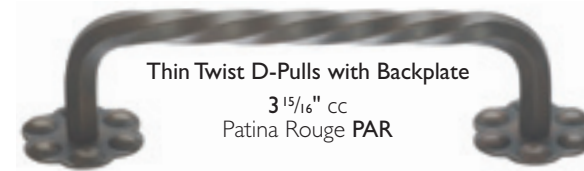

Thin Twist D-Pulls with Backplate
3 15/16" cc
Patina Rouge PAR



3 5/32" cc
Patina Rouge PAR

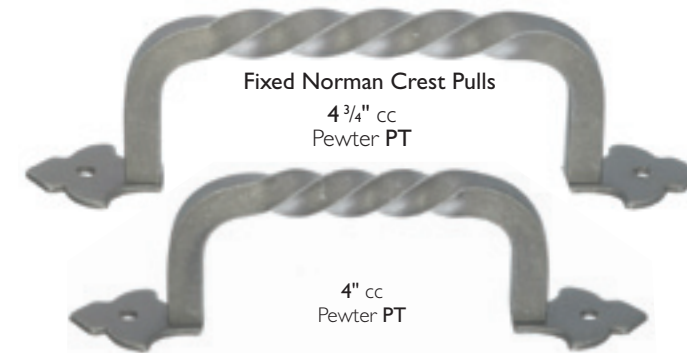

Fixed Norman Crest Pulls
4 3/4" cc
Pewter PT

4" cc
Pewter PT

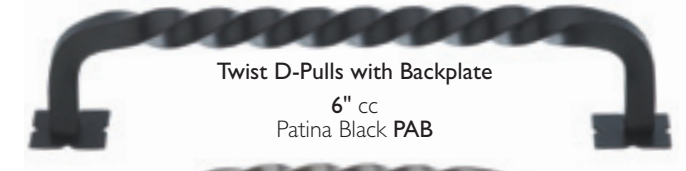

Twist D-Pulls with Backplate
6" cc
Patina Black PAB

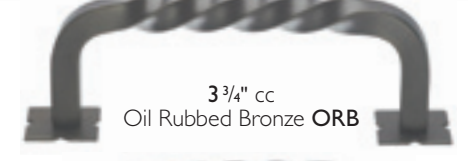

3 3/4" cc
Oil Rubbed Bronze ORB



3" cc
Patina Black PAB



Twist Drop Pull
3 3/4" cc
Pewter PT

Finish	Thin Twist D-Pulls with Backplate		Twist D-Pulls with Backplate			Fixed Norman Crest Pulls		Twist Drop Pull
	3 15/16" cc	3 5/32" cc	6" cc	3 3/4" cc	3" cc	4 3/4" cc	4" cc	3 3/4" cc
PT	M649	M646	M736	M712	M709	M694	M691	M643
PAR	M648	M645	M735	M711	M708	M693	M690	M642
PAB	M650	M647	M737	M713	M710	M695	M692	M644
NEW ORB	-	-	-	M784	M783	-	-	-

TWISTED T-HANDLE & RING PULLS ~ 3 STYLES



M738 - 3 3/16" Twisted T-Handle in Patina Rouge



3 3/16" Twisted T-Handle
Patina Rouge PAR



1 3/16" Patina Rouge PAR



1 9/16" Pewter PT



1 3/8" Twist Ring
Patina Black PAB

Finish	Twisted T-Handle	1 3/16" Ring	1 9/16" Ring	1 3/8" Twist Ring
PT	M739	M634	M637	M640
PAR	M738	M633	M636	M639
PAB	M740	M635	M638	M641



WWW.TOPKNOBS.COM
800-499-9095
908-359-6174

Part Number is specific to shape and finish. cc = measurement center-to-center between the screw holes.

Lifetime Warranty for the original purchaser against defects in materials and craftsmanship.

Free Samples of any knob and of any pull less than 7", with a \$5 packaging and shipping charge each.

NOTE: For detailed dimensions such as overall length, height, base width, etc. see price list or visit TopKnobs.com.

OVAL TWIST KNOBS ~ 3 SIZES



Finish	2 1/8" Small	3" Medium	3 1/4" Large
PT	M619	M622	M625
PAR	M618	M621	M624
PAB	M620	M623	M626
NEW ORB	M775	M779	-

ROUND & FLOWER TWIST KNOBS ~ 2 STYLES



Finish	1 1/4" Small	1 1/2" Large	1 1/4" Flower
PT	M613	M616	M610
PAR	M612	M615	M609
PAB	M614	M617	M611
NEW ORB	M777	M776	M778

TWISTED BAR PULLS ~ 3 SIZES



Finish	12" cc	8" cc	6" cc
PT	M676	M673	M670
PAR	M675	M672	M669
PAB	M677	M674	M671

Pulls shown in Patina Rouge

TWISTED WIRE DROP PULLS ~ 5 SIZES

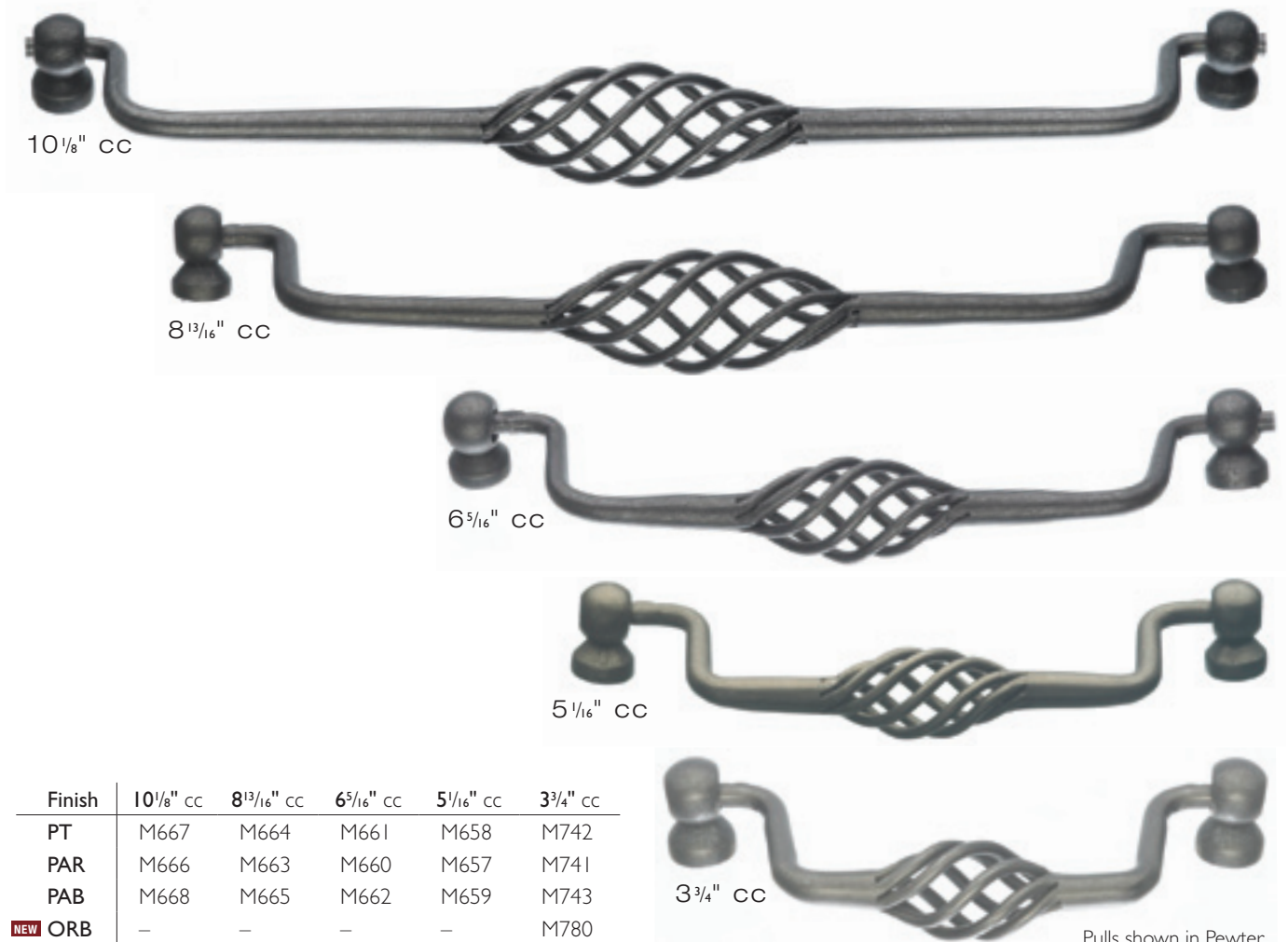

Finish	10 1/8" cc	8 13/16" cc	6 5/16" cc	5 1/16" cc	3 3/4" cc
PT	M667	M664	M661	M658	M742
PAR	M666	M663	M660	M657	M741
PAB	M668	M665	M662	M659	M743
NEW ORB	-	-	-	-	M780

Pulls shown in Pewter

TWISTED WIRE D-PULLS ~ 2 SIZES Matching Appliance Pulls - see page 86



Finish	6" cc	3 3/4" cc
PT	M655	M652
PAR	M654	M651
PAB	M656	M653
NEW ORB	M782	M781

Pulls shown in Patina Black



WWW.TOPKNOBS.COM
800-499-9095
908-359-6174

NOTE: For detailed dimensions such as overall length, height, base width, etc. see price list or visit TopKnobs.com.

Part Number is specific to shape and finish. cc = measurement center-to-center between the screw holes.
Lifetime Warranty for the original purchaser against defects in materials and craftsmanship.
Free Samples of any knob and of any pull less than 7", with a \$5 packaging and shipping charge each.

KNOBS ~ 7 STYLES



1 1/8" Step Oil Rubbed Bronze ORB
 1 1/8" Normandy Pewter PT
 1 1/4" Button Tuscan Bronze TB
 1 1/4" Ring Brushed Satin Nickel BSN
 1 1/4" Flower German Bronze GBZ



3 5/8" T - Shaped Twist Knob Patina Black PAB
 3 1/4" S - Shaped Knob Patina Rouge PAR

	NEW TB	NEW PTA	PT	NEW PN	PAR	PAB	NEW ORB	NEW GBZ	NEW BSN
Step	-	-	M604	-	M603	M605	M769	-	-
Normandy	M1668	-	M607	-	M606	M608	M773	-	-
Button	M1614	-	M595	M1312	M594	M596	M753	-	M281
Ring	-	-	M598	M1309	M597	M599	M774	-	M1308
Flower	-	M1598	M601	-	M600	M602	M772	M1597	M1599
Twist Knob	-	-	M628	-	M627	M629	-	-	-
S Knob	-	-	M631	-	M630	M632	-	-	-

MATCHING BACKPLATES ~ 4 STYLES



M606 & M702 - 1 1/8" Normandy Knob & 6 7/16" Knob Backplate in Patina Rouge



Pewter PT Patina Rouge PAR Patina Black PAB

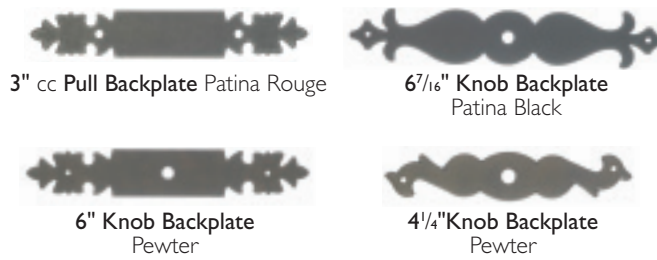

3" cc Pull Backplate Patina Rouge
 6 7/16" Knob Backplate Patina Black
 6" Knob Backplate Pewter
 4 1/4" Knob Backplate Pewter

Finish	Pull Backplate	Knob Backplates		
	3" cc	6"	6 7/16"	4 1/4"
PT	M697	M700	M703	M706
PAR	M696	M699	M702	M705
PAB	M698	M701	M704	M707

DROP PULLS ~ 4 SIZES



12" cc



10" cc



7" cc



3 3/4" cc

Pulls shown in Patina Rouge

Finish	12" cc	10" cc	7" cc	3 3/4" cc
PT	M685	M682	M679	M688
PAR	M684	M681	M678	M687
PAB	M686	M683	M680	M689

PULLS ~ 2 SIZES **Matching Appliance Pulls - see page 81**



4" cc

Pull shown in Patina Black



3" cc

Pull shown in Pewter

Finish	4" cc	3" cc
PT	M592	M589
PAR	M591	M588
PAB	M593	M590
NEW ORB	M792	M791

Part Number is specific to shape and finish. cc = measurement center-to-center between the screw holes.
Lifetime Warranty for the original purchaser against defects in materials and craftsmanship.
Free Samples of any knob and of any pull less than 7", with a \$5 packaging and shipping charge each.

NOTE: For detailed dimensions such as overall length, height, base width, etc. see price list or visit TopKnobs.com.



ALWAYS THE PERFECT OPENING



EMBRACE YOUR DESIRE FOR CONTEMPORARY STYLING WITH OUR NOUVEAU COLLECTION, WHICH CELEBRATES MODERN AND MINIMALISTIC TASTES – ALL WITH UNSURPASSED QUALITY AND AN EXCLUSIVE LIFETIME WARRANTY.

M1148 on page 67

Nouveau Collection

CUP PULLS ~ 2 STYLES

Finish	Cup Pull 1 1/4" cc	Eye-brow Cup Pull 2 1/2" cc
PC	M413	M415
BSN	M412	M414
BLK	M498	M416



1 1/4" cc Cup Pull
Brushed Satin Nickel



2 1/2" cc Eye-brow Cup Pull
Brushed Satin Nickel

PULLS ~ 2 STYLES



5 1/8" cc Curved Wire Pull
Polished Brass PB



5 1/8" cc Crescent Pull
Polished Chrome PC



3 3/4" cc Curved Wire Pull
Brushed Satin Nickel BSN



3 3/4" cc Crescent Pull
Polished Chrome PC



3" cc Crescent Pull
Polished Chrome PC

	NEW TB	NEW PTA	NEW PN	PC	PB	NEW PAR	NEW ORB	NEW GBZ	BSN	NEW BLK	NEW BB	NEW AC
5 1/8" cc Curved Wire	–	–	–	M427	M426	–	–	–	M428	–	–	–
3 3/4" cc Curved Wire	–	–	–	M425	M423	–	–	–	M424	–	–	–
5 1/8" cc Crescent	M1654	–	–	M397	–	–	–	–	M396	–	M1655	–
3 3/4" cc Crescent	–	–	–	M395	–	–	–	–	M394	–	–	–
NEW 3" cc Crescent	M1734	M1743	M1737	M1738	–	M1740	M1741	M1742	M1736	M1744	M1739	M1735

FINISHES AVAILABLE



www.TOPKNOBS.COM
800-499-9095
908-359-6174

Part Number is specific to shape and finish. cc = measurement center-to-center between the screw holes.
Lifetime Warranty for the original purchaser against defects in materials and craftsmanship.
Free Samples of any knob and of any pull less than 7", with a \$5 packaging and shipping charge each.
NOTE: For detailed dimensions such as overall length, height, base width, etc. see price list or visit TopKnobs.com.

KNOBS ~ 4 STYLES



M371 - 1 1/16" Cone Knob in Brushed Satin Nickel



	NEW						
	TB	PC	PN	ORB	BSN	BLK	BB
1 1/16" Cone	M1676	M372	M1322	M1602	M371	M373	M1677
1 1/8" Knob	-	M377	-	-	M376	M378	-
1 1/4" Mushroom	-	M411	-	-	M410	-	-
1 1/2" Oval	-	M380	-	-	M379	M499	-

PULLS ~ 2 SIZES



5 3/16" cc Brushed Satin Nickel



3 3/4" cc Flat Black

Finish	5 3/16" cc	3 3/4" cc
PN	M1264	M1330
PC	M382	M385
BSN	M381	M384
BLK	M383	M386

PULLS ~ 3 STYLES



5 1/16" cc Mandal Polished Chrome

5 1/16" cc Honeyman Brushed Satin Nickel



5 1/16" cc Wave Polished Chrome

Finish	5 1/16" cc Mandal	5 1/16" cc Honeyman	5 1/16" cc Wave
PC	M388	M420	M418
BSN	M387	M419	M417

PULLS ~ 2 STYLES Matching Appliance Pulls - see page 82



TKI47PC - 12" cc Verona Appliance Pull in Polished Chrome



5 1/16" cc Verona Pull Polished Chrome

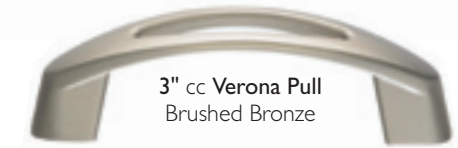

3" cc Verona Pull Brushed Bronze



5 1/16" cc Griggs Pull Flat Black



3" cc Griggs Pull Flat Black

	NEW											
	TB	PTA	PN	PC	PAR	ORB	GBZ	BSN	BLK	BB	AC	
5 1/16" cc Verona	-	-	-	M390	-	-	-	M389	-	-	-	
3" cc Verona	M1767	M1776	M1770	M1771	M1773	M1774	M1775	M1769	M1777	M1772	M1768	
5 1/16" cc Griggs	M1652	-	M1268	M392	-	-	-	M391	M393	M1653	-	
NEW 3" cc Griggs	M1701	M1710	M1704	M1705	M1707	M1708	M1709	M1703	M1711	M1706	M1702	

FINISHES AVAILABLE



NOTE: For detailed dimensions such as overall length, height, base width, etc. see price list or visit TopKnobs.com.

Part Number is specific to shape and finish. cc = measurement center-to-center between the screw holes. Lifetime Warranty for the original purchaser against defects in materials and craftsmanship. Free Samples of any knob and of any pull less than 7", with a \$5 packaging and shipping charge each.

PULLS ~ 3 SIZES

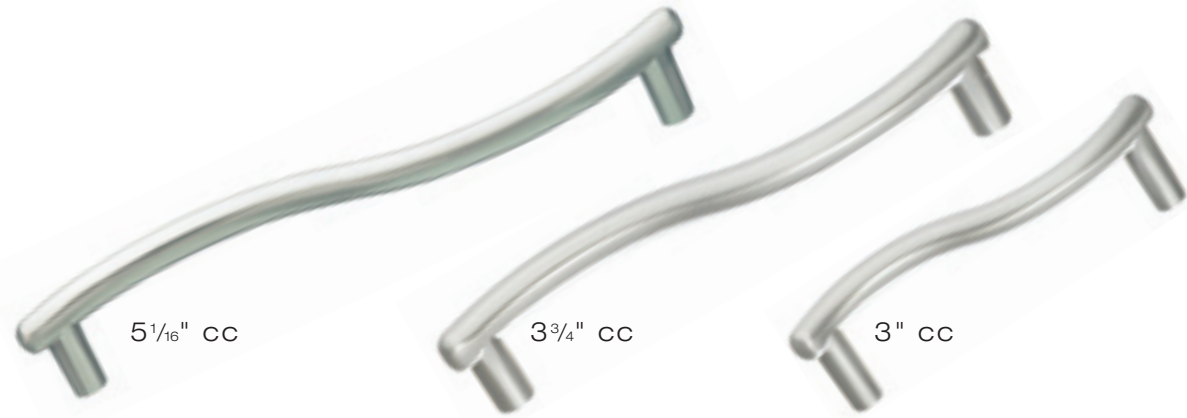

Pulls shown in Brushed Satin Nickel

	TB	PTA	PN	PC	PAR	ORB	GBZ	BSN	BLK	BB	AC
5 1/16" cc	-	-	-	M507	-	-	-	M506	M508	-	-
3 3/4" cc	-	-	-	M510	-	-	-	M509	M511	-	-
NEW 3" cc	M1756	M1765	M1759	M1760	M1762	M1763	M1764	M1758	M1766	M1761	M1757

FINISHES AVAILABLE



PULLS ~ 2 SIZES Matching Appliance Pulls - see page 82



M535 - 6 5/16" cc Pull in Flat Black

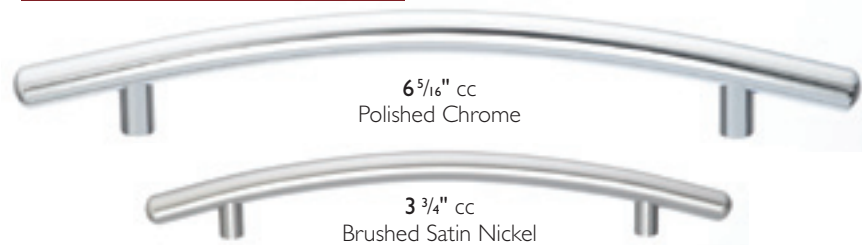

	PC	BSN	BLK
6 5/16" cc	M537	M536	M539
3 3/4" cc	M533	M534	M535

Nouveau II Collection

KNOBS & PULLS ~ 6 STYLES



Finish	5/8" Knob	7/8" Knob	1 3/16" Knob	3/4" cc Pull	5/8" cc Ring Pull	5/8" cc Pull
NEW PN	-	M1606	-	-	-	-
PC	M577	M550	M586	M556	M559	M522
BSN	M576	M549	M585	M555	M558	M521
BLK	M578	M551	M587	M557	M560	M523
NEW BB	-	M1607	-	-	-	-

PULLS ~ 2 STYLES



Finish	5 1/16" cc Hartford	3 3/4" cc Hartford	5 1/16" cc New Haven	3 3/4" cc New Haven
PC	M528	M524	M519	M516
BSN	M527	M526	M518	M515
BLK	M529	M525	M520	M517

PULLS ~ 3 STYLES



Finish	3 3/4" cc Trunk	5 1/16" cc	3 3/4" cc	5 1/16" cc Flute
NEW PN	M1261	-	-	-
PC	M531	M571	M568	M504
BSN	M530	M570	M567	M503
BLK	M532	M572	M569	M505

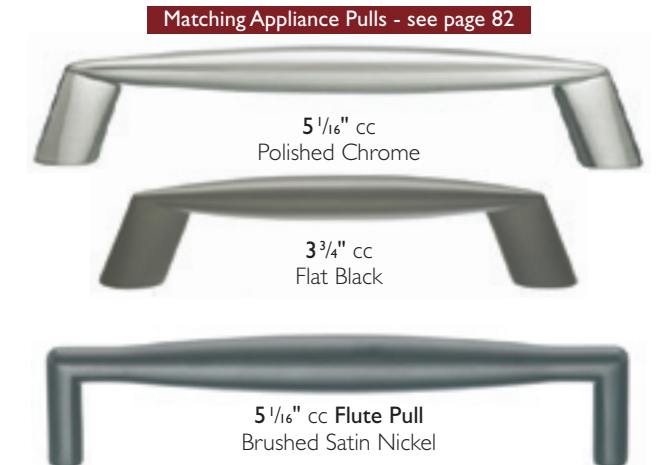

Matching Appliance Pulls - see page 82



NOTE: For detailed dimensions such as overall length, height, base width, etc. see price list or visit TopKnobs.com.

Part Number is specific to shape and finish. cc = measurement center-to-center between the screw holes. **Lifetime Warranty** for the original purchaser against defects in materials and craftsmanship. **Free Samples** of any knob and of any pull less than 7", with a \$5 packaging and shipping charge each.

PULLS ~ 3 STYLES



Finish	3 3/4" cc	2 1/2" cc	5 1/16" cc	3 3/4" cc	1 1/4" cc
PC	M562	M565	M544	M540	M547
BSN	M561	M564	M543	M541	M546
BLK	M563	M566	M545	M542	M548

KNOB & PULLS ~ 2 STYLES



Finish	1 1/4" cc	5 1/16" cc	Newport
PC	M553	M574	M513
BSN	M552	M573	M512
BLK	M554	M575	M514

KNOBS ~ 3 STYLES



	3/4" Polished Chrome	1" Brushed Satin Nickel	1" cc Infinity Knob Brushed Satin Nickel
3/4"	M1600	M580	M1601
1"	-	M583	M582
1" cc Infinity	-	M1127	M1125

NOTE: For detailed dimensions such as overall length, height, base width, etc. see price list or visit TopKnobs.com.

Nouveau III Collection

KNOBS ~ 3 STYLES



	NEW PTA	NEW PN	PC	PAR	ORB	NEW BSN	BLK	NEW BB
1 1/4"	M1202	M1321	M1121	M1201	M1200	M1119	M1120	M1605
1 3/16"	-	-	M1124	-	-	M1122	M1123	-
1 1/8"	-	-	M1118	-	-	M1116	M1117	-

FINISHES AVAILABLE



BAR PULLS ~ 3 STYLES



Finish	Tapered Bar		Hidra Bar		Mandal Bar
	6 5/16" cc	5 1/16" cc	5 1/16" cc	3 3/4" cc	5 1/16" cc
PC	M1172	M1175	M1133	M1130	M1181
BSN	M1170	M1173	M1131	M1128	M1179
BLK	M1171	M1174	M1132	M1129	M1180

Part Number is specific to shape and finish. cc = measurement center-to-center between the screw holes. Lifetime Warranty for the original purchaser against defects in materials and craftsmanship. Free Samples of any knob and of any pull less than 7", with a \$5 packaging and shipping charge each.

SQUARE BAR PULL ~ 5 SIZES Matching Appliance Pulls - see page 82



	TB	PN	PC	BSN	BLK	BB
NEW 12\"/>						
8 13/16\"/>						
6 5/16\"/>						
5 1/16\"/>						
3 3/4\"/>						

*Available January 2011.

SQUARE KNOBS ~ 7 FINISHES



	TB	PTA	PN	PC	BSN	BLK	BB
	Tuscan Bronze	Pewter Antique	Polished Nickel	Polished Chrome	Brushed Satin Nickel	Flat Black	Brushed Bronze
	NEW	NEW	NEW				NEW
Square Knob	M1588	M1589	M1320	M1166	M1164	M1165	M1587

Nouveau III Collection

GROOVED PULLS ~ 2 SIZES

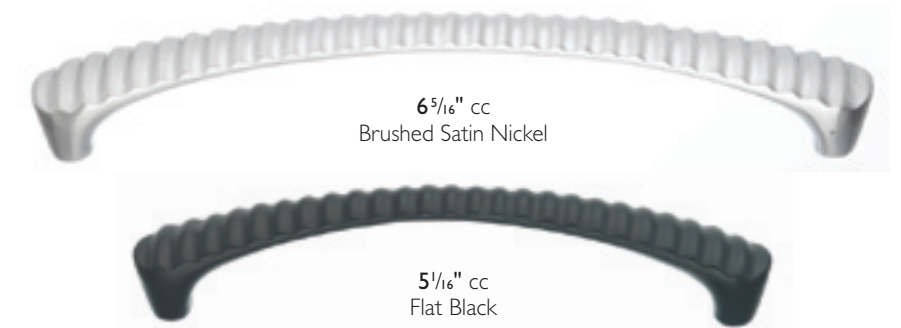

Finish	6 5/16\"/>	
PC	M1139	M1136
BSN	M1137	M1134
BLK	M1138	M1135

PULLS ~ 2 SIZES

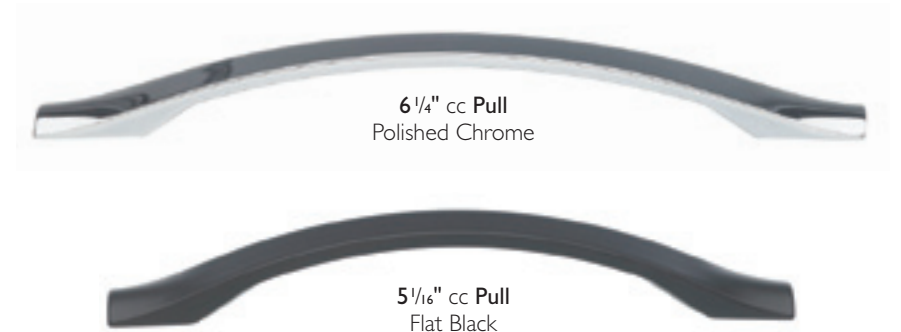

Finish	6 1/4\"/>	
PC	M1151	M1178
BSN	M1149	M1176
BLK	M1150	M1177

PULLS ~ 4 STYLES



Finish	Boro Pull 5 1/16\"/>	Tinley Pull 5 1/16\"/>	Twist Pull 5 1/16\"/>	Crescent Flair Pull 5 1/16\"/>
TB	-	-	-	M1656
PC	M1142	M1184	M1145	M1148
BSN	M1140	M1182	M1143	M1146
BLK	M1141	M1183	M1144	M1147
BB	-	-	-	M1657



NOTE: For detailed dimensions such as overall length, height, base width, etc. see price list or visit TopKnobs.com.

Part Number is specific to shape and finish. cc = measurement center-to-center between the screw holes. Lifetime Warranty for the original purchaser against defects in materials and craftsmanship. Free Samples of any knob and of any pull less than 7", with a \$5 packaging and shipping charge each.

KNOBS ~ 15 STYLES



1 1/4" Flower M772 1 3/8" Knob M793 1 1/4" Empress M768 1 1/4" Swirl Cut M770 1 1/4" Button Faced M755 1 1/4" Melon Cut M756 1 1/4" Oval Rope M751

BAR PULLS ~ 11 SIZES Matching Appliance Pulls - see page 83

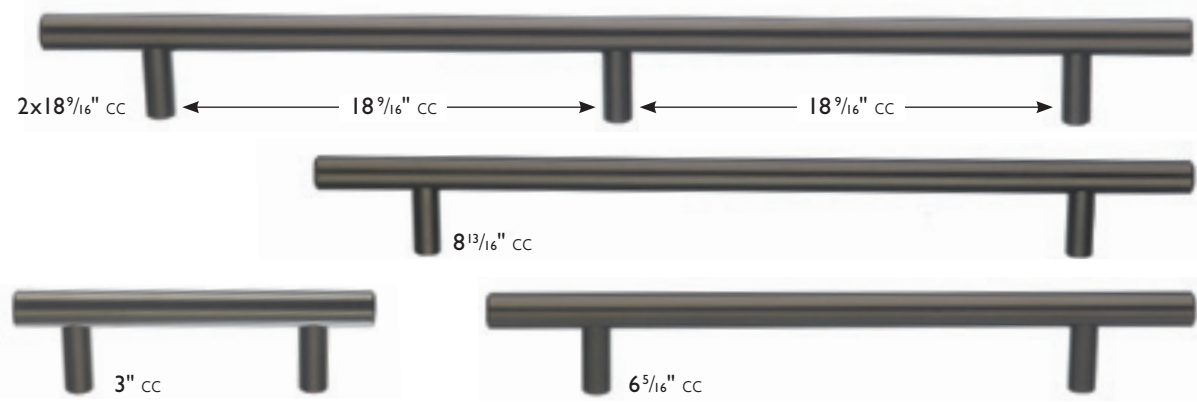

2x18 9/16" cc (36 3/4") M764a 30 1/4" cc M764 26 15/32" cc M763 18 7/8" cc M762 15" cc M761a 11 11/32" cc M761 8 13/16" cc M760 6 5/16" cc M759 5 1/16" cc M758 3 3/4" cc M757 3" cc M757a

TWISTED KNOBS & PULLS ~ 5 STYLES

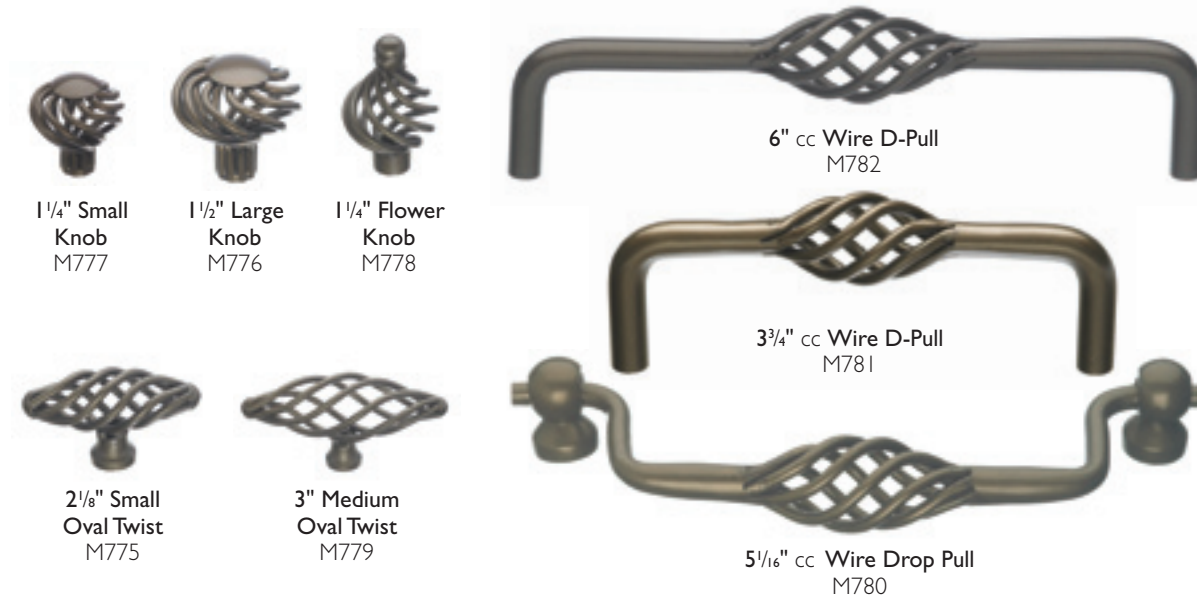

1 1/4" Small Knob M777 1 1/2" Large Knob M776 1 1/4" Flower Knob M778
 2 1/8" Small Oval Twist M775 3" Medium Oval Twist M779

6" cc Wire D-Pull M782
 3 3/4" cc Wire D-Pull M781
 5 1/16" cc Wire Drop Pull M780

NOTE: For detailed dimensions such as overall length, height, base width, etc. see price list or visit TopKnobs.com.



1 1/8" Step M769 1 1/4" Ascot M771 1 1/4" Normandy M773 1 1/4" Ring M774 1 1/4" Egg M750 1 1/4" Ray M752 1 1/4" Mushroom M753 1 1/4" Flat-Faced M754

PULLS ~ 13 STYLES



3 1/2" cc Somerset D-Pull M746 4" cc Normandy D-Pull M792 3 3/4" cc Pull M766
 3" cc Somerset D-Pull M747 3" cc Normandy D-Pull M791 3" cc Pull M767
 4" cc Wire Pull M748 3" cc Cup Pull M744 3 3/4" cc Twist D-Pull with Backplates M784
 3" cc Wire Pull M749 2 1/2" cc Cup Pull M745 3" cc Twist D-Pull with Backplates M783
 3 3/4" cc Asbury D-Pull M789 5 1/16" cc Twisted Bar Pull M790 4" cc Drop Pull M786
 3 3/4" cc Nouveau Bamboo D-Pull M788 3" cc Rope D-Pull M787 3" cc D-Pull with Backplates M785

Part Number is specific to shape and finish. cc = measurement center-to-center between the screw holes.
Lifetime Warranty for the original purchaser against defects in materials and craftsmanship.
Free Samples of any knob and of any pull less than 7", with a \$5 packaging and shipping charge each.



ALWAYS THE PERFECT OPENING



OUR SOMERSET COLLECTION CREATES A SEAMLESS TRANSITION BETWEEN CLASSIC AND CONTEMPORARY. INDULGE IN TRADITIONAL SOLID BRASS STYLING FINISHED WITH CONTEMPORARY FLAIR. AVAILABLE IN THIRTEEN COMPLEMENTARY FINISHES.

M292 on page 72

Somerset Collection

KNOBS ~ 3 STYLES



M270 - 1 1/4" Flat Faced Knob in Polished Chrome



M349 - 1 1/4" Ray Knob in Polished Brass



M281 - 1 1/4" Mushroom Knob in Brushed Satin Nickel

	VDG	NEW TB	RST	PTA	PC	PB	ORB	GBZ	BSN	BNI	BLK	BI	NEW BB	AC
Flat	M274	-	M277	M275	M270	M269	M754	M276	M271	M272	-	M273	-	M278
Ray	M352	-	M356	M354	M350	M349	M752	M355	M351	-	-	M353	-	M357
Mushroom	M284	M1614	M288	M286	M280	M279	-	M287	M281	M282	M285	M283	M1603	M289

FINISHES AVAILABLE



PULLS ~ 2 SIZES



3" cc Somerset Verdigris



3 1/2" cc Somerset Pewter Antique

	VDG	NEW TB	RST	PTA	PC	PB	GBZ	BSN	BNI	BI	BLK	NEW BB	AC
3" cc	M304	M1672	M307	M305	M299	M298	M306	M300	M302	M301	M303	M1673	M308
3 1/2" cc	M315	-	M318	M316	M310	M309	M317	M311	M313	M312	M314	-	M319



WWW.TOPKNOBS.COM
800-499-9095
908-359-6174

Part Number is specific to shape and finish. cc = measurement center-to-center between the screw holes.

Lifetime Warranty for the original purchaser against defects in materials and craftsmanship.

Free Samples of any knob and of any pull less than 7", with a \$5 packaging and shipping charge each.

NOTE: For detailed dimensions such as overall length, height, base width, etc. see price list or visit TopKnobs.com.



M328 - 1 1/4" Swirl Cut Knob in Verdigris

KNOBS ~ 3 STYLES



1 1/4" Hollow Round Knob
Polished Brass PB



1 1/4" Oval
Rope Knob
Antique Copper AC



1 3/16" Swirl
Cut Knob
Verdigris VDG

	NEW VDG	TB	RST	PTA	PN	PC	PB	ORB	GBZ	BSN	BI	NEW BB	AC
Round	-	-	-	-	-	M344	M343	-	-	M345	-	-	-
Rope	-	-	M403	M401	-	M1624	M346	M751	M402	M347	M348	-	M404
Swirl	M328	M1586	M331	M329	M1585	M325	M324	M770	M330	M326	M327	M1584	M332



M323 - 1 1/4" Melon Knob in
Antique Copper

KNOBS ~ 3 STYLES



1 1/4" Egg Knob
Black Iron BI



1 1/4" Button Faced Knob
Brushed Satin Nickel BSN



1 1/4" Melon Knob
German Bronze GBZ

	NEW TB	RST	NEW PTA	NEW PN	PC	PB	ORB	OEC	GBZ	NEW BSN	BI	AC
Egg	-	M203	M202	M1305	M369	M368	M750	M986	M204	M370	M405	M205
Button	-	M296	M294	M1325	M291	M290	M755	-	M295	M292	M293	M297
Melon	M1616	M322	M1596	M1319	M1615	M320	M756	-	M321	M1318	-	M323

PULLS ~ 2 STYLES



5 1/16" cc Voss
Antique Copper



5 1/16" cc Star
Pewter Antique



3 3/4" cc Voss
Antique Copper



3 3/4" cc Star
Pewter Antique

	NEW TB	RST	PTA	PT	NEW PN	GBZ	NEW BSN	NEW BB	AC
5 1/16" cc Voss	-	M480	M479	-	M1297	M482	M1296	-	M481
3 3/4" cc Voss	M1642	M484	M483	-	M1327	M486	M1326	M1643	M485
5 1/16" cc Star	-	M488	-	M487	-	M490	-	-	M489
3 3/4" cc Star	-	M492	-	M491	-	M494	-	-	M493

ARENDAL PULLS ~ 3 SIZES

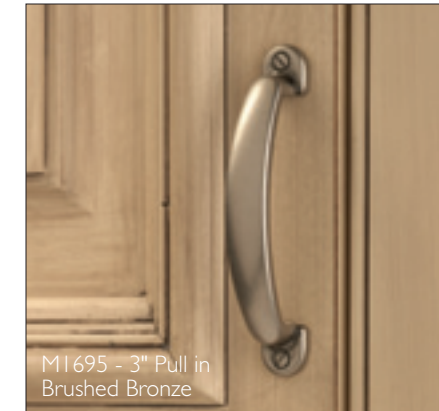

M1695 - 3" Pull in
Brushed Bronze

5 1/16" cc
Pewter Antique



3 3/4" cc
Rust



3" cc
German Bronze



	NEW TB	RST	PTA	PN	PC	PAR	ORB	GBZ	BSN	BLK	NEW BB	AC
5 1/16"	-	M472	M471	M1329	-	-	-	M474	M1328	-	-	M473
3 3/4"	-	M476	M475	M1295	-	-	-	M478	M1294	-	-	M477
NEW 3"	M1690	-	M1699	M1693	M1694	M1696	M1697	M1698	M1692	M1700	M1695	M1691

FINISHES AVAILABLE



TB
Tuscan Bronze



RST
Rust



PTA
Pewter Antique



PN
Polished Nickel



PC
Polished Chrome



PAR
Patina Rouge



ORB
Oil Rubbed Bronze



GBZ
German Bronze



BSN
Brushed Satin Nickel



BLK
Flat Black



BB
Brushed Bronze



AC
Antique Copper



CUP PULLS ~ 2 STYLES



2 1/2" cc
Polished Nickel PN



3" cc
Flat Black BLK

	VDG	NEW TB	RST	PTA	PN	PC	PB	NEW ORB	GBZ	BSN	BNI	BLK	BI	NEW BB	AC
2 1/2" cc	M408	M1659	M496	M409	M1302	M399	M398	M745	M495	M400	M407	-	M406	M1660	M497
3" cc	M361	M1674	M366	M364	-	M359	M358	M744	M365	M360	-	M362	M363	M1675	M367

FINISHES AVAILABLE

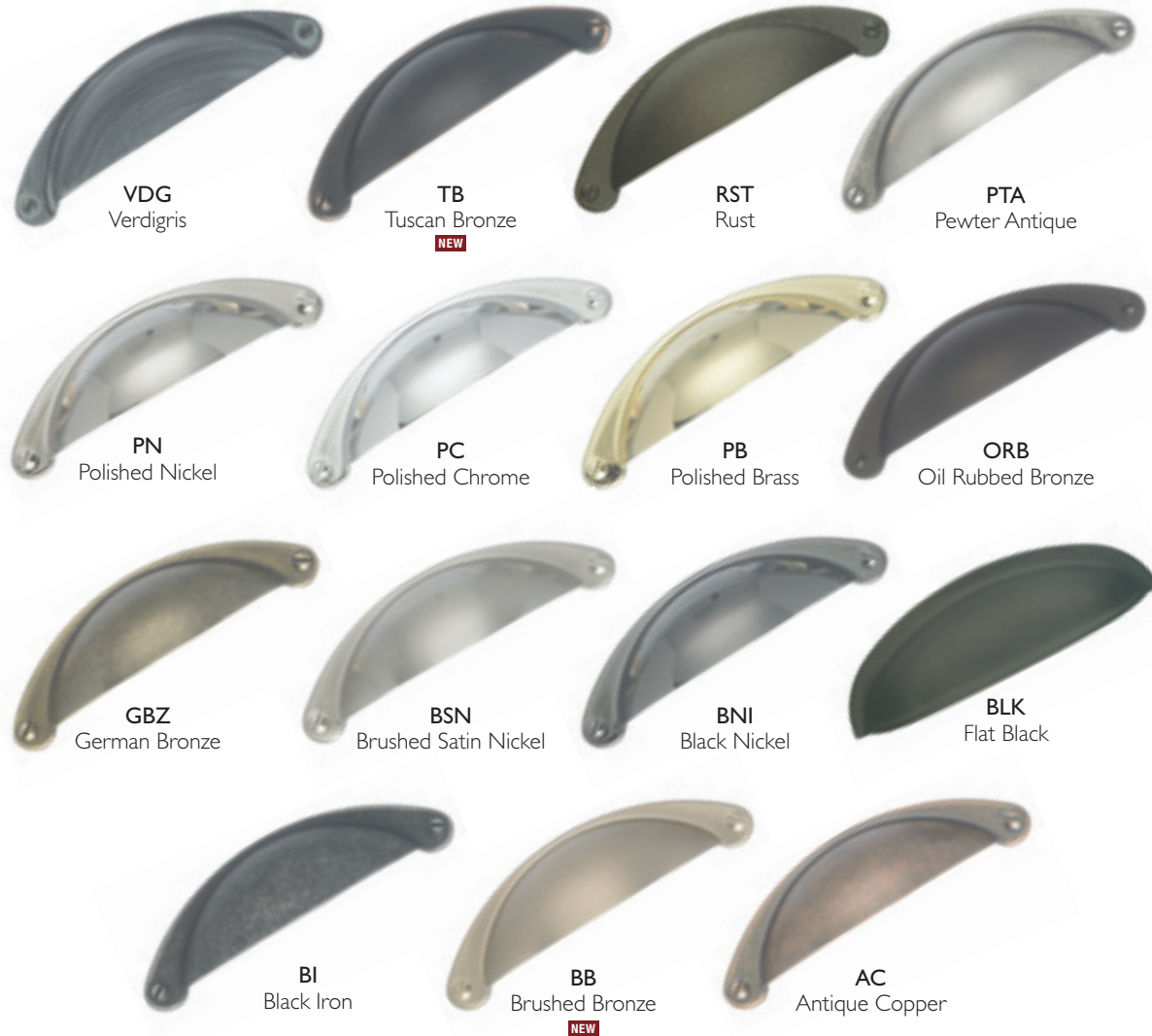

SPLIT FINISH PULL & KNOBS ~ 4 STYLES



1 1/4" Split Finish
Polished Nickel &
Polished Brass PN/PB



1 1/4" Split Finish
Brushed Satin Nickel &
Polished Brass BSN/PB



1 1/4" Ceramic
Brushed Satin Nickel BSN



1 1/4" Ceramic
Polished Chrome PC



1"
Brushed Satin Nickel &
Polished Brass BSN/PB



4" cc
Brushed Satin Nickel & Polished Brass BSN/PB



1"
Brushed Satin Nickel &
Polished Chrome BSN/PC



4" cc
Brushed Satin Nickel & Polished Chrome BSN/PC

	PN/PB	BSN	PC	BSN/PB	BSN/PC
1 1/4" Split Finish	M340	-	-	M339	-
1 1/4" Ceramic	-	M422	M421	-	-
1" Knob	-	-	-	M341	M342
4" Pull	-	-	-	M374	M375

WIRE PULLS ~ 2 SIZES



3" cc
Brushed Satin Nickel



4" cc
Brushed Satin Nickel

	PC	PB	BSN
3" cc	M334	M333	M335
4" cc	M337	M336	M338





ALWAYS THE PERFECT OPENING



INSPIRED BY THE CLASSIC ARCHITECTURAL DETAILS OF ITALIAN VILLAS, OUR TUSCANY COLLECTION BRINGS OLD WORLD CHARM TO THE HEART OF YOUR KITCHEN.

AVAILABLE IN TEN DISTINCTIVE FINISHES.

M178 & M173 on page 79

Tuscany Collection

TUSCANY PULLS & T-HANDLE ~ 3 STYLES Matching Appliance Pulls - see page 89



	NEW TB	RST	PTA	PTL	ORB	OEC	GBZ	DAB	NEW BSN	NEW BB
Small T-Handle	M1635	M149	M148	M152	M1339	M227	M150	M151	M1595	M1636
Large T-Handle	M1633	M154	M153	M157	M1334	M228	M155	M156	M1787	M1634
Large Drop Pull	M1625	M139	M138	M142	M1337	M218	M140	M141	M1790	M1626
Small Drop Pull	M1627	M134	M133	M137	M1336	M217	M135	M136	M1789	M1628
Large D-Pull	M1629	M466	M465	M470	M1338	M469	M468	M467	M1791	M1630
Small D-Pull	M1631	M144	M143	M147	M1335	M229	M145	M146	M1788	M1632

FINISHES AVAILABLE



www.TopKnobs.com
800-499-9095
908-359-6174

Part Number is specific to shape and finish. cc = measurement center-to-center between the screw holes.
Lifetime Warranty for the original purchaser against defects in materials and craftsmanship.
Free Samples of any knob and of any pull less than 7", with a \$5 packaging and shipping charge each.
NOTE: For detailed dimensions such as overall length, height, base width, etc. see price list or visit TopKnobs.com.

CELTIC KNOBS & MATCHING BACKPLATE ~ 2 STYLES

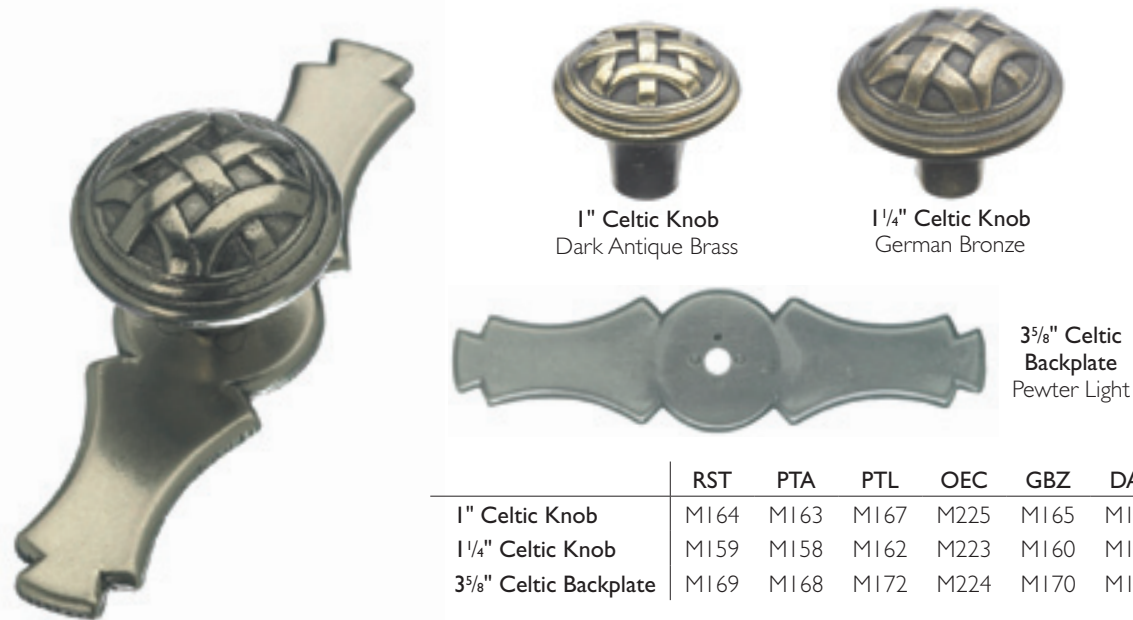

1" Celtic Knob
Dark Antique Brass

1 1/4" Celtic Knob
German Bronze

3 5/8" Celtic
Backplate
Pewter Light

	RST	PTA	PTL	OEC	GBZ	DAB
1" Celtic Knob	M164	M163	M167	M225	M165	M166
1 1/4" Celtic Knob	M159	M158	M162	M223	M160	M161
3 5/8" Celtic Backplate	M169	M168	M172	M224	M170	M171

M160 & M170 -
1 1/4" Celtic Knob with
Celtic Backplate shown
in German Bronze



RST
Rust

PTA
Pewter
Antique

PTL
Pewter
Light

OEC
Old English
Copper

GBZ
German
Bronze

DAB
Dark Antique
Brass

NOTE: Backplate sold separately.

DOVER PULLS & MATCHING BACKPLATE ~ 3 STYLES

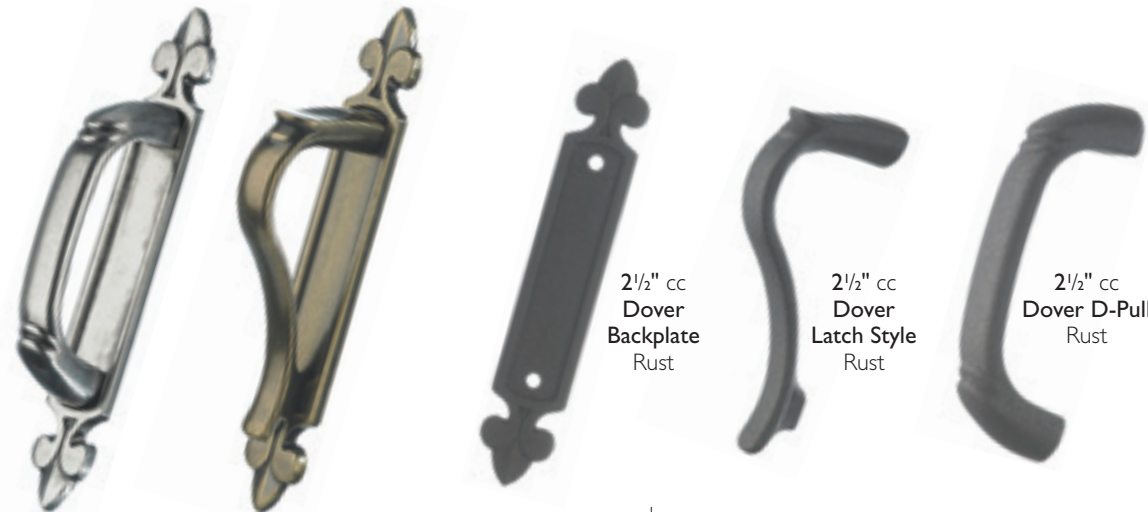

2 1/2" cc
Dover
Backplate
Rust

2 1/2" cc
Dover
Latch Style
Rust

2 1/2" cc
Dover D-Pull
Rust

	RST	PTA	PTL	OEC	GBZ	DAB
M188 & M193 - Dover D-Pull with Dover Backplate in Pewter Antique	M194	M193	M197	M221	M195	M196
M185 & M195 - Dover Latch Style with Dover Backplate in German Bronze	M184	M183	M187	M226	M185	M186
2 1/2" cc Dover Backplate	M189	M188	M192	M219	M190	M191
2 1/2" cc Dover Latch						
2 1/2" cc Dover D-Pull						

NOTE: Backplate sold separately.

NOTE: For detailed dimensions such as overall length, height,
base width, etc. see price list or visit TopKnobs.com.

KNOBS ~ 3 STYLES



M198 - 1 1/4" Contessa
Knob in Pewter Antique



1 1/4" Contessa Knob
German Bronze GBZ



1 1/4" Cumberland Knob
Rust RST



1 1/4" Worden Egg Knob
Antique Copper AC

	RST	PTA	PN	PC	PB	ORB	OEC	GBZ	BSN	BI	AC
1 1/4" Contessa Knob	M199	M198	-	-	-	-	M201	M200	-	-	-
1 1/4" Cumberland Knob	M207	M206	-	-	-	-	M209	M208	-	-	-
1 1/4" Worden Knob	M203	M202	M1305	M369	M368	M750	M986	M204	M370	M405	M205

NEWTON RING PULL & MATCHING BACKPLATE



3 3/16" Newton Backplate
German Bronze



M180 & M175 - 3 3/16" Newton
Backplate & 1 1/2" Newton Ring Pull Knob in German Bronze



1 1/2" Newton Ring Pull
German Bronze

	RST	PTA	PTL	OEC	GBZ	DAB
3 3/16" Backplate	M179	M178	M182	M222	M180	M181
1 1/2" Ring Pull	M174	M173	M177	M220	M175	M176

NOTE: Backplate sold separately.

PULLS ~ 2 STYLES



3 3/4" cc Salisbury Pull
Pewter Antique



3 3/4" w Mayfair Cup Pull
Old English Copper

	RST	PTA	OEC	GBZ
3 3/4" cc Salisbury Pull	-	M214	-	-
3 3/4" w Mayfair Cup Pull	M211	M210	M213	M212

Part Number is specific to shape and finish. cc = measurement center-to-center between the screw holes.
Lifetime Warranty for the original purchaser against defects in materials and craftsmanship.
Free Samples of any knob and of any pull less than 7", with a \$5 packaging and shipping charge each.



ALWAYS THE PERFECT OPENING

BEAUTY BEYOND JUST THE CABINETS –
 CUSTOMIZE THE APPEARANCE OF YOUR
 APPLIANCES WITH OUR ELEGANT YET
 DURABLE MATCHING APPLIANCE PULLS.
 WITH 17 FINISHES, 24 STYLES AND
 8 LENGTHS, YOU’RE ONLY LIMITED
 BY YOUR IMAGINATION.

Appliance Pull Collection

NORMANDY PULLS ~ 5 SIZES

Matching Cabinet pulls shown on page 57

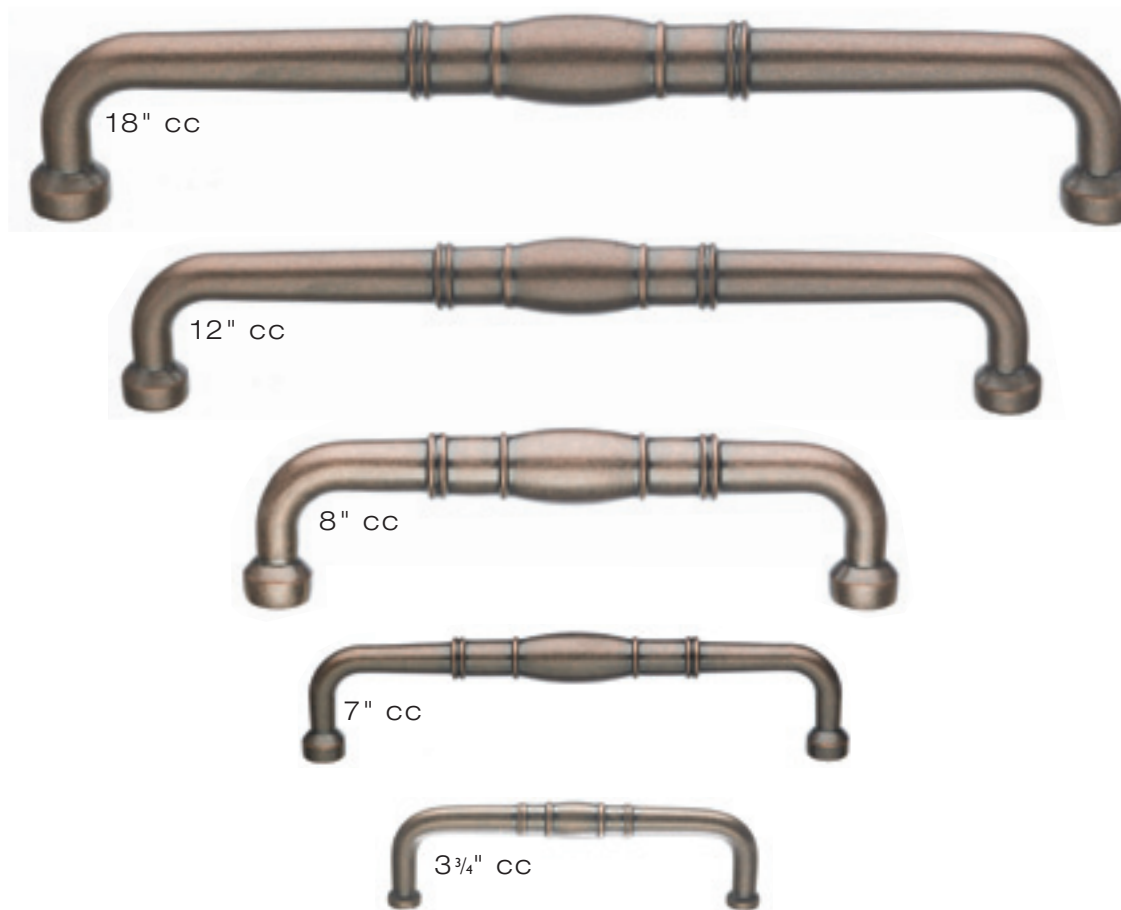

NEW TB
Tuscan Bronze



RST
Rust



PTA
Pewter Antique



PT
Pewter



NEW PN
Polished Nickel



PC
Polished Chrome

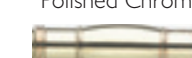

PB
Polished Brass

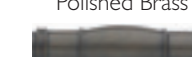

PAR
Patina Rouge

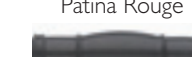

PAB
Patina Black



ORB
Oil Rubbed
Bronze



OEC
Old English
Copper

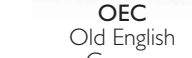

GBZ
German Bronze

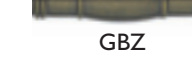

BSN
Brushed Satin
Nickel

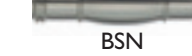

AC
Antique Copper

Finish	3 1/4" cc	7" cc	8" cc	12" cc	18" cc
NEW TB	M1798-96	M1798-7	M1798-8	M1798-12	M1798-18
RST	M842-96	M842-7	M842-8	M842-12	M842-18
PTA	M845-96	M845-7	M845-8	M845-12	M845-18
PT	M848-96	M848-7	M848-8	M848-12	M848-18
NEW PN	M1800-96	M1800-7	M1800-8	M1800-12	M1800-18
PC	M839-96	M839-7	M839-8	M839-12	M839-18
PB	M840-96	M840-7	M840-8	M840-12	M840-18
PAR	M846-96	M846-7	M846-8	M846-12	M846-18
PAB	M847-96	M847-7	M847-8	M847-12	M847-18
ORB	M849-96	M849-7	M849-8	M849-12	M849-18
OEC	M862-96	M862-7	M862-8	M862-12	M862-18
GBZ	M844-96	M844-7	M844-8	M844-12	M844-18
BSN	M841-96	M841-7	M841-8	M841-12	M841-18
AC	M843-96	M843-7	M843-8	M843-12	M843-18



WWW.TOPKNOBS.COM
 800-499-9095
 908-359-6174

Part Number is specific to shape and finish. cc = measurement center-to-center between the screw holes.

Lifetime Warranty for the original purchaser against defects in materials and craftsmanship.

Free Samples of any knob and of any pull less than 7", with a \$5 packaging and shipping charge each.

NOTE: For detailed dimensions such as overall length, height, base width, etc. see price list or visit TopKnobs.com.

NEW Normandy Twisted Appliance Pulls available in 2011



ALWAYS THE PERFECT OPENING

NEW APPLIANCE PULLS ~ 6 NEW STYLES



12" cc Edwardian Appliance Pull - matching Cabinet Pulls page 51
Tuscan Bronze TB



12" cc Griggs Appliance Pull - matching Cabinet Pulls page 61
German Bronze GBZ



12" cc Verona Appliance Pull - matching Cabinet Pulls page 61
Oil Rubbed Bronze ORB



12" cc Curved Appliance Pull - matching Cabinet Pulls page 62
Brushed Satin Nickel BSN



12" cc Rung Appliance Pull - matching Cabinet Pulls page 63
Pewter Antique PTA

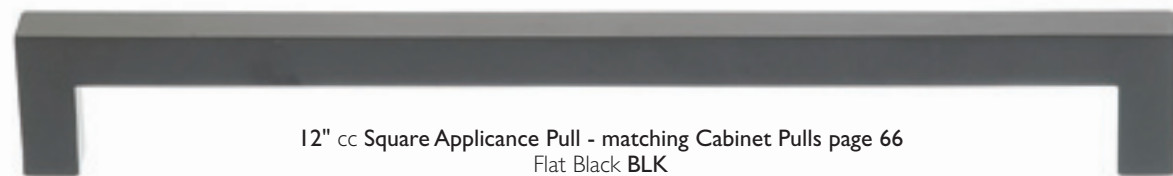

12" cc Square Appliance Pull - matching Cabinet Pulls page 66
Flat Black BLK

	TB	PTA	PN	PC	ORB	GBZ	BSN	BLK
Edwardian	TK158TB	TK158PTA	-	-	TK158ORB	TK158GBZ	-	-
Griggs	TK141TB	-	TK141PN	TK141PC	-	-	TK141BSN	TK141BLK
Verona	TK147TB	TK147PTA	TK147PN	TK147PC	TK147ORB	TK147GBZ	TK147BSN	TK147BLK
Curved Pull	-	-	TK170PN	TK170PC	-	-	TK170BSN	TK170BLK
Rung Pull	-	-	TK152PN	TK152PC	-	-	TK152BSN	TK152BLK
Square	TK164TB	-	TK164PN	TK164PC	-	-	TK164BSN	TK164BLK

Appliance Pull Collection

NEW HOPEWELL PULLS ~ 4 SIZES ~ 3/4" BAR

Matching Cabinet pulls shown on page 29



30" cc
Polished Nickel PN



24" cc
Polished Nickel PN



18" cc
Brushed Satin Nickel
BSN

Finish	30" cc	24" cc	18" cc	12" cc
PN	M1332-30	M1332-24	M1332-18	M1332-12
ORB	M1333-30	M1333-24	M1333-18	M1333-12
BSN	M1331-30	M1331-24	M1331-18	M1331-12



12" cc
Brushed Satin Nickel
BSN

NEW SANCTUARY PULLS ~ 3 STYLES

Matching Cabinet pulls shown on page 5-13



12" cc Thin Pull
Polished Chrome PC



12" cc Oval Pull
Polished Nickel PN



12" cc Arched Pull
Flat Black BLK

	TB	PTA	PN	PC	ORB	GBZ	BSN	BLK
12" cc Thin Pull	TK47TB	TK47PTA	TK47PN	TK47PC	TK47ORB	TK47GBZ	TK47BSN	TK47BLK
12" cc Oval Pull	TK67TB	TK67PTA	TK67PN	TK67PC	TK67ORB	TK67GBZ	TK67BSN	TK67BLK
12" cc Arched Pull	TK7TB	TK7PTA	TK7PN	TK7PC	TK7ORB	TK7GBZ	TK7BSN	TK7BLK

Part Number is specific to shape and finish. cc = measurement center-to-center between the screw holes.

Lifetime Warranty for the original purchaser against defects in materials and craftsmanship.

Free Samples of any knob and of any pull less than 7", with a \$5 packaging and shipping charge each.



WWW.TOPKNOBS.COM
800-499-9095
908-359-6174

NOTE: For detailed dimensions such as overall length, height, base width, etc. see price list or visit TopKnobs.com.

NOUVEAU BAMBOO PULLS ~ 5 SIZES



Finish	3 3/4" cc	7" cc	8" cc	12" cc	18" cc
RST	M724-96	M724-7	M724-8	M724-12	M724-18
PTA	M727-96	M727-7	M727-8	M727-12	M727-18
PT	M796-96	M796-7	M796-8	M796-12	M796-18
PC	M721-96	M721-7	M721-8	M721-12	M721-18
PB	M722-96	M722-7	M722-8	M722-12	M722-18
PAR	M794-96	M794-7	M794-8	M794-12	M794-18
PAB	M795-96	M795-7	M795-8	M795-12	M795-18
ORB	M797-96	M797-7	M797-8	M797-12	M797-18
OEC	M856-96	M856-7	M856-8	M856-12	M856-18
GBZ	M726-96	M726-7	M726-8	M726-12	M726-18
BSN	M723-96	M723-7	M723-8	M723-12	M723-18
AC	M725-96	M725-7	M725-8	M725-12	M725-18

NOUVEAU RING ~ 5 SIZES



Finish	3 3/4" cc	7" cc	8" cc	12" cc	18" cc
RST	M717-96	M717-7	M717-8	M717-12	M717-18
PTA	M720-96	M720-7	M720-8	M720-12	M720-18
PT	M800-96	M800-7	M800-8	M800-12	M800-18
PC	M714-96	M714-7	M714-8	M714-12	M714-18
PB	M715-96	M715-7	M715-8	M715-12	M715-18
PAR	M798-96	M798-7	M798-8	M798-12	M798-18
PAB	M799-96	M799-7	M799-8	M799-12	M799-18
ORB	M801-96	M801-7	M801-8	M801-12	M801-18
OEC	M857-96	M857-7	M857-8	M857-12	M857-18
GBZ	M719-96	M719-7	M719-8	M719-12	M719-18
BSN	M716-96	M716-7	M716-8	M716-12	M716-18
AC	M718-96	M718-7	M718-8	M718-12	M718-18

SOMERSET FINIAL ~ 5 SIZES



Finish	3 3/4" cc	7" cc	8" cc	12" cc	18" cc
RST	M820-96	M820-7	M820-8	M820-12	M820-18
PTA	M823-96	M823-7	M823-8	M823-12	M823-18
PT	M826-96	M826-7	M826-8	M826-12	M826-18
PC	M817-96	M817-7	M817-8	M817-12	M817-18
PB	M818-96	M818-7	M818-8	M818-12	M818-18
PAR	M824-96	M824-7	M824-8	M824-12	M824-18
PAB	M825-96	M825-7	M825-8	M825-12	M825-18
ORB	M827-96	M827-7	M827-8	M827-12	M827-18
OEC	M860-96	M860-7	M860-8	M860-12	M860-18
GBZ	M822-96	M822-7	M822-8	M822-12	M822-18
BSN	M819-96	M819-7	M819-8	M819-12	M819-18
AC	M821-96	M821-7	M821-8	M821-12	M821-18



SOMERSET WESTON ~ 5 SIZES



Finish	3 3/4" cc	7" cc	8" cc	12" cc	18" cc
RST	M831-96	M831-7	M831-8	M831-12	M831-18
PTA	M834-96	M834-7	M834-8	M834-12	M834-18
PT	M837-96	M837-7	M837-8	M837-12	M837-18
PC	M829-96	M829-7	M829-8	M829-12	M829-18
PB	M828-96	M828-7	M828-8	M828-12	M828-18
PAR	M835-96	M835-7	M835-8	M835-12	M835-18
PAB	M836-96	M836-7	M836-8	M836-12	M836-18
ORB	M838-96	M838-7	M838-8	M838-12	M838-18
OEC	M861-96	M861-7	M861-8	M861-12	M861-18
GBZ	M833-96	M833-7	M833-8	M833-12	M833-18
BSN	M830-96	M830-7	M830-8	M830-12	M830-18
AC	M832-96	M832-7	M832-8	M832-12	M832-18



ASBURY ~ 5 SIZES

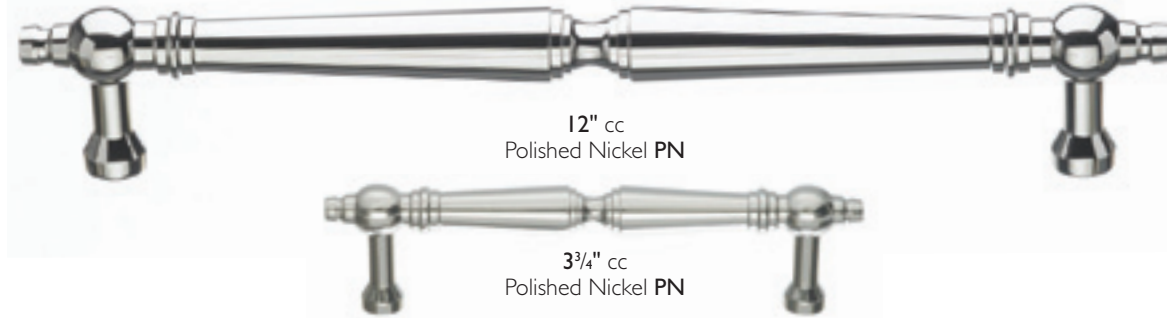

Finish	3 3/4" cc	7" cc	8" cc	12" cc	18" cc
NEW TB	M1792-96	M1792-7	M1792-8	M1792-12	M1792-18
RST	M731-96	M731-7	M731-8	M731-12	M731-18
PTA	M734-96	M734-7	M734-8	M734-12	M734-18
PT	M804-96	M804-7	M804-8	M804-12	M804-18
NEW PN	M1794-96	M1794-7	M1794-8	M1794-12	M1794-18
PC	M728-96	M728-7	M728-8	M728-12	M728-18
PB	M729-96	M729-7	M729-8	M729-12	M729-18
PAR	M802-96	M802-7	M802-8	M802-12	M802-18
PAB	M803-96	M803-7	M803-8	M803-12	M803-18
ORB	M805-96	M805-7	M805-8	M805-12	M805-18
OEC	M858-96	M858-7	M858-8	M858-12	M858-18
GBZ	M733-96	M733-7	M733-8	M733-12	M733-18
BSN	M730-96	M730-7	M730-8	M730-12	M730-18
AC	M732-96	M732-7	M732-8	M732-12	M732-18

SOMERSET MELON ~ 5 SIZES

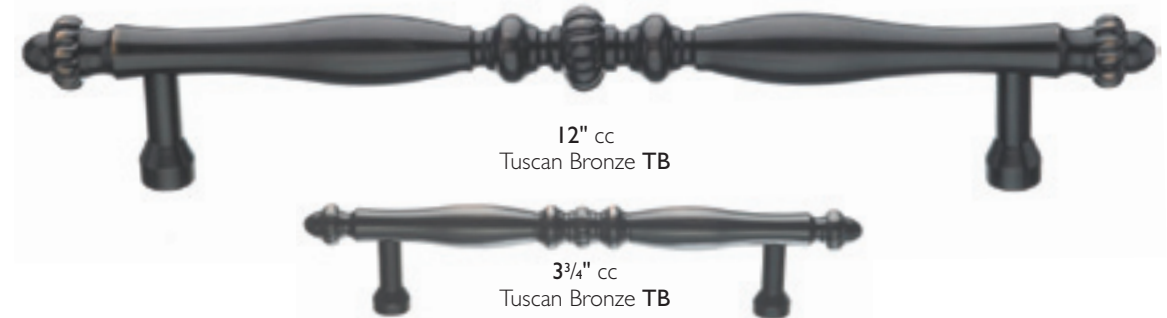

Finish	3 3/4" cc	7" cc	8" cc	12" cc	18" cc
NEW TB	M1795-96	M1795-7	M1795-8	M1795-12	M1795-18
RST	M809-96	M809-7	M809-8	M809-12	M809-18
PTA	M812-96	M812-7	M812-8	M812-12	M812-18
PT	M815-96	M815-7	M815-8	M815-12	M815-18
NEW PN	M1797-96	M1797-7	M1797-8	M1797-12	M1797-18
PC	M806-96	M806-7	M806-8	M806-12	M806-18
PB	M807-96	M807-7	M807-8	M807-12	M807-18
PAR	M813-96	M813-7	M813-8	M813-12	M813-18
PAB	M814-96	M814-7	M814-8	M814-12	M814-18
ORB	M816-96	M816-7	M816-8	M816-12	M816-18
OEC	M859-96	M859-7	M859-8	M859-12	M859-18
GBZ	M811-96	M811-7	M811-8	M811-12	M811-18
BSN	M808-96	M808-7	M808-8	M808-12	M808-18
AC	M810-96	M810-7	M810-8	M810-12	M810-18



NORMANDY BIRDCAGE PULLS ~ 6 SIZES

Matching Cabinet pulls shown on page 55

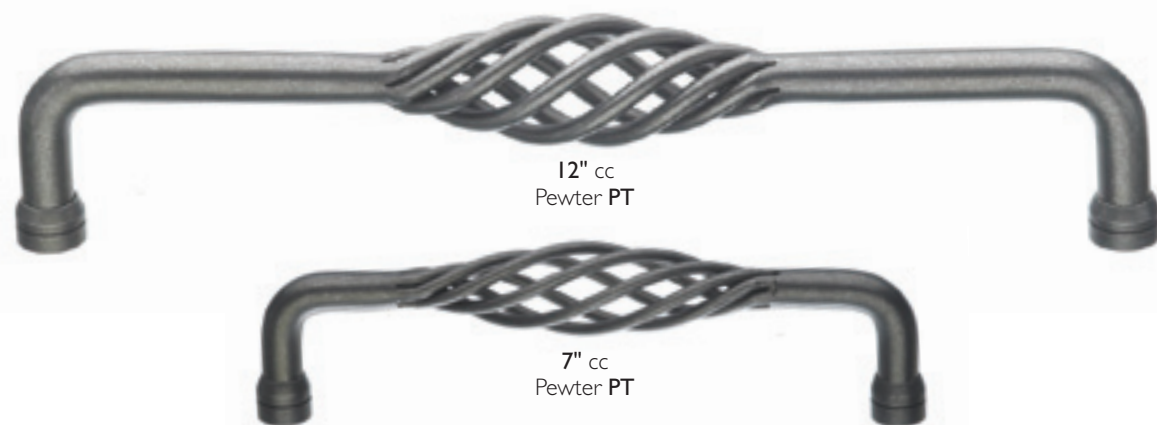

Finish	7" cc	8" cc	12" cc	18" cc	24" cc	30" cc
PT	M1242-7	M1242-8	M1242-12	M1242-18	M1242-24	M1242-30
PAR	M1244-7	M1244-8	M1244-12	M1244-18	M1244-24	M1244-30
PAB	M1243-7	M1243-8	M1243-12	M1243-18	M1243-24	M1243-30

NORMANDY TWIST APPLIANCE PULLS ~ 6 SIZES

Matching Cabinet pulls shown on page 53

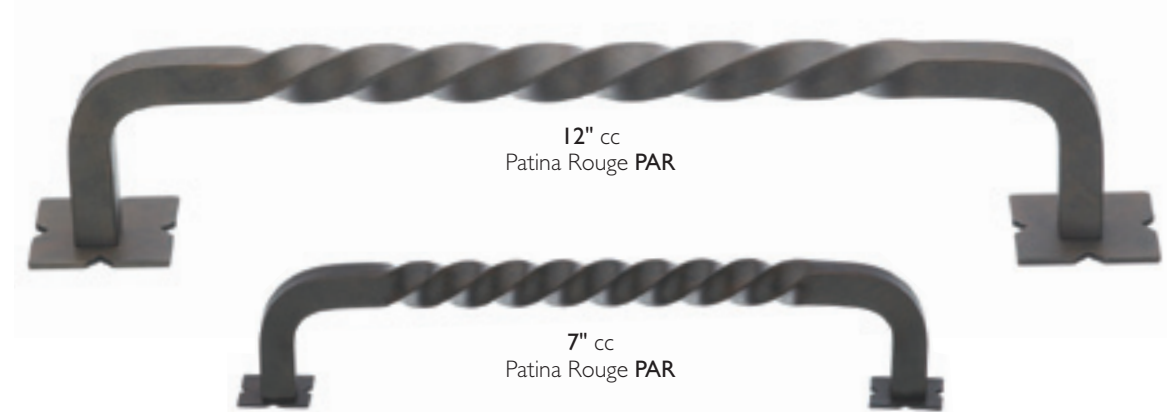

Finish	7" cc	8" cc	12" cc	18" cc	24" cc	30" cc
PT	M1247-7	M1247-8	M1247-12	M1247-18	M1247-24	M1247-30
PAR	M1245-7	M1245-8	M1245-12	M1245-18	M1245-24	M1245-30
PAB	M1246-7	M1246-8	M1246-12	M1246-18	M1246-24	M1246-30



WWW.TOPKNOBS.COM
800-499-9095
908-359-6174

NOTE: For detailed dimensions such as overall length, height, base width, etc. see price list or visit TopKnobs.com.

Part Number is specific to shape and finish. cc = measurement center-to-center between the screw holes. **Lifetime Warranty** for the original purchaser against defects in materials and craftsmanship. **Free Samples** of any knob and of any pull less than 7", with a \$5 packaging and shipping charge each.

NEW BRITANNIA THIN PULLS ~ 2 FINISHES



	TR	CI
18" cc Thin Pull	M1808	M1804

Matching Cabinet pulls shown on page 33

NEW BRITANNIA CHANNEL PULLS ~ 2 FINISHES



	TR	CI
18" cc Channel Pull	M1818	M1815
12" cc Channel Pull	M1817	M1814

Matching Cabinet pulls shown on page 33

Appliance Pull Collection

TUSCANY D-PULL APPLIANCE PULLS ~ 6 SIZES

Matching Cabinet pulls shown on page 77



Finish	7 1/2" cc	8" cc	12" cc	18" cc	24" cc	30" cc
NEW TB	M1832-7	M1832-8	M1832-12	M1832-18	M1832-24	M1832-30
RST	M1253-7	M1253-8	M1253-12	M1253-18	M1253-24	M1253-30
PTA	M1249-7	M1249-8	M1249-12	M1249-18	M1249-24	M1249-30
ORB	M1252-7	M1252-8	M1252-12	M1252-18	M1252-24	M1252-30
OEC	M1251-7	M1251-8	M1251-12	M1251-18	M1251-24	M1251-30
GBZ	M1250-7	M1250-8	M1250-12	M1250-18	M1250-24	M1250-30
DAB	M1248-7	M1248-8	M1248-12	M1248-18	M1248-24	M1248-30



NOUVEAU ~ 5 SIZES



Finish	3 3/4" cc	7" cc	8" cc	12" cc	18" cc
PC	M851-96	M851-7	M851-8	M851-12	M851-18
BSN	M850-96	M850-7	M850-8	M850-12	M850-18
BLK	M852-96	M852-7	M852-8	M852-12	M852-18

NOUVEAU BROOK ~ 5 SIZES



Finish	3 3/4" cc	7" cc	8" cc	12" cc	18" cc
PC	M854-96	M854-7	M854-8	M854-12	M854-18
BSN	M853-96	M853-7	M853-8	M853-12	M853-18
BLK	M855-96	M855-7	M855-8	M855-12	M855-18

Part Number is specific to shape and finish. cc = measurement center-to-center between the screw holes.
Lifetime Warranty for the original purchaser against defects in materials and craftsmanship.
Free Samples of any knob and of any pull less than 7", with a \$5 packaging and shipping charge each.



APPLIANCE PULL BACKPLATES & PUSH PLATES ~ 2 STYLES



M882 - Plain Appliance Backplate in Patina Rouge

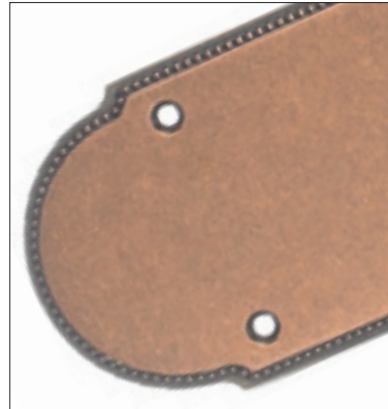

M898 - Beaded Push Plate in Old English Copper



12" cc & 15" L Beaded Appliance Backplate for 12" cc Pulls
Antique Copper AC



15" L Plain Push Plate for passage doors
Pewter PT

	RST	PTA	PT	PC	PB	PAR	PAB	ORB	OEC	GBZ	BSN	AC
12" cc Plain Backplate	M878	M881	M884	M875	M876	M882	M883	M885	M886	M880	M877	M879
12" cc Beaded Backplate	M866	M869	M872	M863	M864	M870	M871	M873	M874	M868	M865	M867
15" L Plain Push Plate	M902	M905	M908	M899	M900	M906	M907	M909	M910	M904	M901	M903
15" L Beaded Push Plate	M890	M893	M896	M887	M888	M894	M895	M897	M898	M892	M889	M891

FINISHES AVAILABLE



RST Rust PTA Pewter Antique



PT Pewter PC Polished Chrome



PB Polished Brass PAR Patina Rouge



PAB Patina Black ORB Oil Rubbed Bronze



OEC Old English Copper GBZ German Bronze



BSN Brushed Satin Nickel AC Antique Copper



WWW.TOPKNOBS.COM
800-499-9095
908-359-6174

NOTE: For detailed dimensions such as overall length, height, base width, etc. see price list or visit TopKnobs.com.

Back-to-Back Door Pull Collection

BACK-TO-BACK DOOR PULLS



M1243-18 pair
18" cc Normandy Birdcage
in Patina Black

M1246-18 pair
18" cc Normandy Twist
in Patina Black

NORMANDY



NOUVEAU BAMBOO



Finish	8" cc pair	12" cc pair	18" cc pair	8" cc pair	12" cc pair	18" cc pair
RST	M842-8 pair	M842-12 pair	M842-18 pair	M724-8 pair	M724-12 pair	M724-18 pair
PTA	M845-8 pair	M845-12 pair	M845-18 pair	M727-8 pair	M727-12 pair	M727-18 pair
PT	M848-8 pair	M848-12 pair	M848-18 pair	M796-8 pair	M796-12 pair	M796-18 pair
PC	M839-8 pair	M839-12 pair	M839-18 pair	M721-8 pair	M721-12 pair	M721-18 pair
PB	M840-8 pair	M840-12 pair	M840-18 pair	M722-8 pair	M722-12 pair	M722-18 pair
PAR	M846-8 pair	M846-12 pair	M846-18 pair	M794-8 pair	M794-12 pair	M794-18 pair
PAB	M847-8 pair	M847-12 pair	M847-18 pair	M795-8 pair	M795-12 pair	M795-18 pair
ORB	M849-8 pair	M849-12 pair	M849-18 pair	M797-8 pair	M797-12 pair	M797-18 pair
OEC	M862-8 pair	M862-12 pair	M862-18 pair	M856-8 pair	M856-12 pair	M856-18 pair
GBZ	M844-8 pair	M844-12 pair	M844-18 pair	M726-8 pair	M726-12 pair	M726-18 pair
BSN	M841-8 pair	M841-12 pair	M841-18 pair	M723-8 pair	M723-12 pair	M723-18 pair
AC	M843-8 pair	M843-12 pair	M843-18 pair	M725-8 pair	M725-12 pair	M725-18 pair

NOUVEAU RING



SOMERSET FINIAL



Finish	8" cc pair	12" cc pair	18" cc pair	8" cc pair	12" cc pair	18" cc pair
RST	M717-8 pair	M717-12 pair	M717-18 pair	M820-8 pair	M820-12 pair	M820-18 pair
PTA	M720-8 pair	M720-12 pair	M720-18 pair	M823-8 pair	M823-12 pair	M823-18 pair
PT	M800-8 pair	M800-12 pair	M800-18 pair	M826-8 pair	M826-12 pair	M826-18 pair
PC	M714-8 pair	M714-12 pair	M714-18 pair	M817-8 pair	M817-12 pair	M817-18 pair
PB	M715-8 pair	M715-12 pair	M715-18 pair	M818-8 pair	M818-12 pair	M818-18 pair
PAR	M798-8 pair	M798-12 pair	M798-18 pair	M824-8 pair	M824-12 pair	M824-18 pair
PAB	M799-8 pair	M799-12 pair	M799-18 pair	M825-8 pair	M825-12 pair	M825-18 pair
ORB	M801-8 pair	M801-12 pair	M801-18 pair	M827-8 pair	M827-12 pair	M827-18 pair
OEC	M857-8 pair	M857-12 pair	M857-18 pair	M860-8 pair	M860-12 pair	M860-18 pair
GBZ	M719-8 pair	M719-12 pair	M719-18 pair	M822-8 pair	M822-12 pair	M822-18 pair
BSN	M716-8 pair	M716-12 pair	M716-18 pair	M819-8 pair	M819-12 pair	M819-18 pair
AC	M718-8 pair	M718-12 pair	M718-18 pair	M821-8 pair	M821-12 pair	M821-18 pair

Part Number is specific to shape and finish. cc = measurement center-to-center between the screw holes.

Lifetime Warranty for the original purchaser against defects in materials and craftsmanship.

BACK-TO-BACK DOOR PULLS

SOMERSET MELON



TUSCANY



DAB
Dark Antique Brass

Finish	8" cc pair	12" cc pair	18" cc pair	12" cc pair	18" cc pair
RST	M809-8 pair	M809-12 pair	M809-18 pair	M1253-12 pair	M1253-18 pair
PTA	M812-8 pair	M812-12 pair	M812-18 pair	M1249-12 pair	M1249-18 pair
PT	M815-8 pair	M815-12 pair	M815-18 pair	-	-
PC	M806-8 pair	M806-12 pair	M806-18 pair	-	-
PB	M807-8 pair	M807-12 pair	M807-18 pair	-	-
PAR	M813-8 pair	M813-12 pair	M813-18 pair	-	-
PAB	M814-8 pair	M814-12 pair	M814-18 pair	-	-
ORB	M816-8 pair	M816-12 pair	M816-18 pair	M1252-12 pair	M1252-18 pair
OEC	M859-8 pair	M859-12 pair	M859-18 pair	M1251-12 pair	M1251-18 pair
GBZ	M811-8 pair	M811-12 pair	M811-18 pair	M1250-12 pair	M1250-18 pair
DAB	-	-	-	M1248-12 pair	M1248-18 pair
BSN	M808-8 pair	M808-12 pair	M808-18 pair	-	-
AC	M810-8 pair	M810-12 pair	M810-18 pair	-	-

NORMANDY BIRDCAGE



NORMANDY TWIST



Finish	8" cc pair	12" cc pair	18" cc pair	8" cc pair	12" cc pair	18" cc pair
PT	M1242-8 pair	M1242-12 pair	M1242-18 pair	M1247-8 pair	M1247-12 pair	M1247-18 pair
PAR	M1244-8 pair	M1244-12 pair	M1244-18 pair	M1245-8 pair	M1245-12 pair	M1245-18 pair
PAB	M1243-8 pair	M1243-12 pair	M1243-18 pair	M1246-8 pair	M1246-12 pair	M1246-18 pair

SOMERSET WESTON



ASBURY



Finish	8" cc pair	12" cc pair	18" cc pair	8" cc pair	12" cc pair	18" cc pair
RST	M831-8 pair	M831-12 pair	M831-18 pair	M731-8 pair	M731-12 pair	M731-18 pair
PTA	M834-8 pair	M834-12 pair	M834-18 pair	M734-8 pair	M734-12 pair	M734-18 pair
PT	M837-8 pair	M837-12 pair	M837-18 pair	M804-8 pair	M804-12 pair	M804-18 pair
PC	M829-8 pair	M829-12 pair	M829-18 pair	M728-8 pair	M728-12 pair	M728-18 pair
PB	M828-8 pair	M828-12 pair	M828-18 pair	M729-8 pair	M729-12 pair	M729-18 pair
PAR	M835-8 pair	M835-12 pair	M835-18 pair	M802-8 pair	M802-12 pair	M802-18 pair
PAB	M836-8 pair	M836-12 pair	M836-18 pair	M803-8 pair	M803-12 pair	M803-18 pair
ORB	M838-8 pair	M838-12 pair	M838-18 pair	M805-8 pair	M805-12 pair	M805-18 pair
OEC	M861-8 pair	M861-12 pair	M861-18 pair	M858-8 pair	M858-12 pair	M858-18 pair
GBZ	M833-8 pair	M833-12 pair	M833-18 pair	M733-8 pair	M733-12 pair	M733-18 pair
BSN	M830-8 pair	M830-12 pair	M830-18 pair	M730-8 pair	M730-12 pair	M730-18 pair
AC	M832-8 pair	M832-12 pair	M832-18 pair	M732-8 pair	M732-12 pair	M732-18 pair

NOUVEAU



NOUVEAU BROOK



Finish	8" cc pair	12" cc pair	18" cc pair	8" cc pair	12" cc pair	18" cc pair
PC	M851-8 pair	M851-12 pair	M851-18 pair	M854-8 pair	M854-12 pair	M854-18 pair
BSN	M850-8 pair	M850-12 pair	M850-18 pair	M853-8 pair	M853-12 pair	M853-18 pair
BLK	M852-8 pair	M852-12 pair	M852-18 pair	M855-8 pair	M855-12 pair	M855-18 pair

PULL END CAPS ~ 1 STYLE

End caps are sold in pairs as shown – sets are used to mount 8", 12" and 18" handles for one-sided applications. Please visit our website for ordering details.

RST	PTA	PT	PC				
M977-pair	M980-pair	M983-pair	M974-pair				
PB	PAR	PAB	ORB	OEC	GBZ	BSN	AC
M975-pair	M981-pair	M982-pair	M984-pair	M985-pair	M979-pair	M976-pair	M978-pair



Appliance Pull End Caps
Old English Copper OEC



RST
Rust



PTA
Pewter Antique



PT
Pewter



PC
Polished Chrome



PB
Polished Brass



PAR
Patina Rouge



PAB
Patina Black

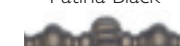

ORB
Oil Rubbed Bronze

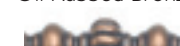

OEC
Old English Copper

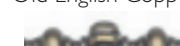

GBZ
German Bronze



DAB
Dark Antique Brass



BSN
Brushed Satin Nickel

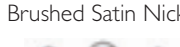

AC
Antique Copper





ACCENTS FOR EXCEPTIONAL SPACES

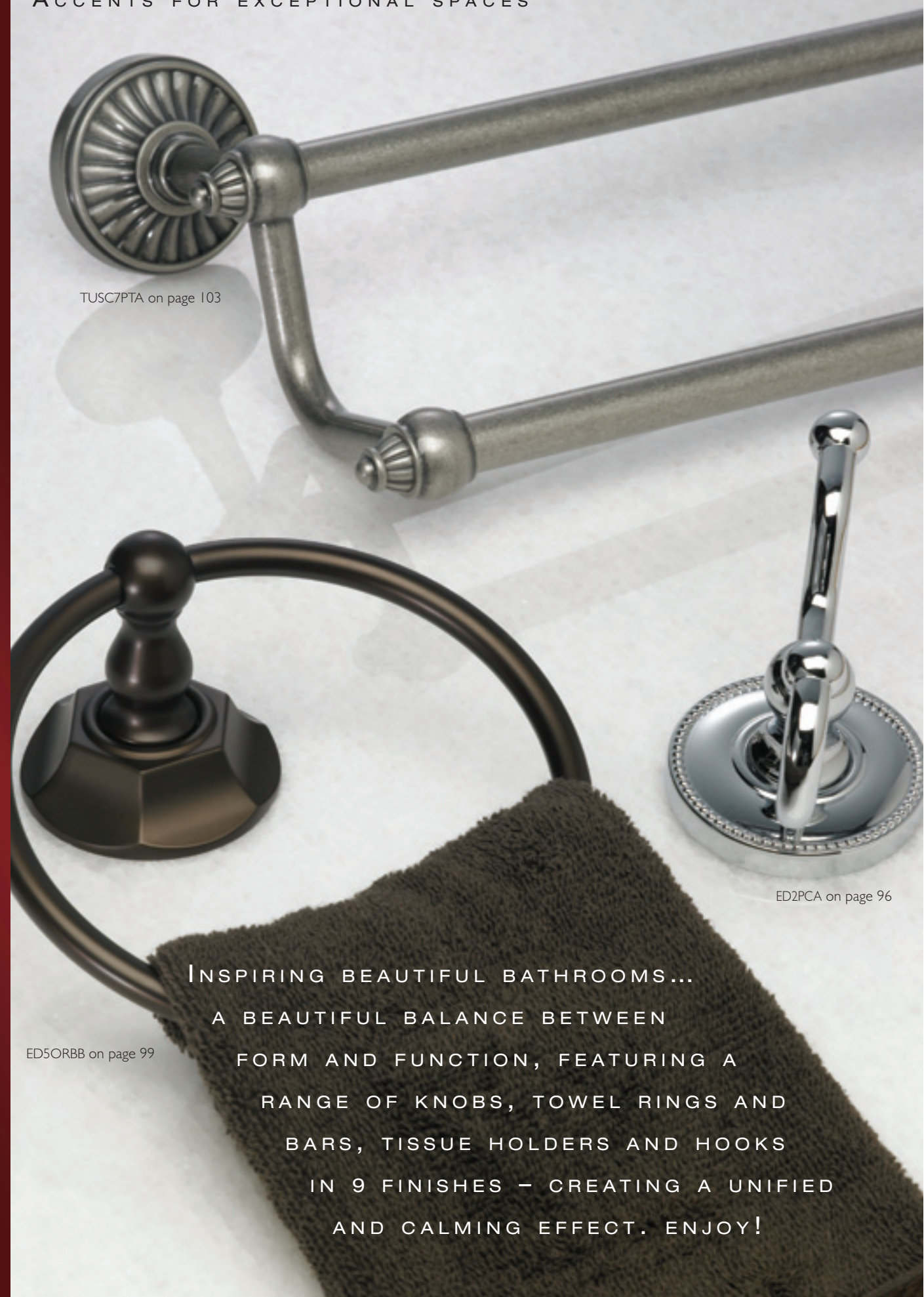

TUSC7PTA on page 103

ED2PCA on page 96

ED5ORBB on page 99

INSPIRING BEAUTIFUL BATHROOMS...
 A BEAUTIFUL BALANCE BETWEEN
 FORM AND FUNCTION, FEATURING A
 RANGE OF KNOBS, TOWEL RINGS AND
 BARS, TISSUE HOLDERS AND HOOKS
 IN 9 FINISHES – CREATING A UNIFIED
 AND CALMING EFFECT. ENJOY!

Aqua Bath Collection

TOWEL BARS ~ 3 SIZES: 18", 24" & 30"



24" Double Towel Bar
Brushed Bronze

24" Single Towel Bar
Polished Nickel

ACCESSORIES ~ 4 ITEMS



Single Hook
Polished Chrome

Tissue Holder
Polished Chrome

Tissue Hook
Brushed Satin Nickel

Towel Ring
Brushed Satin Nickel

FINISHES AVAILABLE

PN
Polished
Nickel

PC
Polished
Chrome

BSN
Brushed
Satin Nickel

BB
Brushed
Bronze

Finish	18" Double Bar	18" Single Bar	24" Double Bar	24" Single Bar	30" Double Bar	30" Single Bar	Single Hook	Tissue Holder	Tissue Hook	Towel Ring
PN	AQ7PN	AQ6PN	AQ9PN	AQ8PN	AQ11PN	AQ10PN	AQ1PN	AQ3PN	AQ4PN	AQ5PN
PC	AQ7PC	AQ6PC	AQ9PC	AQ8PC	AQ11PC	AQ10PC	AQ1PC	AQ3PC	AQ4PC	AQ5PC
BSN	AQ7BSN	AQ6BSN	AQ9BSN	AQ8BSN	AQ11BSN	AQ10BSN	AQ1BSN	AQ3BSN	AQ4BSN	AQ5BSN
BB	AQ7BB	AQ6BB	AQ9BB	AQ8BB	AQ11BB	AQ10BB	AQ1BB	AQ3BB	AQ4BB	AQ5BB

www.TopKnobs.com
 800-499-9095
 908-359-6174

Part Number is specific to shape and finish. cc = measurement center-to-center between the screw holes.
Lifetime Warranty for the original purchaser against defects in materials and craftsmanship.

BEADED ACCESSORIES & TOWEL BARS: 18", 24" & 30"

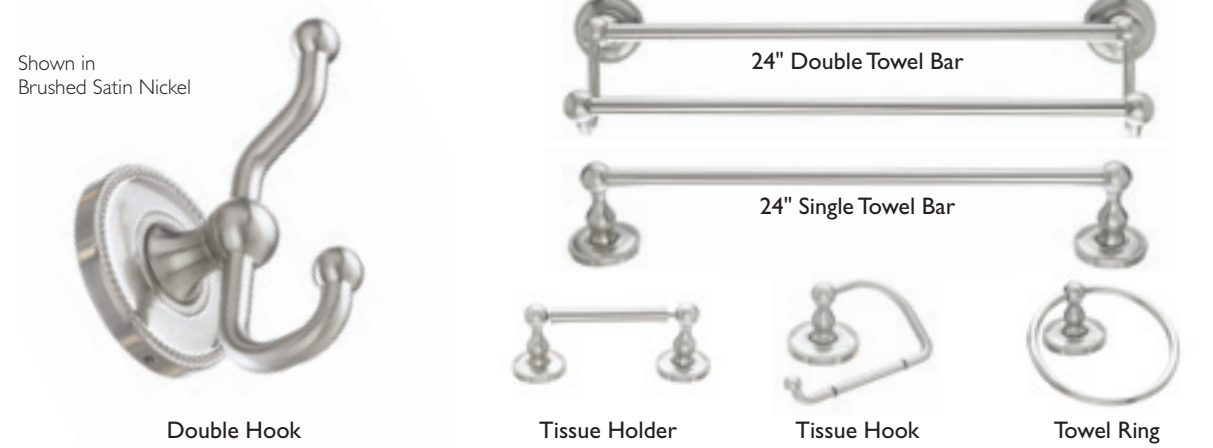

Finish	18" Double Bar	18" Single Bar	24" Double Bar	24" Single Bar	30" Double Bar	30" Single Bar	Double Hook	Tissue Holder	Tissue Hook	Towel Ring
PC	ED7PCA	ED6PCA	ED9PCA	ED8PCA	ED11PCA	ED10PCA	ED2PCA	ED3PCA	ED4PCA	ED5PCA
ORB	ED7ORBA	ED6ORBA	ED9ORBA	ED8ORBA	ED11ORBA	ED10ORBA	ED2ORBA	ED3ORBA	ED4ORBA	ED5ORBA
GBZ	ED7GBZA	ED6GBZA	ED9GBZA	ED8GBZA	ED11GBZA	ED10GBZA	ED2GBZA	ED3GBZA	ED4GBZA	ED5GBZA
BSN	ED7BSNA	ED6BSNA	ED9BSNA	ED8BSNA	ED11BSNA	ED10BSNA	ED2BSNA	ED3BSNA	ED4BSNA	ED5BSNA
AP	ED7APA	ED6APA	ED9APA	ED8APA	ED11APA	ED10APA	ED2APA	ED3APA	ED4APA	ED5APA

ROPE ACCESSORIES & TOWEL BARS: 18", 24" & 30"

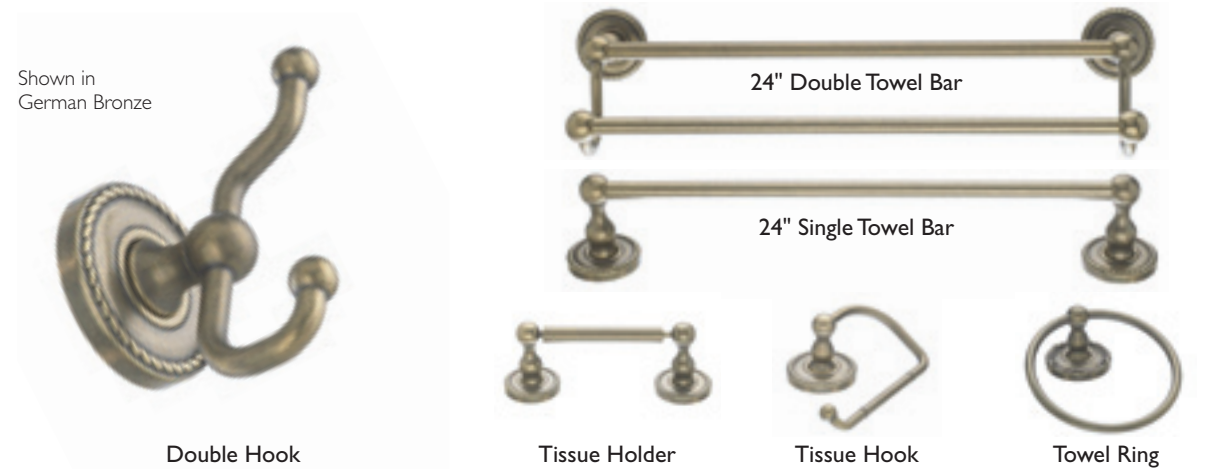

Finish	18" Double Bar	18" Single Bar	24" Double Bar	24" Single Bar	30" Double Bar	30" Single Bar	Double Hook	Tissue Holder	Tissue Hook	Towel Ring
PC	ED7PCF	ED6PCF	ED9PCF	ED8PCF	ED11PCF	ED10PCF	ED2PCF	ED3PCF	ED4PCF	ED5PCF
ORB	ED7ORBF	ED6ORBF	ED9ORBF	ED8ORBF	ED11ORBF	ED10ORBF	ED2ORBF	ED3ORBF	ED4ORBF	ED5ORBF
GBZ	ED7GBZF	ED6GBZF	ED9GBZF	ED8GBZF	ED11GBZF	ED10GBZF	ED2GBZF	ED3GBZF	ED4GBZF	ED5GBZF
BSN	ED7BSNF	ED6BSNF	ED9BSNF	ED8BSNF	ED11BSNF	ED10BSNF	ED2BSNF	ED3BSNF	ED4BSNF	ED5BSNF
AP	ED7APF	ED6APF	ED9APF	ED8APF	ED11APF	ED10APF	ED2APF	ED3APF	ED4APF	ED5APF

RIBBON & REED TOWEL BARS ~ 3 SIZES: 18", 24" & 30"

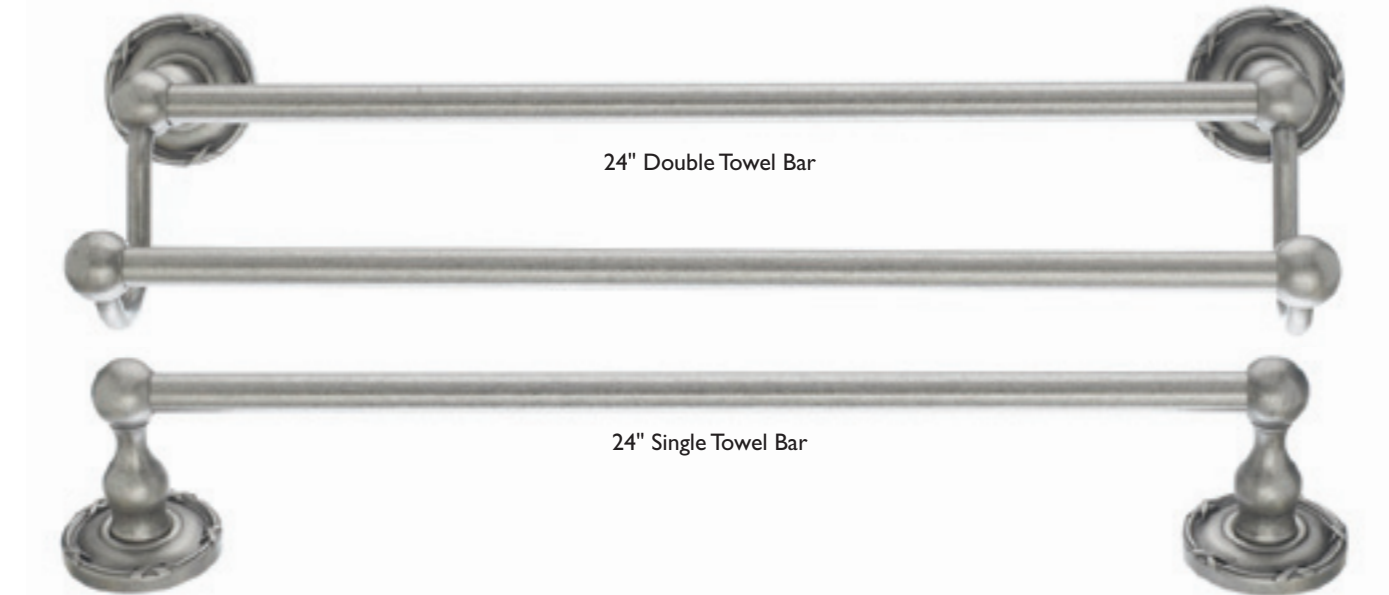

Shown in Antique Pewter

RIBBON & REED ACCESSORIES ~ 4 ITEMS

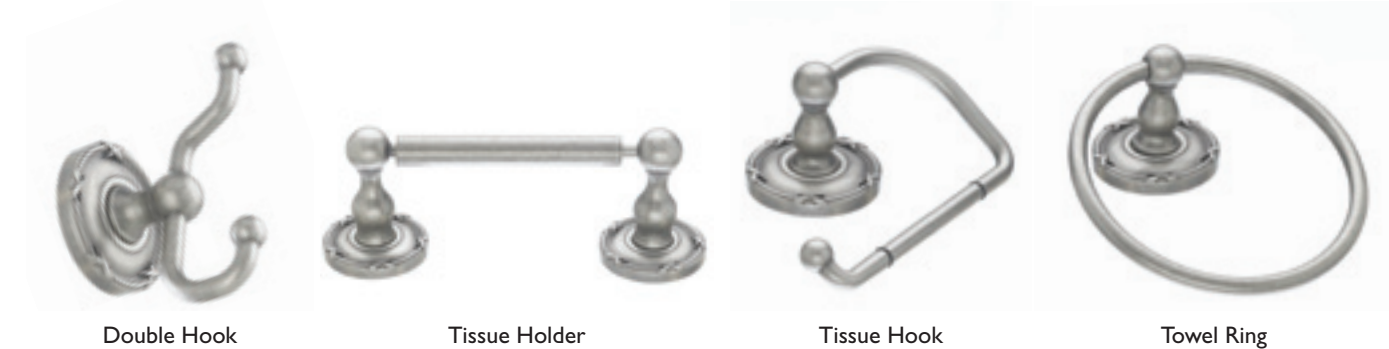

FINISHES AVAILABLE



Finish	18" Double Bar	18" Single Bar	24" Double Bar	24" Single Bar	30" Double Bar	30" Single Bar	Double Hook	Tissue Holder	Tissue Hook	Towel Ring
PC	ED7PCE	ED6PCE	ED9PCE	ED8PCE	ED11PCE	ED10PCE	ED2PCE	ED3PCE	ED4PCE	ED5PCE
ORB	ED7ORBE	ED6ORBE	ED9ORBE	ED8ORBE	ED11ORBE	ED10ORBE	ED2ORBE	ED3ORBE	ED4ORBE	ED5ORBE
GBZ	ED7GBZE	ED6GBZE	ED9GBZE	ED8GBZE	ED11GBZE	ED10GBZE	ED2GBZE	ED3GBZE	ED4GBZE	ED5GBZE
BSN	ED7BSNE	ED6BSNE	ED9BSNE	ED8BSNE	ED11BSNE	ED10BSNE	ED2BSNE	ED3BSNE	ED4BSNE	ED5BSNE
AP	ED7APE	ED6APE	ED9APE	ED8APE	ED11APE	ED10APE	ED2APE	ED3APE	ED4APE	ED5APE



NOTE: For detailed dimensions such as overall length, height, base width, etc. see price list or visit TopKnobs.com.

Part Number is specific to shape and finish. cc = measurement center-to-center between the screw holes. Lifetime Warranty for the original purchaser against defects in materials and craftsmanship.

SMOOTH ACCESSORIES & TOWEL BARS: 18", 24" & 30"



Finish	18" Double Bar	18" Single Bar	24" Double Bar	24" Single Bar	30" Double Bar	30" Single Bar	Double Hook	Tissue Holder	Tissue Hook	Towel Ring
PC	ED7PCD	ED6PCD	ED9PCD	ED8PCD	ED11PCD	ED10PCD	ED2PCD	ED3PCD	ED4PCD	ED5PCD
ORB	ED7ORBD	ED6ORBD	ED9ORBD	ED8ORBD	ED11ORBD	ED10ORBD	ED2ORBD	ED3ORBD	ED4ORBD	ED5ORBD
GBZ	ED7GBZD	ED6GBZD	ED9GBZD	ED8GBZD	ED11GBZD	ED10GBZD	ED2GBZD	ED3GBZD	ED4GBZD	ED5GBZD
BSN	ED7BSND	ED6BSND	ED9BSND	ED8BSND	ED11BSND	ED10BSND	ED2BSND	ED3BSND	ED4BSND	ED5BSND
AP	ED7APD	ED6APD	ED9APD	ED8APD	ED11APD	ED10APD	ED2APD	ED3APD	ED4APD	ED5APD

OVAL ACCESSORIES & TOWEL BARS: 18", 24" & 30"

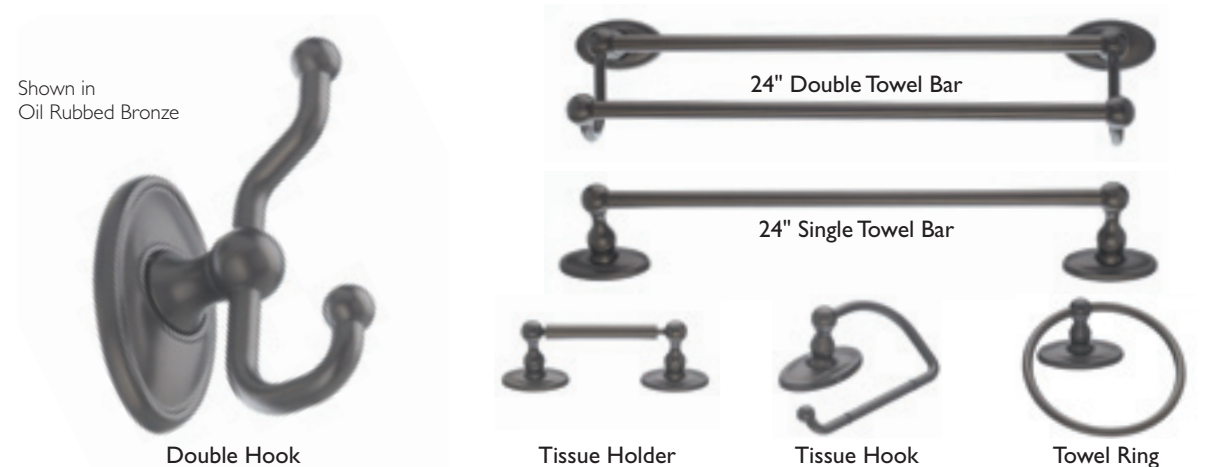

Finish	18" Double Bar	18" Single Bar	24" Double Bar	24" Single Bar	30" Double Bar	30" Single Bar	Double Hook	Tissue Holder	Tissue Hook	Towel Ring
PC	ED7PCC	ED6PCC	ED9PCC	ED8PCC	ED11PCC	ED10PCC	ED2PCC	ED3PCC	ED4PCC	ED5PCC
ORB	ED7ORBC	ED6ORBC	ED9ORBC	ED8ORBC	ED11ORBC	ED10ORBC	ED2ORBC	ED3ORBC	ED4ORBC	ED5ORBC
GBZ	ED7GBZC	ED6GBZC	ED9GBZC	ED8GBZC	ED11GBZC	ED10GBZC	ED2GBZC	ED3GBZC	ED4GBZC	ED5GBZC
BSN	ED7BSNC	ED6BSNC	ED9BSNC	ED8BSNC	ED11BSNC	ED10BSNC	ED2BSNC	ED3BSNC	ED4BSNC	ED5BSNC
AP	ED7APC	ED6APC	ED9APC	ED8APC	ED11APC	ED10APC	ED2APC	ED3APC	ED4APC	ED5APC

HEX TOWEL BARS ~ 3 SIZES: 18", 24" & 30"



HEX ACCESSORIES ~ 4 ITEMS



FINISHES AVAILABLE



Finish	18" Double Bar	18" Single Bar	24" Double Bar	24" Single Bar	30" Double Bar	30" Single Bar	Double Hook	Tissue Holder	Tissue Hook	Towel Ring
PC	ED7PCB	ED6PCB	ED9PCB	ED8PCB	ED11PCB	ED10PCB	ED2PCB	ED3PCB	ED4PCB	ED5PCB
ORB	ED7ORBB	ED6ORBB	ED9ORBB	ED8ORBB	ED11ORBB	ED10ORBB	ED2ORBB	ED3ORBB	ED4ORBB	ED5ORBB
GBZ	ED7GBZB	ED6GBZB	ED9GBZB	ED8GBZB	ED11GBZB	ED10GBZB	ED2GBZB	ED3GBZB	ED4GBZB	ED5GBZB
BSN	ED7BSNB	ED6BSNB	ED9BSNB	ED8BSNB	ED11BSNB	ED10BSNB	ED2BSNB	ED3BSNB	ED4BSNB	ED5BSNB
AP	ED7APB	ED6APB	ED9APB	ED8APB	ED11APB	ED10APB	ED2APB	ED3APB	ED4APB	ED5APB



NOTE: For detailed dimensions such as overall length, height, base width, etc. see price list or visit TopKnobs.com.

Part Number is specific to shape and finish. cc = measurement center-to-center between the screw holes. Lifetime Warranty for the original purchaser against defects in materials and craftsmanship.



ACCENTS FOR EXCEPTIONAL SPACES

HOPEWELL TOWEL BARS ~ 3 SIZES: 18", 24" & 30"



24" Double Towel Bar
Polished Nickel

24" Single Towel Bar
Brushed Satin Nickel

HOPEWELL ACCESSORIES ~ 4 ITEMS

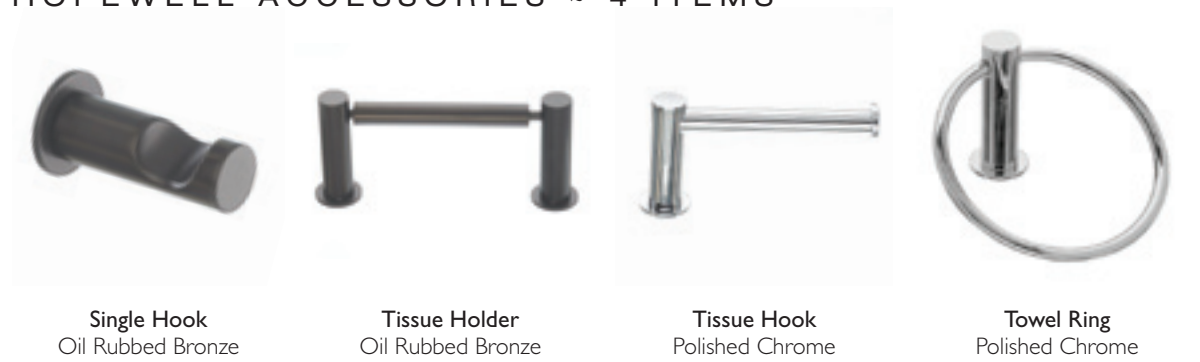

Single Hook
Oil Rubbed Bronze

Tissue Holder
Oil Rubbed Bronze

Tissue Hook
Polished Chrome

Towel Ring
Polished Chrome

FINISHES AVAILABLE

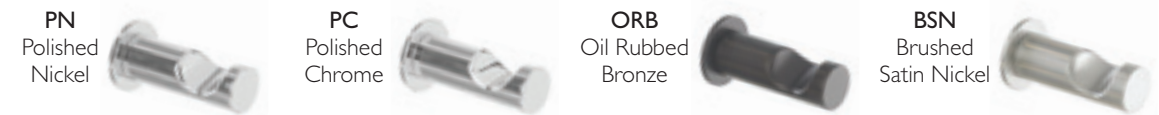

Finish	18" Double Bar	18" Single Bar	24" Double Bar	24" Single Bar	30" Double Bar	30" Single Bar	Single Hook	Tissue Holder	Tissue Hook	Towel Ring
PN	HOP7PN	HOP6PN	HOP9PN	HOP8PN	HOP11PN	HOP10PN	HOP1PN	HOP3PN	HOP4PN	HOP5PN
PC	HOP7PC	HOP6PC	HOP9PC	HOP8PC	HOP11PC	HOP10PC	HOP1PC	HOP3PC	HOP4PC	HOP5PC
ORB	HOP7ORB	HOP6ORB	HOP9ORB	HOP8ORB	HOP11ORB	HOP10ORB	HOP1ORB	HOP3ORB	HOP4ORB	HOP5ORB
BSN	HOP7BSN	HOP6BSN	HOP9BSN	HOP8BSN	HOP11BSN	HOP10BSN	HOP1BSN	HOP3BSN	HOP4BSN	HOP5BSN

Hopewell & Hudson Bath Collection

HUDSON TOWEL BARS ~ 3 SIZES: 18", 24" & 30"



24" Double Towel Bar
Tuscan Bronze

24" Single Towel Bar
Polished Nickel

HUDSON ACCESSORIES ~ 4 ITEMS

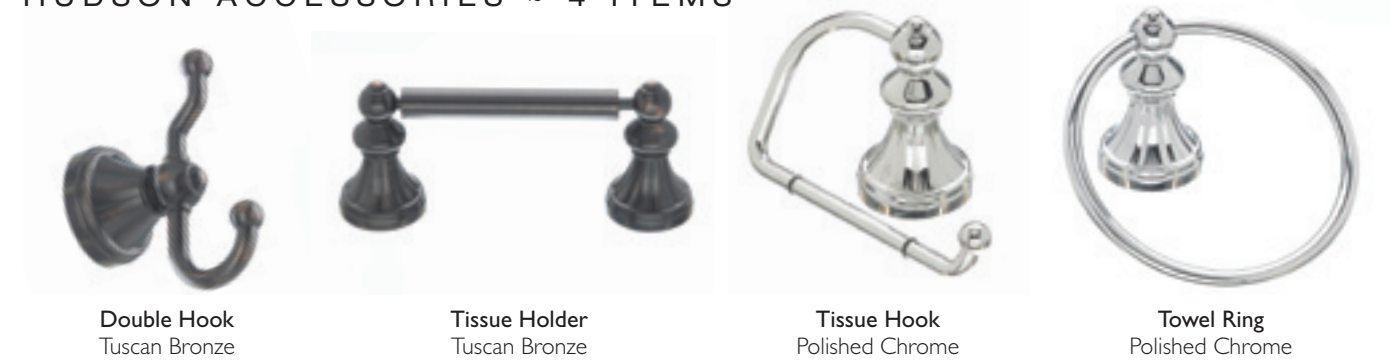

Double Hook
Tuscan Bronze

Tissue Holder
Tuscan Bronze

Tissue Hook
Polished Chrome

Towel Ring
Polished Chrome

FINISHES AVAILABLE



Finish	18" Double Bar	18" Single Bar	24" Double Bar	24" Single Bar	30" Double Bar	30" Single Bar	Double Hook	Tissue Holder	Tissue Hook	Towel Ring
TB	HUD7TB	HUD6TB	HUD9TB	HUD8TB	HUD11TB	HUD10TB	HUD2TB	HUD3TB	HUD4TB	HUD5TB
PN	HUD7PN	HUD6PN	HUD9PN	HUD8PN	HUD11PN	HUD10PN	HUD2PN	HUD3PN	HUD4PN	HUD5PN
PC	HUD7PC	HUD6PC	HUD9PC	HUD8PC	HUD11PC	HUD10PC	HUD2PC	HUD3PC	HUD4PC	HUD5PC
BSN	HUD7BSN	HUD6BSN	HUD9BSN	HUD8BSN	HUD11BSN	HUD10BSN	HUD2BSN	HUD3BSN	HUD4BSN	HUD5BSN

NOTE: For detailed dimensions such as overall length, height, base width, etc. see price list or visit TopKnobs.com.

www.TopKnobs.com
800-499-9095
908-359-6174

Part Number is specific to shape and finish. cc = measurement center-to-center between the screw holes.
Lifetime Warranty for the original purchaser against defects in materials and craftsmanship.



ACCENTS FOR EXCEPTIONAL SPACES

STRATTON TOWEL BARS ~ 3 SIZES: 18", 24" & 30"



24" Double Towel Bar
Brushed Satin Nickel

24" Single Towel Bar
Brushed Bronze

STRATTON ACCESSORIES ~ 4 ITEMS



Double Hook
Antique Pewter

Tissue Holder
Polished Nickel

Tissue Hook
Tuscan Bronze

Towel Ring
Brushed Satin Nickel

FINISHES AVAILABLE



Finish	18" Double Bar	18" Single Bar	24" Double Bar	24" Single Bar	30" Double Bar	30" Single Bar	Double Hook	Tissue Holder	Tissue Hook	Towel Ring
TB	STK7TB	STK6TB	STK9TB	STK8TB	STK11TB	STK10TB	STK2TB	STK3TB	STK4TB	STK5TB
PN	STK7PN	STK6PN	STK9PN	STK8PN	STK11PN	STK10PN	STK2PN	STK3PN	STK4PN	STK5PN
BSN	STK7BSN	STK6BSN	STK9BSN	STK8BSN	STK11BSN	STK10BSN	STK2BSN	STK3BSN	STK4BSN	STK5BSN
BB	STK7BB	STK6BB	STK9BB	STK8BB	STK11BB	STK10BB	STK2BB	STK3BB	STK4BB	STK5BB
AP	STK7AP	STK6AP	STK9AP	STK8AP	STK11AP	STK10AP	STK2AP	STK3AP	STK4AP	STK5AP

Stratton & Tuscany Bath Collection

TUSCANY TOWEL BARS ~ 3 SIZES: 18", 24" & 30"



24" Double Towel Bar
German Bronze

24" Single Towel Bar
Pewter Antique

TUSCANY ACCESSORIES ~ 4 ITEMS



Double Hook
Oil Rubbed Bronze

Tissue Holder
Oil Rubbed Bronze

Tissue Hook
Pewter Antique

Towel Ring
Pewter Antique

FINISHES AVAILABLE



Finish	18" Double Bar	18" Single Bar	24" Double Bar	24" Single Bar	30" Double Bar	30" Single Bar	Double Hook	Tissue Holder	Tissue Hook	Towel Ring
PTA	TUSC7PTA	TUSC6PTA	TUSC9PTA	TUSC8PTA	TUSC11PTA	TUSC10PTA	TUSC2PTA	TUSC3PTA	TUSC4PTA	TUSC5PTA
ORB	TUSC7ORB	TUSC6ORB	TUSC9ORB	TUSC8ORB	TUSC11ORB	TUSC10ORB	TUSC2ORB	TUSC3ORB	TUSC4ORB	TUSC5ORB
GBZ	TUSC7GBZ	TUSC6GBZ	TUSC9GBZ	TUSC8GBZ	TUSC11GBZ	TUSC10GBZ	TUSC2GB	TUSC3GB	TUSC4GB	TUSC5GB
BSN	TUSC7BSN	TUSC6BSN	TUSC9BSN	TUSC8BSN	TUSC11BSN	TUSC10BSN	TUSC2BSN	TUSC3BSN	TUSC4BSN	TUSC5BSN



WWW.TOPKNOBS.COM
800-499-9095
908-359-6174

NOTE: For detailed dimensions such as overall length, height, base width, etc. see price list or visit TopKnobs.com.

Part Number is specific to shape and finish. cc = measurement center-to-center between the screw holes. Lifetime Warranty for the original purchaser against defects in materials and craftsmanship.

A DISPLAY OF FINE CRAFTSMANSHIP.

Quality you've got to see and feel to believe.

While the beauty of our collections is apparent in our catalog, it's important for customers to experience our knobs and pulls first-hand in the showroom. Our display boards encourage customers to see, touch and examine the fine craftsmanship and sturdy design for themselves – feeling the solid weight in their hands.

To complement the form and finish of our collections, display boards are available in white or maple finish and come in a unified size – 22.5" x 22.5". In addition, you may select from our three display towers, which feature a 6 or 8-board wire, a 12-board premium wood version or a merchandiser, which comes in a maple finish.

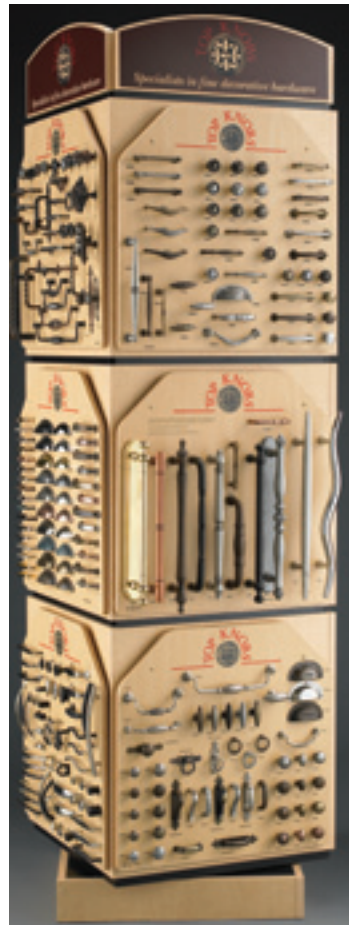

Maple finish
84" x 26" x 26"



White finish
84" x 26" x 26"



APPLIANCE



ASBURY

DISPLAY BOARD COLLECTIONS



ASPEN



BAR PULLS

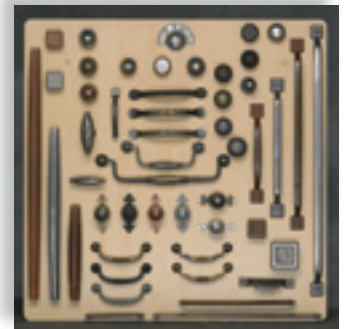

BRITANNIA



CHATEAU



CHATEAU II



DAKOTA



EDWARDIAN



NEW ADDITIONS



NORMANDY



NOUVEAU

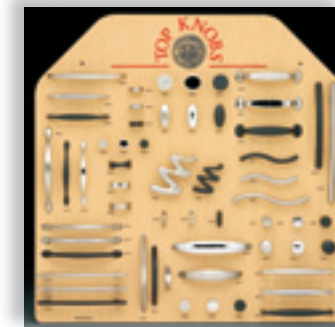

NOUVEAU II



NOUVEAU III



DISPLAY BOARD COLLECTIONS

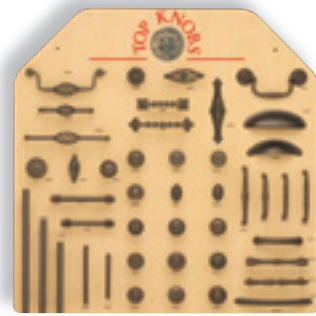

OIL RUBBED BRONZE

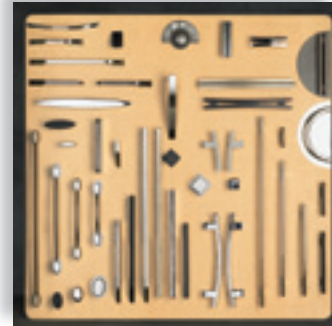

SANCTUARY



SOMERSET



SOMERSET II

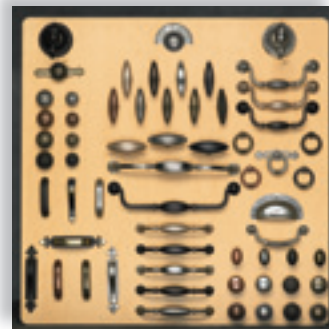

TUSCANY



BATH - AQUA



BATH - EDWARDIAN



BATH - HOPEWELL



BATH - HUDSON



BATH - STRATTON



BATH - TUSCANY



BEAUTIFUL, FROM START TO FINISH.

30 sealed finishes, each with a personality all its own.

From the color of the walls to the surface of the countertops, your kitchen and bath are a reflection of your style. And when it comes to knobs, pulls, and accessories we believe you should have the same opportunity to express yourself. That's why each of our collections are available in multiple finishes.

Maybe you want to match the finish of your cabinet. Or choose one that is complementary to your appliances or your walls. Regardless of your design preferences, we offer 30 colorful finishes to suit your personal tastes. Plus, our finishes are sealed, allowing them to stand up to the toughest conditions and maintain their good looks over time. Finishes are hand-applied, creating the slight variations product to product that add character and elegance.

FINISHES KEY ~ 30 FINISHES



cc = center-to-center

W = Width

L = Length