

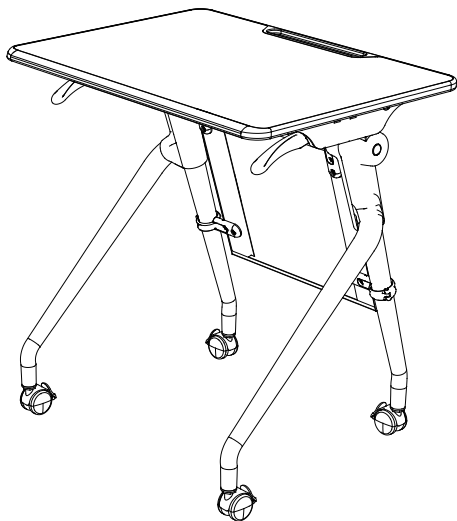

San Diego, CA 92110  
www.ecr4kids.com

# Rolling Desk







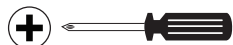

## ELR-24106

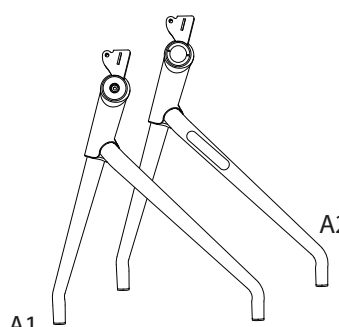

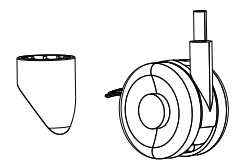
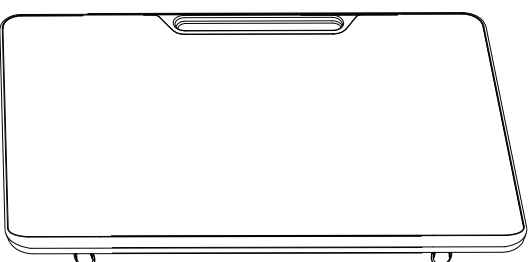
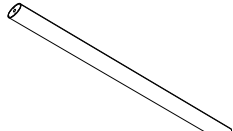
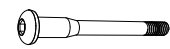
EASY  
FÁCIL  
FACILE

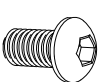
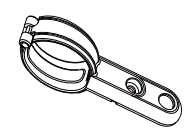
HARD  
DIFÍCIL  
DIFFICILE

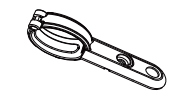
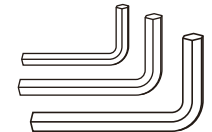

<b>A</b>  A1 A2 1x/1x	<b>H</b>  2x
<b>B</b>  B1 B2 4x/4x	<b>I</b>  1x
<b>C</b>  1x	<b>J</b>  2x
<b>D</b>  1x	<b>K</b>  8x
<b>E</b>  2x	<b>L</b>  2x
<b>F</b>  2x	<b>M</b>  3x
<b>G</b>  2x	<b>N</b>  1x

**1**

BEFORE ASSEMBLING, MAKE SURE YOU HAVE ALL THE PARTS  
 ANTES DE ENSAMBLAR, ASEGÚRESE DE QUE TIENE TODAS LAS PARTES  
 ASSUREZ-VOUS QUE VOUS AVEZ TOUTES LES PIÈCES AVANT  
 L'ASSEMBLAGE

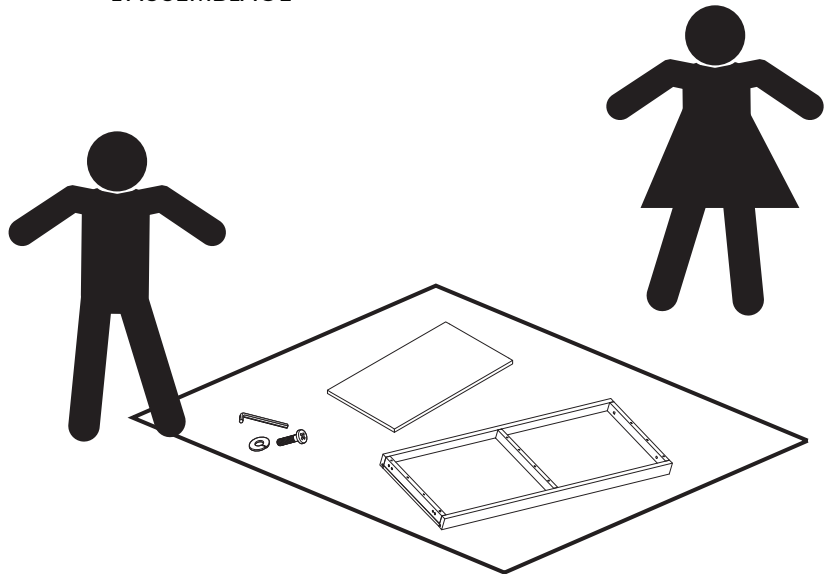
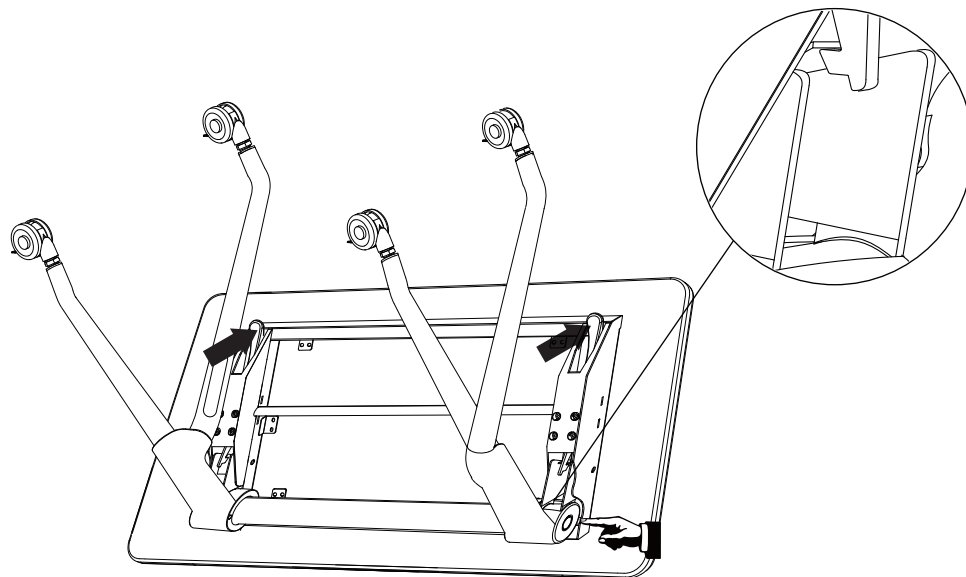
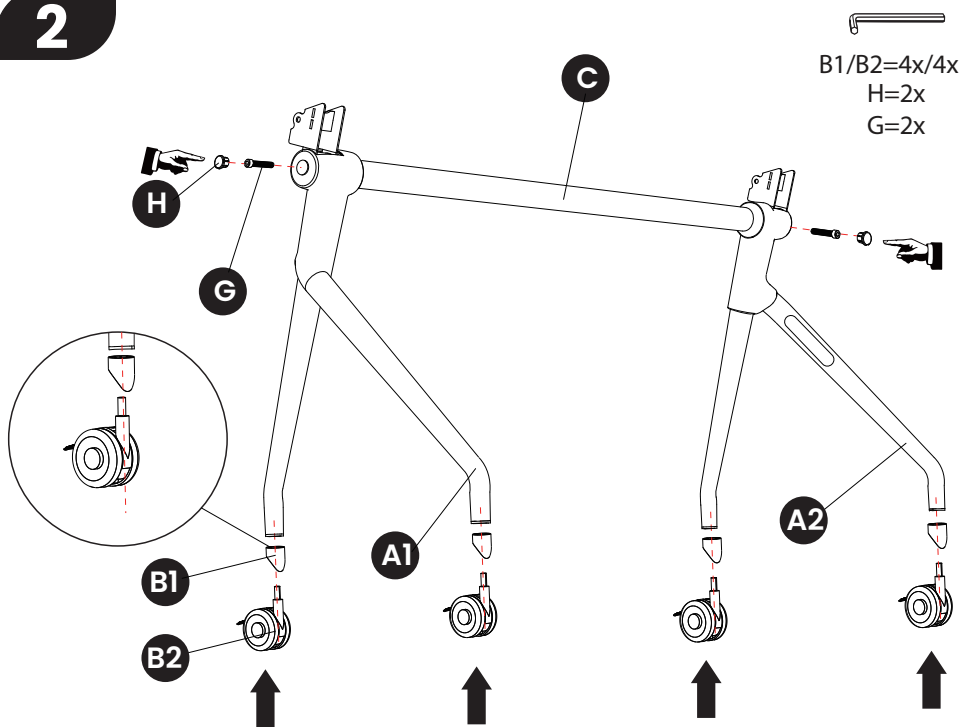
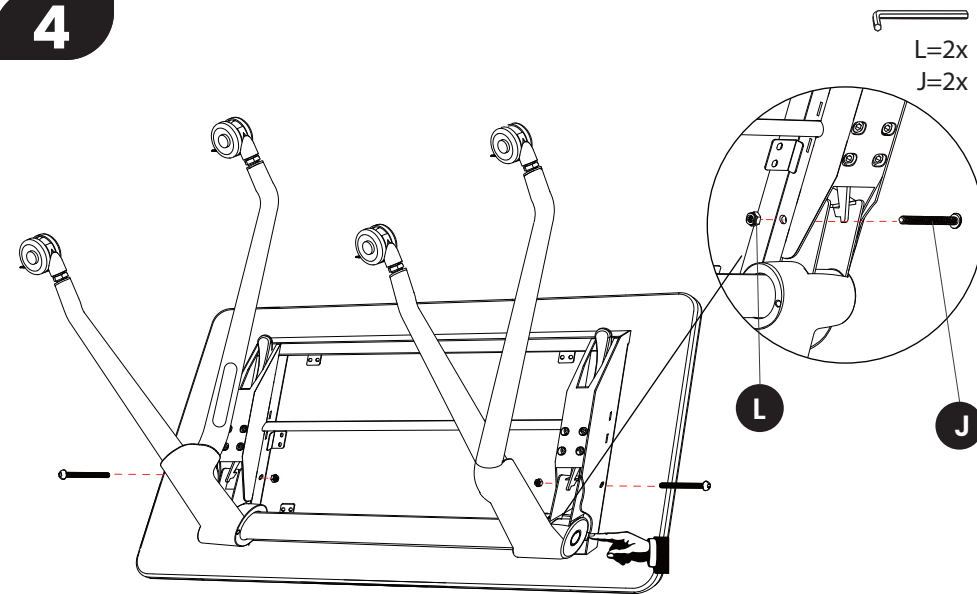
**3****2****4**

5

E=2x  
F=2x  
K=8x

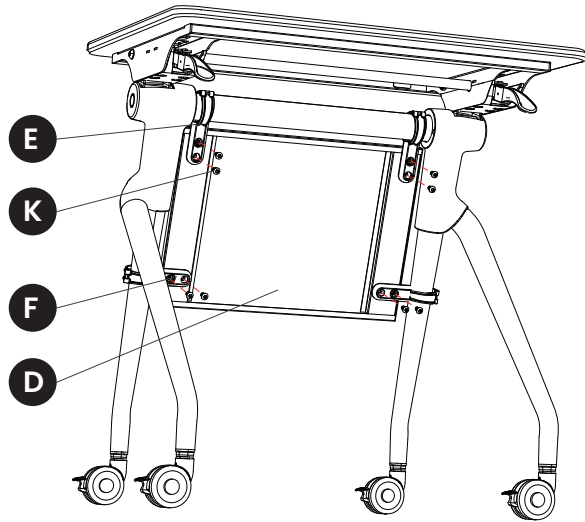

**⚠ WARNING:**

- ▲ May contain small parts, sharp points and edges.
- ▲ Adult assembly required.
- ▲ It is intended for use on a level surface.
- ▲ Adult Supervision Recommended.
- ▲ Check for breakage periodically. Remove the product from service when any condition develops that might deem operation unsafe.

**MADE IN CHINA**

**⚠ ADVERTENCIA :**

- ▲ Puede contener piezas pequeñas, puntas y bordes afilados.
- ▲ Es obligatorio el montaje por parte de un adulto.
- ▲ Está destinado para su uso en una superficie nivelada.
- ▲ Se recomienda la supervisión de un adulto.
- ▲ Verifique las roturas periódicamente. Retire el producto cuando aparezca alguna condición por la que pueda considerar que no es seguro operarlo.

**HECHO EN CHINA**

**⚠ AVERTISSEMENT :**

- ▲ Risque de contenir de petites pièces, des pointes et des bords coupants.
- ▲ Le montage doit obligatoirement être effectué par un adulte.
- ▲ Il est destiné à être utilisé sur une surface plane.
- ▲ La supervision par un adulte est recommandée.
- ▲ Contrôlez régulièrement l'usure. Retirez le produit dans les cas présentant des risques d'utilisation.

**FABRIQUÉ EN CHINE**

**CARE AND CLEANING:**

**Care:** Check for loose or worn parts periodically and tighten or replace as necessary.

**Cleaning:** Use a clean, damp cloth or sponge with mild soap, non-bleach detergent or general purpose cleaner.

**CUIDADO Y LIMPIEZA:**

**Cuidado:** Revise las piezas sueltas o gastadas periódicamente y apriete o reemplace según sea necesario.

**Limpieza:** Use un paño limpio y húmedo o una esponja con jabón suave, detergente sin lejía o un limpiador de uso general.

**ENTRETIEN ET NETTOYAGE :**

**Entretien :** Vérifiez régulièrement les pièces détachées ou usées et si nécessaire, resserrez-les ou remplacez-les.

**Nettoyage :** Utilisez un chiffon ou une éponge propre et humide avec un savon doux, un détergent sans javelissant ou un nettoyant tout usage.

6

