

88 6000 80 Arm Chair

IMPORTANT NOTE

Carefully remove all the parts from the carton and put them individually on a soft cloth to prevent scratches or other damage occurring to the parts.

We have taken great care in the design of this product and request that you carefully and strictly follow our assembly instructions to ensure a completed product as it was designed.

*Home
Styles*

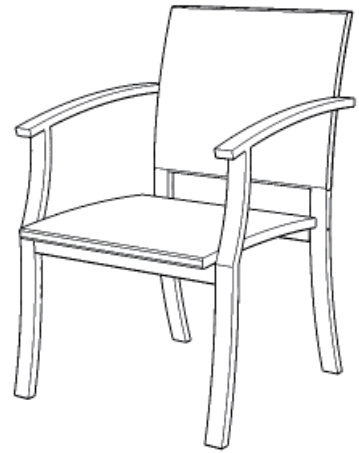

Part List

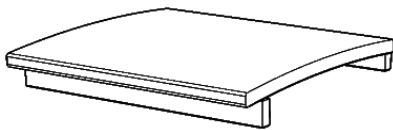

**A.
Seat**
1 Pc.

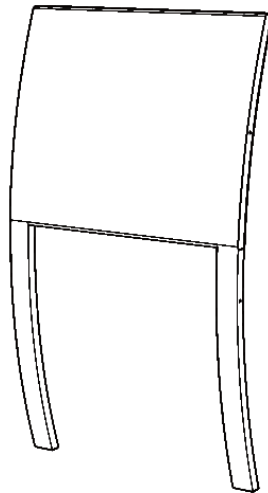

**B.
Back Frame**
1 Pc.

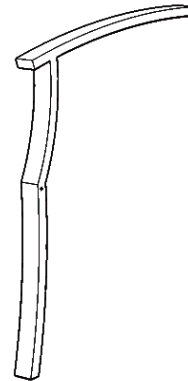

**C.
Leg**
1 Pc.

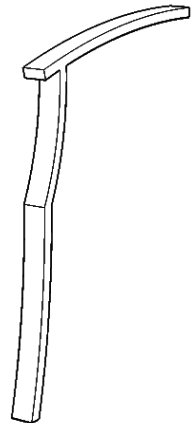

**D.
Leg**

Hardware List

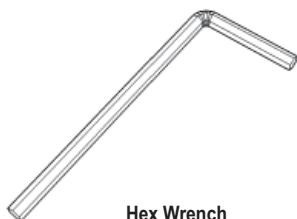

Hex Wrench
1 Pc.



**Small
Hex Wrench**
1 Pc.

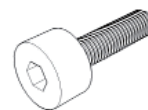

**M6x25
Head Cap Bolt**
6 Pcs.(+1 extra)



Plastic Cap
6 Pcs.(+1 extra)

Assembly Instructions 2/2

IMPORTANT

* Please keep Hex Wrench in a safe place as you may need to tighten up the Head Cap Bolts in the future.

STEP 1

Attach Seat (A) to Back Frame (B) with Head Cap Bolts.

Tighten all Bolts with Hex Wrench.
(See Figure 1)

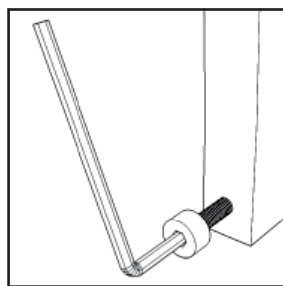
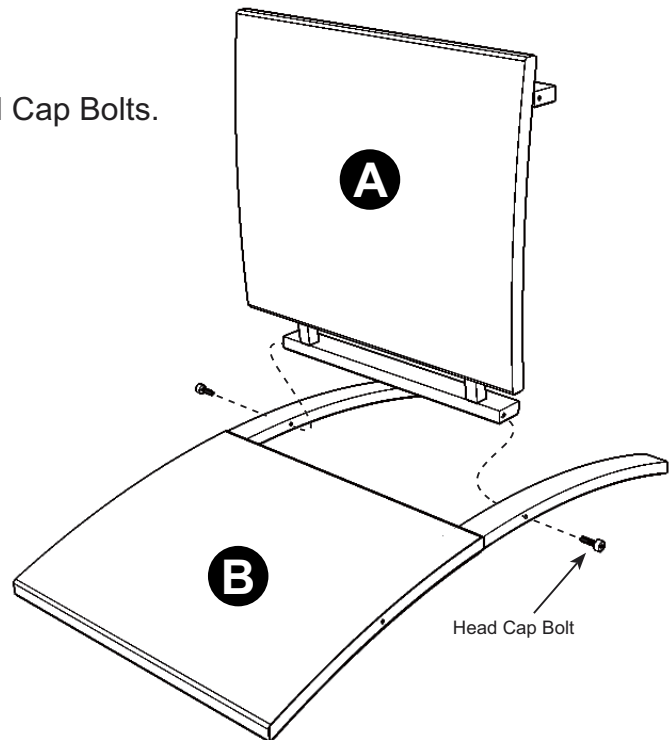

Figure 1



STEP 2

Attach Leg (C) and Leg (D) to unit with Head Cap Bolts.

Turn the Chair to its' upright position.

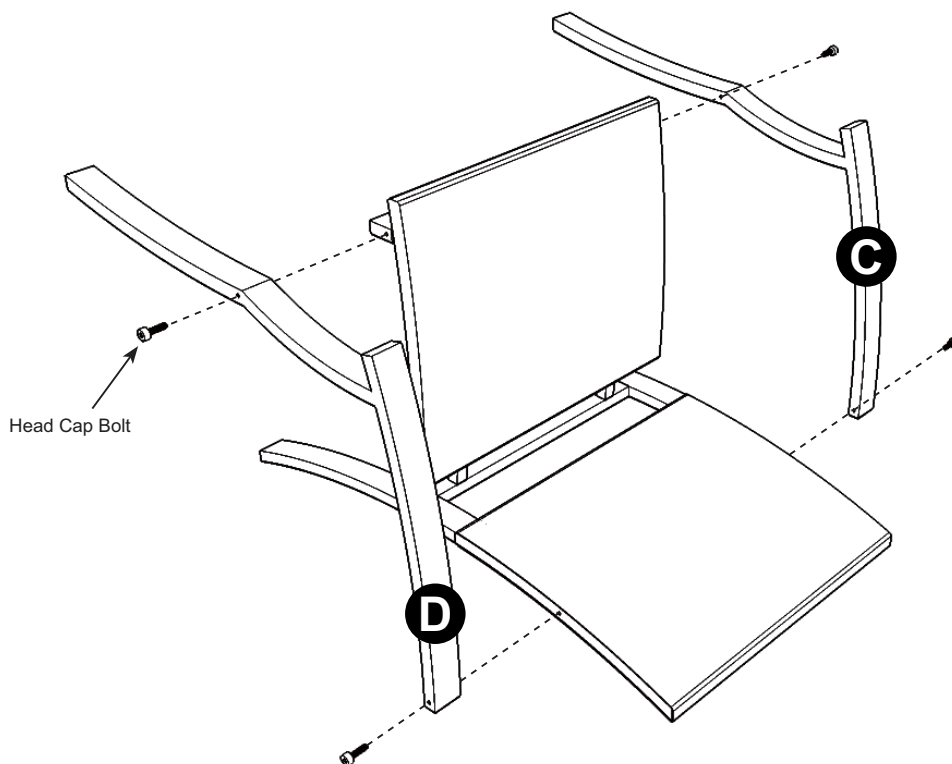

STEP 3

Cover all holes with Plastic Caps.
(See Figure 2)

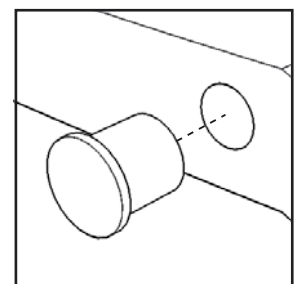

Figure 2