







# ASSEMBLY INSTRUCTION

ITEM: 7050-50001-02 Floor Mirror  
7050-50001-89 Floor Mirror

Thank you for purchasing this quality product. Be sure to unpack carefully looking for small parts which may have come loose during shipment.

Read all instruction and study the drawing carefully before starting the assembly process.

HARDWARE PACK				
NO.	DRAWING	DESCRIPTION	SIZE	Q'TY
A		Allen Wrench	73*29*5mm	1 PC
B		Bolt	Ø5/16"	4 PCS
C		Lock Washer	Ø5/16"	4 PCS
D		Flat Washer	Ø5/16"	4 PCS

PARTS LIST			
NO.	DRAWING	DESCRIPTION	Q'TY
1		Mirror	1 PC
2		Leg	2 PCS

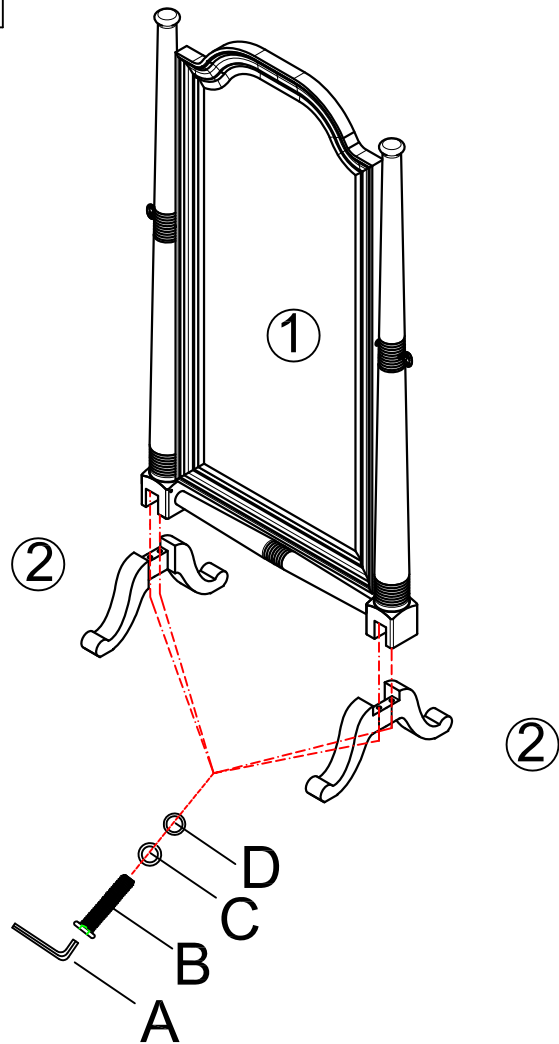
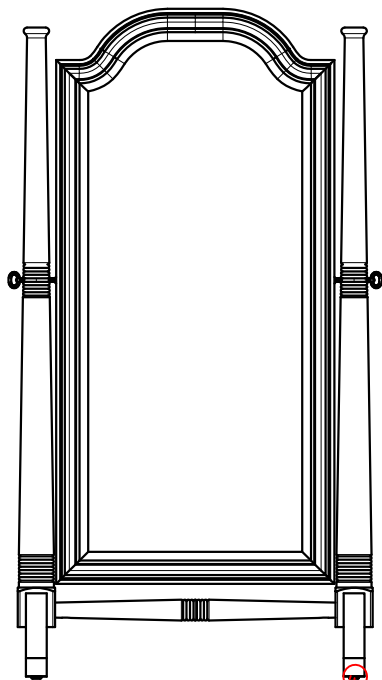

**Step 1:**  
Attach legs (2) to mirror (1) by using flat washers (D), lock washers (C) and bolts (B), then tighten them securely with allen wrench (A).

**Step 2:**  
Adjust leveler if needed to level mirror on uneven floor.