

ANZZI®

ITEM: BA-LMDFX022AL  
FRONT & BACK LIGHTING LED MIRROR  
INSTALLATION & OPERATION MANUAL

V1.0  
01/26/2023



# DON'T WAIT! REGISTER NOW!

Register your product within 90 days to ensure your product is recognized as an official purchase and is eligible for warranty coverage.

Mail in the completed registry card (Pg. 2) or register online at [www.swcorp.com/register](http://www.swcorp.com/register).



# PRODUCT REGISTRATION\*

**IMPORTANT: YOUR WARRANTY WILL NOT BE RECOGNIZED UNLESS THIS CARD IS FULLY COMPLETED AND RETURNED OR ONLINE REGISTRATION IS COMPLETED.**

To ensure that your warranty is registered and confirmed please do one of the following:

1. Register online at [www.swcorp.com/register](http://www.swcorp.com/register). You will be asked to fill out the same information you would in the registration card. Registering online is fast, secure and ensures we receive your information.
2. Complete, cut out and mail the registration card below. By returning this registration card we confirm the date of purchase for your new product. This confirmation will allow us to process any warranty claims.

**Mail the card to: 5701 NW 35 Avenue, Miami, FL 33142**



### Product Registration Card

Name..... Address .....

City..... State..... Zip.....

Phone ..... Email.....

Date of Purchase ..... Order or Purchase # ..... SKU or Model # .....

Installer's Name ..... Phone .....

I have read the Owner's Manual carefully and understand and agree that any installation, operation or maintenance of the product must be done strictly in accordance with instructions and guidelines contained in the owner's manual and installation guide.

Signature..... Date.....

**Need help? For technical support call 305-614-4070 or visit us at [www.ANZZI.com](http://www.ANZZI.com)**

# PRODUCT SIZE CHART

BA-LMDFX022AL 48" \* 30"

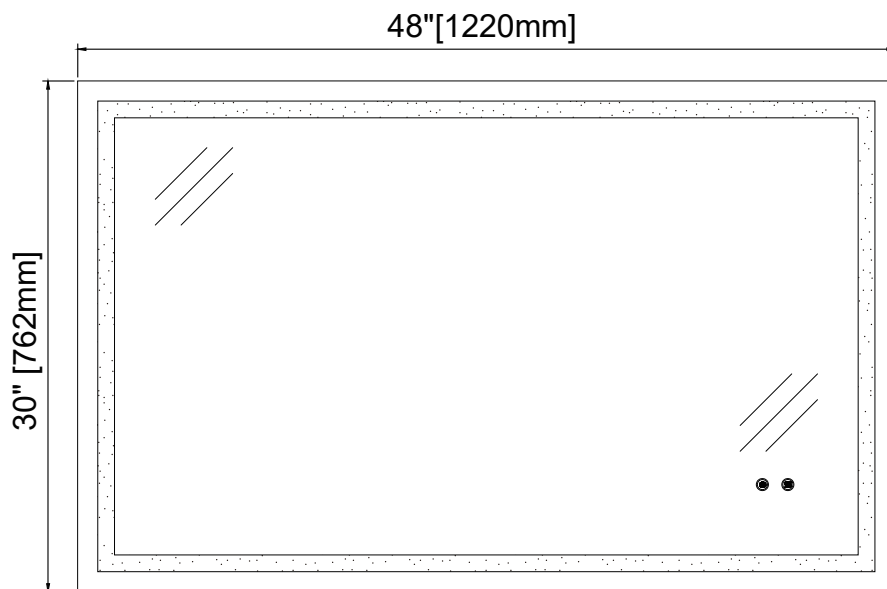

## MOUNTING DIMENSIONS

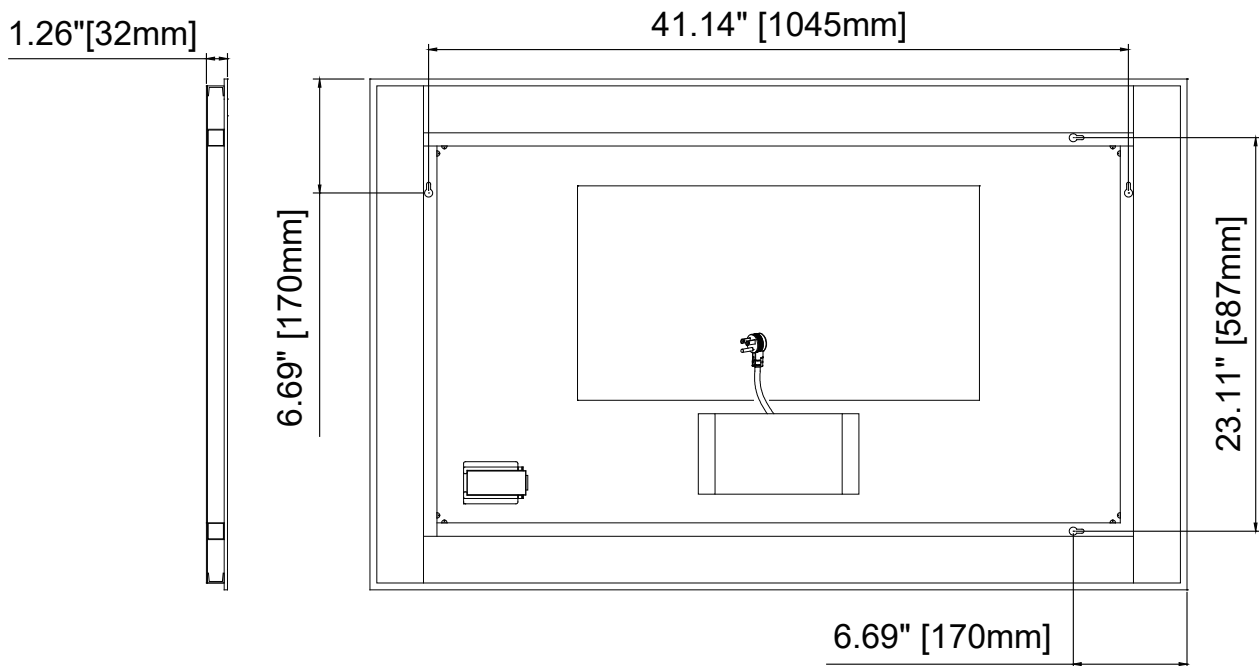

# INSTALLATION INSTRUCTIONS

For the style of LED Mirror shown below

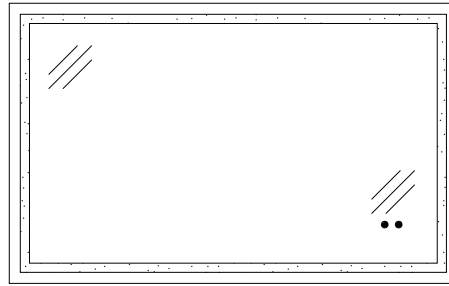

- Please read carefully and save these instructions.
- Don't discard any of the packaging until you are sure that you have all of the parts and the fittings.

## **DANGER**

- **Make sure power to the junction box or outlet is off before commencing installation.**
- **Always unplug the mirror from the outlet or turn off the switch before cleaning or servicing to reduce the risk of electric shock.**

## **WARNING**

- DO NOT lay mirror on tiled or concrete surface prior to installation.
- Mirror must be on protected surface to prevent chipping of the corners.
- We highly recommend you have your mirror professionally installed if you are not familiar with basic plumbing and electricity. DO NOT attempt to install, repair or disassemble the LED mirror without first disconnecting the electricity.
- When drilling pilot holes, be careful to avoid any wiring or pipe work that may be concealed behind the wall.
- The mirror must be connected to a GFCI outlet.
- Risk of Electric Shock, Fire, and Injury.
- Keep the cord away from heated surfaces.
- Risk of Electric Shock – Connect this mirror to a properly grounded outlet only. See Grounding Instructions.
- This product must be connected to a grounded metal, permanent wiring system, or an equipment-grounding conductor must be run with the circuit conductors and connected to the equipment-grounding terminal or lead on the product.
- Never operate this mirror if it has a damaged cord or plug, if it is not working properly, if it has been dropped or damaged, or dropped into water. Return the mirror to a service center for examination and repair.
- Do not operate where aerosol (spray) products are being used or where oxygen is being administered.
- To disconnect, turn off mirror and unplug power cord from outlet.
- Review the assembly instructions to confirm that the correct components and accessories are being used with the mirror.
- Close supervision is necessary when this mirror is used by or near children, invalids, or disabled persons.
- Do not use outdoors.

# INSTALLATION INSTRUCTIONS

## ATTENTION

- Handle the glass with caution! Improperly handling the glass can cause it to break.
- You will need at least two people to install this unit properly.
- Inspect all parts for damage; if there is damage to the unit prior to installation, please contact customer service at the number provided in this guide.
- Make sure that the electricity is turned off at the power source before proceeding with the installation or cleaning.
- Always unplug the power supply cord from the outlet before moving the product, testing the product, or repairing the product.
- The defogger operates only when the LED light is turned on.
- Use this mirror only for its intended use as described in these instructions. Do not use attachments that are not recommended by the manufacturer.
- **Statement: ANZZI does not assume any responsibility for the losses caused by the improper installation and behavior listed above or other improper operations.**

## TOOLS REQUIRED

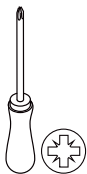

Phillips  
Screwdriver



Level

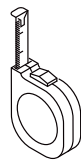

Tape  
Measure

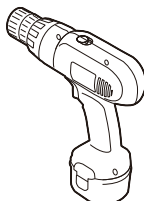

Drill



1/8"  
(3mm)  
Drill Bit

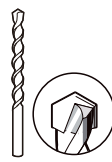

5/16"  
(8mm)  
Drill Bit



Pencil



Rubber  
Mallet



Safety  
Glasses

# INSTALLATION INSTRUCTIONS

1

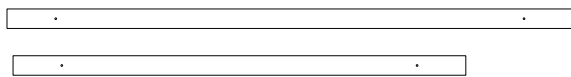
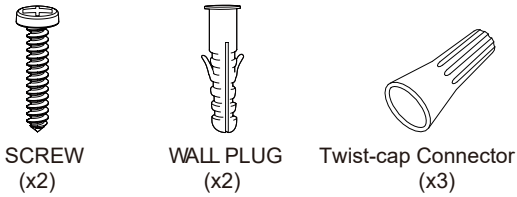
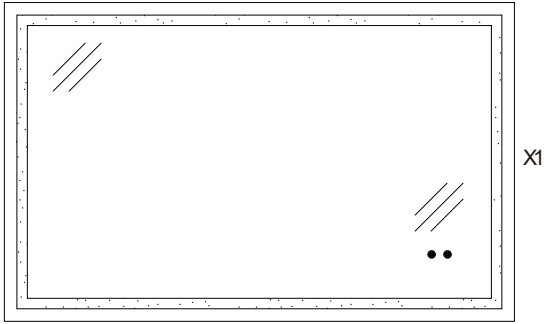

Position Template x2  
(Vertical and horizontal mount options)

2

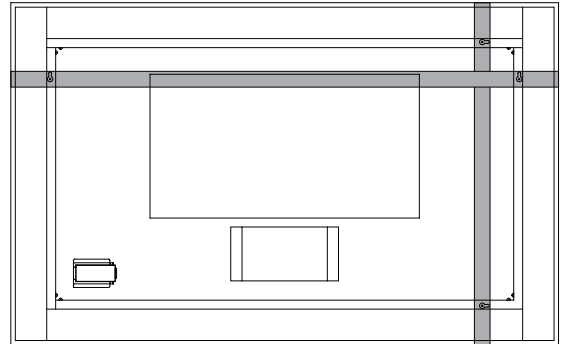

This mirror can be hung horizontally or vertically.  
Make sure to use the right template.

3

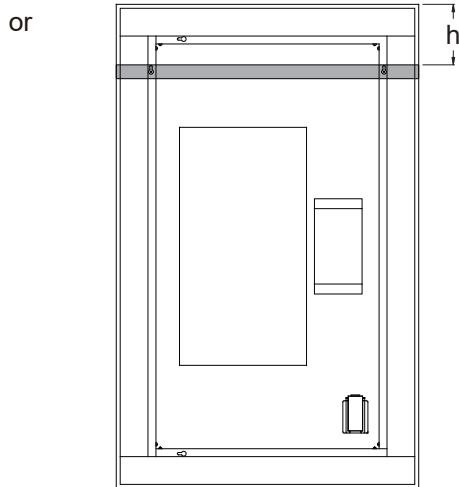
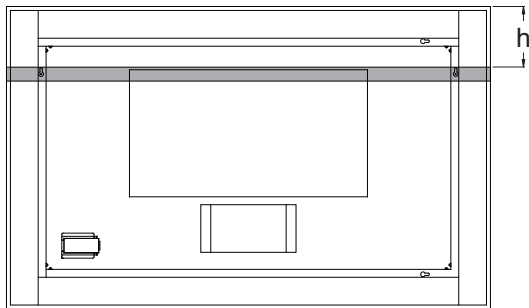

Measure the distance "h" from the Position Template to the top of the product.

4

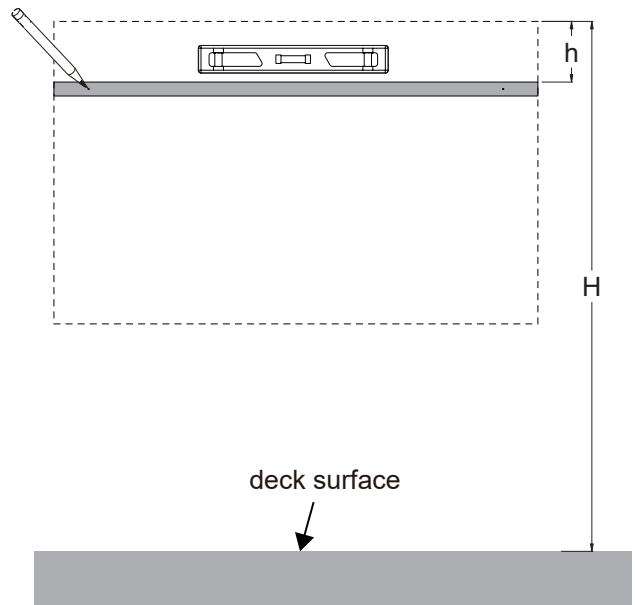

According to the height "H" of the product, place the Position Template horizontally on the wall and mark the installation holes with pencil.  
For exact distance, reference the Mounting Dimensions figure on page 1.

# INSTALLATION INSTRUCTIONS

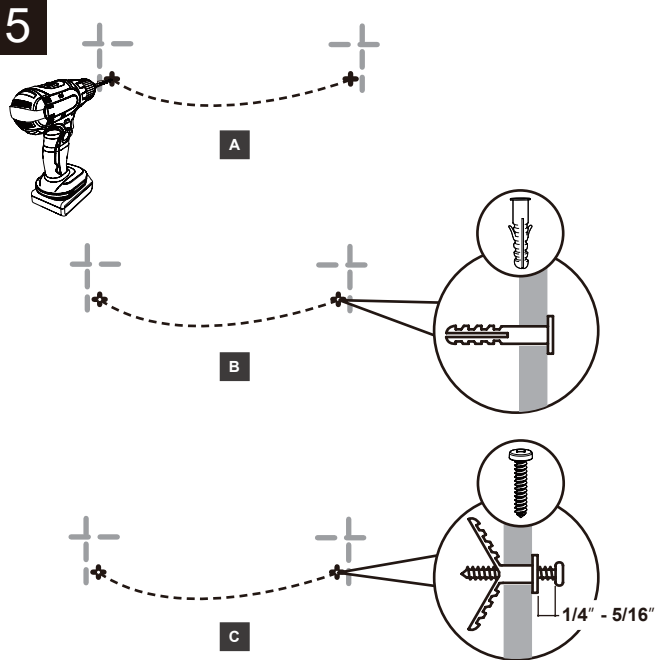

If drilling into wood, drill a 1/8" hole at each marked location (figure A) and install screws into holes. If drilling into concrete, drill a 5/16" hole at each marked location (figure A, B, C), insert wall plugs, and install screws into the wall plugs. Leave a gap of 1/4"-5/16" between the screw head and the wall.

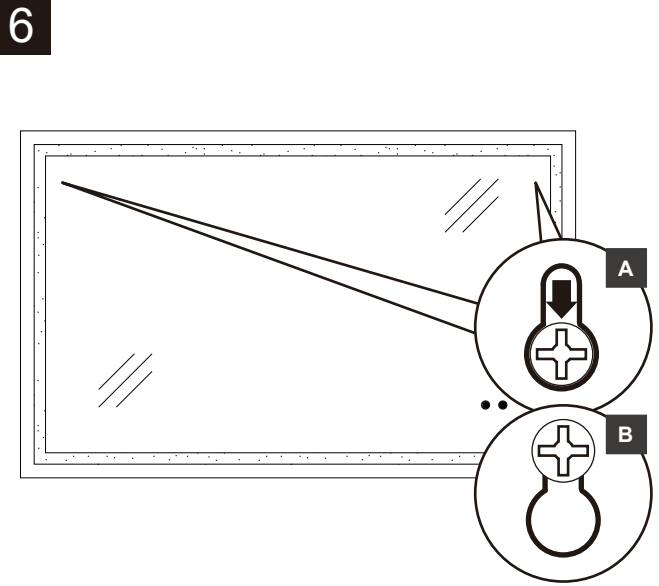

The LED mirror is provided with a power supply cord. For the plug-in connection, place the mirror against the wall and slide down as shown. Then plug the power supply cord into the outlet to finish the installation. For the wire connection, please cut the power supply cord near the plug and connect the wire by following step 7. Then secure mirror by following step 6.

### 7

#### WIRING DETAILS

INCOMING SUPPLY	MIRROR WIRING
SWITCHED LIVE ——— L ———	BLACK or LABELED - L
EARTH (GREEN/YELLOW SLEEVED COPPER) ———  ———	GREEN - E
NEUTRAL ——— N ———	WHITE or LABELED - N

**LED Mirror Cable**

**Before starting the wire connection, please make sure the electricity supply has been turned off.**

For the wire connection, please cut the power supply cord and strip a section of sheath and insulation from the cable. Connect the neutral (N) and live (L) wires to the mirror's power supply wires, using the Twist-cap Connectors. Connect the mirror's green wire to the grounding wire in the junction box with a Twist-cap Connector. Carefully push the wires into the junction box.

# OPERATION

Turn on the power supply before you use the mirror.



Press this key to turn the LED light on or off. Press and hold to change the color temperature from 2700-6500k. It will change gradually(2700-6500k).



Press this key to turn the defogger on or off. Press and hold to change the brightness from 10%-100%. It will change gradually (10%-100%).

# MAINTENANCE

Wipe clean with a soft damp cloth. Apply glass cleaner to cloth and do not apply directly to mirror. An occasional wiping down with a mild soap diluted in water is all that is needed to keep the mirror and aluminum parts looking new. Never use abrasive cleaners as these could damage the finish or exposed LED strips. Never use scouring powder pads, abrasive material, strong bleach or sharp instruments on metal components or glass. Test products on a small inconspicuous surface prior to use.



ANZZI®