

Panel Description

XT-HDBT-MX44-4K Front Panel

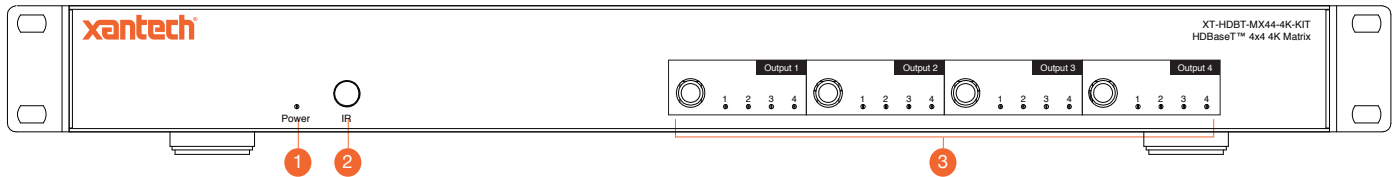

- 1 IR receiver window for matrix control
- 2 Power LED indicator - indicates if the unit is on or off
- 3 HDMI output selection buttons 1-4. Press to scroll through source inputs per HDMI output

XT-HDBT-MX44-4K Rear Panel

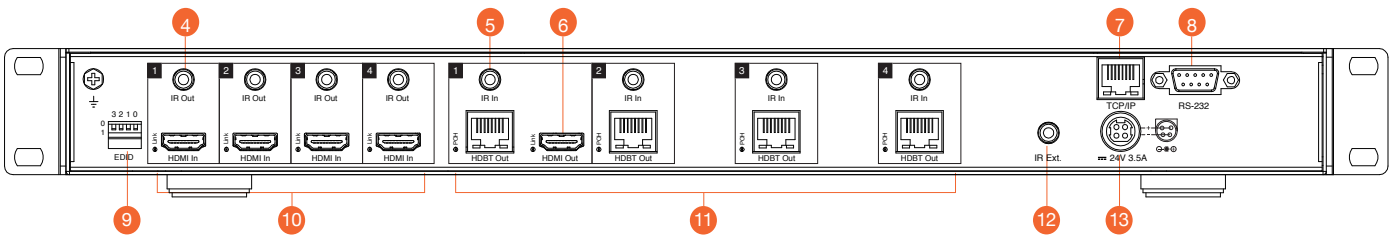

- 4 IR output - connect to Xantech IR emitter for source control from HDBT receivers
- 5 IR input - connect to Xantech IR receiver to transmit IR to HDBT receivers
- 6 HDMI output - connect to a HDMI display
- 7 TCP/IP (RJ45) – connect to LAN for TCP/IP control of Matrix
- 8 RS-232 Serial port for control by third party control devices
- 9 EDID DIP switch used to adjust HDMI input EDID settings
- 10 HDMI inputs - connect to HDMI source devices
- 11 HDBT output - RJ45 connector, connect to XT-HDBT-EX70-4K-RX receivers
- 12 IR input for matrix control
- 13 Power port - use included 24V/3.5A DC power adaptor

XT-HDBT-EX70-4K-RX



- 16 HDMI Link LED - LED will be lit when an active HDMI connection is detected.
- 17 HDMI Output - Connect to the HDMI input on local display device
- 18 IR input - Connect to Xantech 12V IR Receiver (sold separately). Connection is used extend IR over the HDBaseT signal to control device located at the XT-HDBT-SP14-4K splitter.
- 19 IR output - Connect to Xantech 12V Emitter (sold separately). Connection is used to control the local source or display device from Xantech IR Receiver connected at the XT-HDBT-SP14-4K splitter.
- 20 Power LED indicator.
- 21 Power port - Connect Xantech 12V DC power supply only. Note - HDBaseT extender kit can be powered from either the Transmitter or Receiver by using the power over cable (POH) feature.
- 22 HDBaseT input - RJ45 connector. Connect to HDBaseT output on XT-HDBT-SP14-4K splitter.
- 23 HDBaseT Link LED - LED will be lit when an active connection is established with the XT-HDBT-SP14-4K.

Adjusting The EDID Settings

EDID (Extended Display Identification Data) is a data structure that is used between a display and a source. This data is used by the source to find out what audio and video resolutions are supported by the display then from this information the source will discover what the best audio and video resolutions need to be outputted.

While the objective of EDID is to make connecting a digital display to a source a simple plug and play procedure issues do arise when multiple displays or video matrix switching is introduced because of the increased number of variables.

By pre-determining the video resolution and audio format of the source and display device you can reduce the time need for EDID hand shaking thus making switching quicker and more reliable.

Configuration of Matrix EDID settings can be achieved in one of the following ways:-

- 1 Using the EDID dip-switches located on the rear of the Matrix
- 2 Using the Supplied Matrix IR Remote Control
- 3 Using the web browser interface

EDID Dip-switches

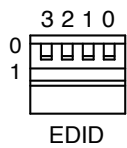

Dip-switch position '0' = Off
 Dip-switch position '1' = On

- [DIP]=0000: HDMI 1080p@60Hz, Audio 2ch PCM
- [DIP]=0001: HDMI 1080p@60Hz, Audio 5.1ch PCM/DTS/DOLBY
- [DIP]=0010: HDMI 1080p@60Hz, Audio 7.1ch PCM/DTS/DOLBY/HD
- [DIP]=0011: HDMI 1080i@60Hz, Audio 2ch PCM
- [DIP]=0100: HDMI 1080i@60Hz, Audio 5.1ch PCM/DTS/DOLBY
- [DIP]=0101: HDMI 1080i@60Hz, Audio 7.1ch PCM/DTS/DOLBY/HD
- [DIP]=0110: HDMI 4K@60Hz 4:2:0+4K@30Hz 4:4:4, Audio 2ch PCM
- [DIP]=0111: HDMI 4K@60Hz 4:2:0+4K@30Hz 4:4:4, Audio 5.1ch PCM/DTS/DOLBY
- [DIP]=1000: HDMI 4K@60Hz 4:2:0+4K@30Hz 4:4:4, Audio 7.1ch PCM/DTS/DOLBY/HD
- [DIP]=1001: HDMI 4K@30Hz 4:4:4, Audio 2ch PCM
- [DIP]=1010: HDMI 4K@30Hz 4:4:4, Audio 5.1ch PCM/DTS/DOLBY
- [DIP]=1011: HDMI 4K@30Hz 4:4:4, Audio 7.1ch PCM/DTS/DOLBY/HD
- [DIP]=1100: DVI 1280x1024@60Hz, Audio None
- [DIP]=1101: DVI 1920x1080@60Hz, Audio None
- [DIP]=1110: DVI 1920x1200@60Hz, Audio None
- [DIP]=1111: Software Control EDID

Remote Control Description

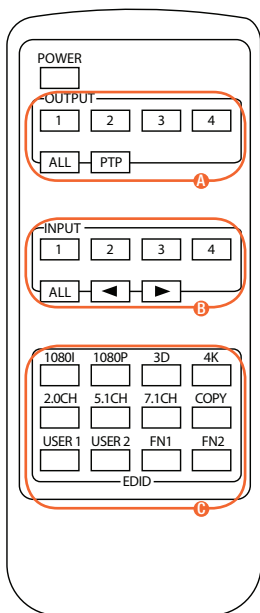

OUTPUT AND INPUT SELECTION

- A** Selects the zone OUTPUT (1 - 4) you wish to change the source on
 - B** Selects the source INPUT (1 - 4) you wish to change on the selected zone
- EXAMPLE:** To switch source 2 to zone 4 you would press Output 4 (A) followed by pressing Input 2 (B).
- ALL button:** The all button selects all the inputs or outputs in its corresponding box. Example: (The "All" button in the Output box selects all the zones so all zones will change to what source input is selected next)
- PTP:** This button will align all zone outputs with the like numbered source inputs. Example: Input 1 to output 1, input 2 to output 2, etc

NOTE: BUTTON PRESS SEQUENCE MUST BE FINISHED IN 5 SECONDS, OTHERWISE THE OPERATION IS DISCARDED

EDID SET UP

- The matrix provides a comprehensive range of EDID settings. Below are three examples of how to deploy the desired EDID setting when using the supplied remote.
- A. Fix EDID to an Input or ALL inputs:** Press the desired video resolution button (1080I / 1080P / 3D / 4K), then select the desired audio format (2.0CH / 5.1CH / 7.1CH), then select the source input you want this EDID information allocated to by pressing the INPUT 1 – 4 or the ALL button
 - B. Copy EDID of Output-X to an Input or ALL:** Press the COPY button then select the OUTPUT you wish to copy the EDID information from, then select the source input you want to copy this EDID to by selecting the INPUT 1-4 or the ALL button.
 - C. User defined EDID to an Input or ALL inputs:** Press USER1 / USER2 button then select the source you wish to assign this EDID to by selecting INPUT 1-4 or the ALL button

Understanding the HDBaseT status lights

Xantech HDBaseT solutions include LED indicators to show connectivity and help diagnose possible problems.

Xantech XT-HDBT-MX44-4K

- The Yellow HDBaseT status link light will be off when the zone output has been turned off or there is a problem with the specific Matrix output.
- The Yellow HDBaseT status link light will blink when the zone output is on and working.
- The Green HDBaseT link light will blink if there is an unstable connection between the Matrix and HDBaseT Receiver.
- The Green HDBaseT link light will be lit when there is an active HDBaseT Receiver connected to the Matrix.
- The Green HDBaseT link light will be off when there is no connection with a HDBaseT receiver.

Xantech XT-HDBT-EX70-4K-RX

- The HDMI link light will be off when there is no connection with a display.
- The HDMI link light will be on when there is an active connection with a display.
- The HDBaseT link light will be off when there is no CAT cable/active HDBaseT connection on the RJ45 HDBaseT input.
- The HDBaseT link light will blink if there is an unstable connection between the Matrix and HDBaseT receiver.

Terminating HDBaseT CAT cable

It is important that the interconnecting CAT cable between the ELAN HDBaseT products is terminated using the correct RJ45 pin configuration. The link CAT cable **MUST** be a 'straight' (pin-to-pin) CAT cable and it is advised that this is wired to the T568B wiring standard as this format is less prone to EMI (Electro-Magnetic Interference).

When installing CAT cables it is advised that you use the best possible CAT cable quality possible. HDMI distribution products will only work if used with CAT5e standard cable or above. ELAN recommends using a CAT6 cable for your installations, especially when running over longer distances, in areas of high EMI, or with 4K signal distribution. It is advised that using any method of patch panel, wall plate or join in the CAT cable is avoided as these will result in HDBaseT signal degradation. ELAN also recommend using the best quality RJ45 connectors possible.

RJ45 Pin-Out T568B

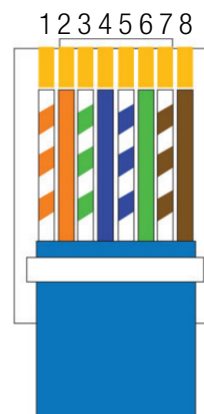
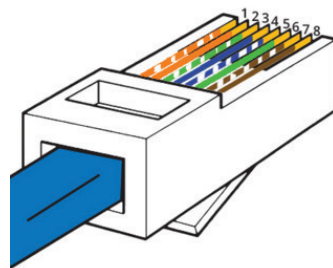

Control Ports

The XT-HDBT-MX44-4K Matrix main communication ports are located on the rear panel and includes the following connections:

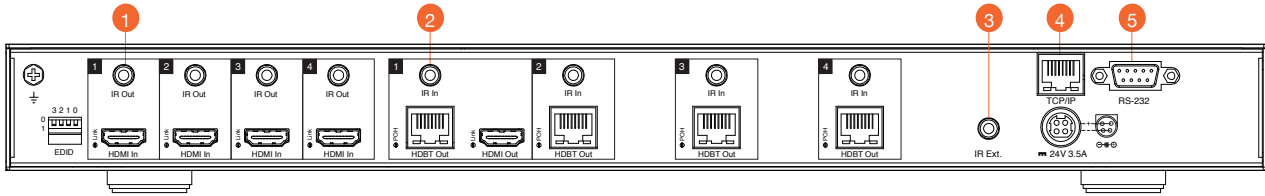

Connections:

- IR output - 3.5mm mono jack provides routed IR emitter
- IR input - 3.5mm stereo jack provides zone specific routed IR receiver input
- IR input for matrix control
- TCP/IP RJ45 socket for Web Interface control
- RS-232 Serial port - For control of switcher by third party control devices

TCP/IP

The XT-HDBT-MX44-4K Matrix can be controlled via TCP/IP. For the full list of protocols please see 'RS-232 and Telnet Commands' located at the rear of this manual. The Matrix features a built-in web browser user interface allowing control and configuration of the matrix. A 'Straight-through' RJ45 patch lead should be used.

RS-232 2-Way

The Matrix can be controlled via a 9-pin serial cable. For the full list of protocols please see 'RS-232 and Telnet Commands' located at the rear of this manual. Details of RS-232 pin assignment and communication are adjacent. Please note that depending on your control device serial port pin configuration you may require either a 'Straight' RS-232 cable or 'Null-modem' type.

Baud Rate: 57600 bps

Data Bit: 8-bit

Parity: None

Stop Bit: 1-bit

Flow Control: None

XANTECH RS-232		REMOTE CONTROL CONSOLE	
PIN	Assignment	PIN	Assignment
1	NC	1	NC
2	Tx	2	Rx
3	Rx	3	Tx
4	NC	4	NC
5	GND	5	GND
6	NC	6	NC
7	NC	7	NC
8	NC	8	NC
9	NC	9	NC

RS-232 and Telnet Commands

The Matrix can be controlled via serial and TCP/IP. The following pages list all available serial commands for the Matrix.

Details of RS-232 pin assignment can be found on the previous page.

Commonly used Serial commands:

There are several commands that are commonly used for control and testing:-

STATUS	Status will give feedback on Matrix such as zones on, type of connection etc
PON	Power on
POFF	Power off
OUTxxON	(xx is the zone number you wish to turn on) Example: - OUT01ON (This would turn output one back on)
OUTxxFRyy	(xx is the zone out, yy is the input) Example: - OUT01FR04 (This would switch output 1 to source input 4)

Common Mistakes

- Carriage return – Some programs do not require the carriage return where as other will not work unless sent directly after the string. In the case of some Terminal software the token <CR> is used to execute a carriage return. Depending on the program you are using this token maybe different. Some other examples that other control systems deploy include \r or OD (in hex)
- Spaces – Blustream commands do not require space between commands unless specified. There may be some programs that require spacing in order to work.
 - How the string should look is as follows OUT01ON
 - How the string may look if spaces are required: OUT{Space}01{Space}ON
- Baud rate or other serial protocol settings not correct

RS-232 COMMAND	DESCRIPTION
?	Print Help Information
HELP	Print Help Information
STATUS	Print System Status And Port State
PON	Power On, System Run On Normal State
POFF	Power Off, System Run On Power Save State
IR ON/OFF	Set System IR Control On Or Off
KEY ON/OFF	Set System Key Control On or Off
BEEP ON/OFF	Set System Deep On Or Off
LED ON/OFF	Set Front Panel LED Always On Or Auto Turn Off In Power On State
RSB X	Set RS-232 Baud Rate to X bps x=[0:115200, 1:57600 2:38400, 3:19200, 4:9600, 5:4800]
RESET	Reset System To Default Setting
RESET ALL	Reset System And Network To Default Configuration (Should Type "Yes" To Confirm, "No" To Discard)
OUT xx ON/OFF	Set Output:xx On or Off
OUT xx FR yy	Set Output:xx From Input:yy xx=00: Select All Output Ports xx=[01...04]: Select One Output Port yy=[01...04]: Select One Input Port
POH xx ON/OFF	Set Output:xx POH On Or Off xx=00: Select All Output Ports xx=[01...04]: Select One Output Port yy=[01...04]: Select One Input Port

RS-232 COMMAND	DESCRIPTION
EDID xx CP yy	Set Input:xx EDID Copy From Output:yy
EDID xx DF zz	Set Input:xx EDID To Default EDID:zz xx=00: Select All Input Port xx=[01...04]: Select One Input Port yy=[01...04]: Select One Output Port zz=00: HDMI 1080p@60Hz, Audio 2CH PCM zz=01: HDMI 1080p@60Hz, Audio 5.1CH DTS/DOLBY zz=02: HDMI 1080p@60Hz, Audio 7.1CH DTS/DOLBY/HD zz=03: HDMI 1080i@60Hz, Audio 2CH PCM zz=04: HDMI 1080i@60Hz, Audio 5.1CH DTS/DOLBY zz=05: HDMI 1080i@60Hz, Audio 7.1CH DTS/DOLBY/HD zz=06: HDMI 1080p@60Hz/3D, Audio 2CH PCM zz=07: HDMI 1080p@60Hz/3D, Audio 5.1CH DTS/DOLBY zz=08: HDMI 1080p@60Hz/3D, Audio 7.1CH DTS/DOLBY/HD zz=09: HDMI 4K@30Hz 4:4:4, Audio 2CH PCM zz=10: HDMI 4K@30Hz 4:4:4, Audio 5.1CH DTS/DOLBY zz=11: HDMI 4K@30Hz 4:4:4, Audio 7.1CH DTS/DOLBY/HD zz=12: DVI 1280x1024@60Hz, Audio None zz=13: DVI 1920x1080@60Hz, Audio None zz=14: DVI 1920x1200@60Hz, Audio None zz=15: User EDID 1 zz=16: User EDID 2 zz=17: GUI Download EDID zz=18: HDMI 4K@60Hz 4:2:0, Audio 2CH PCM zz=19: HDMI 4K@60Hz 4:2:0, Audio 5.1CH DTS/DOLBY zz=20: HDMI 4K@60Hz 4:2:0, Audio 7.1CH DTS/DOLBY/HD
PRESET STATUS	Print Preset Config Status
PRESET pp SET aa,bb,cc,dd	Set Preset:pp Config
PRESET pp SAVE	Save Current Output Connection To Preset:pp Config
PRESET pp APPLY	Apply Preset:pp Config To Output Connection pp=[01..08]: Select Preset Index aa=[01..04]: Output 01 From aa, [00]: Not Set bb: Output 02 ... dd: Output 04
NET DHCP ON/OFF	Set Auto IP(DHCP) ON Or OFF
NET IP xxx.xxx.xxx.xxx	Set IP Address
NET GW xxx.xxx.xxx.xxx	Set Gateway Address
NET SM xxx.xxx.xxx.xxx	Set Subnet Mask Address
NET RB	Set Network Reboot and Apply New Config
NET TN xxxx	Set Telnet Port



Example Schematic
XT-HDBT-MX44-KIT

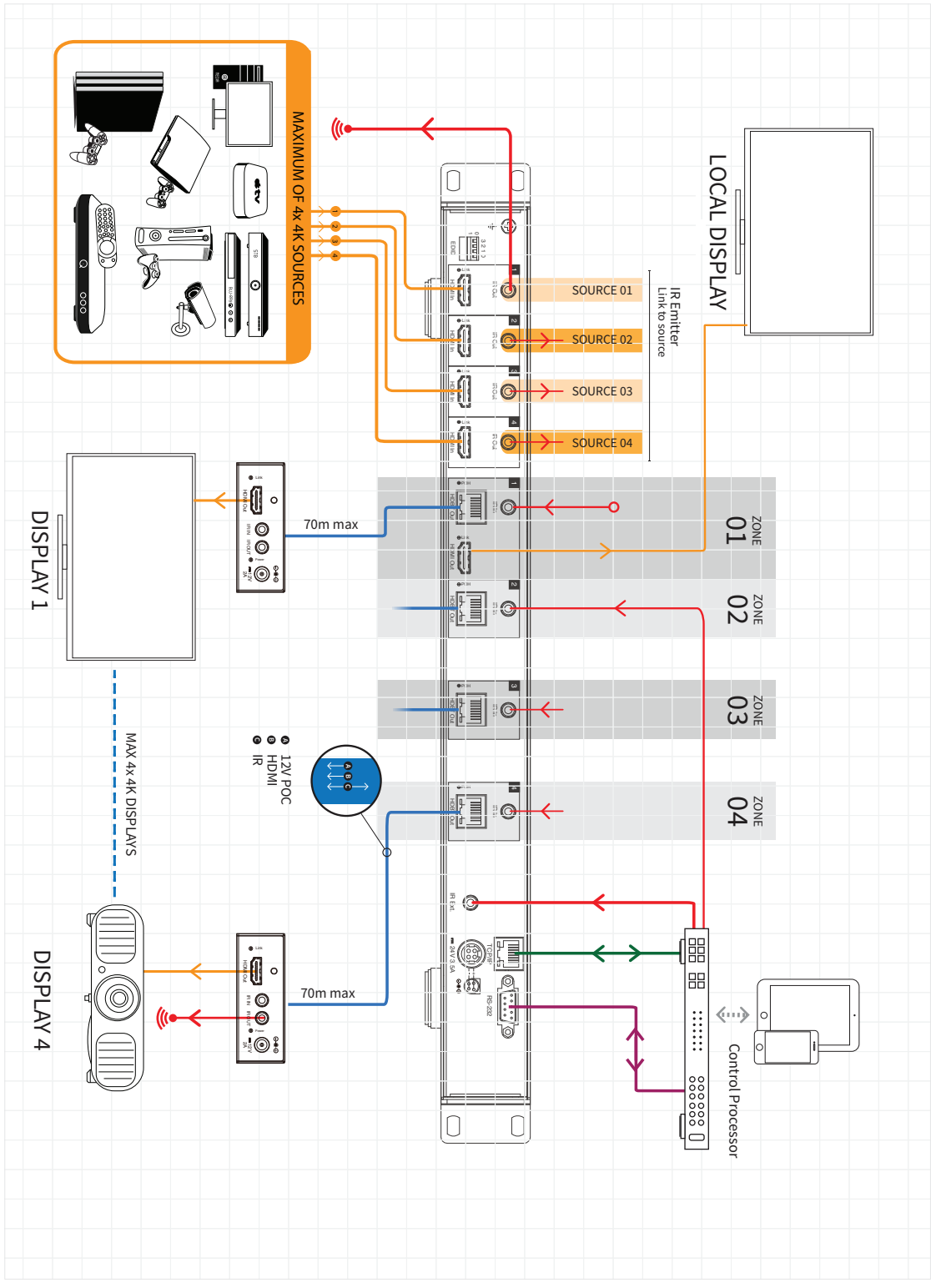
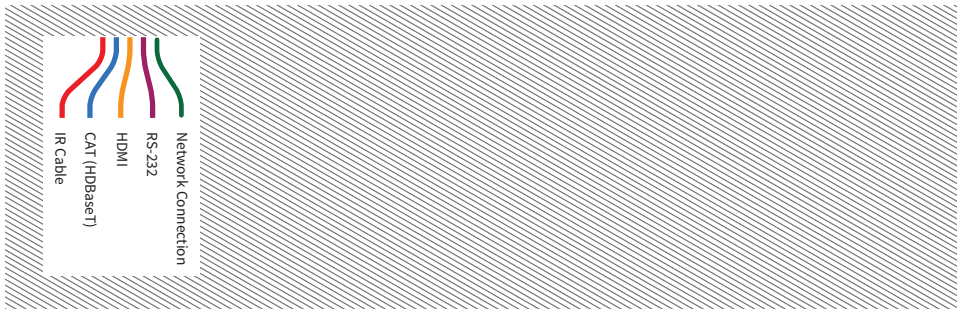

Specifications:

XT-HDBT-SP14-4K

Video Input Connectors: 4x HDMI Type A, 19-pin, female

Video Output Connectors: 1x HDMI Type A, 19-pin, female
4x HDBaseT™ RJ45 connector

RS-232 Serial Port: 1x DB-9, female

EDID: 4-Pin DIP switch

IR Input Ports: 5x 3.5mm stereo jack

IR Output Ports: 4x 3.5mm stereo jack

EDID: 4-Pin DIP switch

Casing Dimensions (W x H x D): 440mm x 201mm x 44mm

Dimensions Inc. Connections (W x H x D): 440mm x 211mm x 52mm

Power Supply : 12V/5A DC

XT-HDBT-EX70-4K-RX

Video Input Connectors: 1x HDBaseT™ RJ45 connector

Video Output Connectors: 1x HDMI Type A, 19-pin female

IR Input ports: 1x 12V 3.5mm stereo jack

IR Output ports: 1x 12V 3.5mm mono jack

Casing Dimensions (W x H x D): 104mm x 27mm x 73mm

Dimensions Inc. Connections (W x H x D): 108mm x 27mm x 73mm

Shipping Weight: 2.7kg

Operating Temperature: 32°F to 104°F (0°C to 40°C)

Storage Temperature : -4°F to 140°F (-20°C to 60°C)

Package Contents:

- 1x XT-HDBT-MX44-4K
- 4x XT-HDBT-EX70-4K-RX
- 4x Mounting kit for XT-HDBT-EX70-RX
- 1x 24V/3.5A DC power supply
- 1x Remote control
- 1x Mounting kit
- 1x Quick reference guide

Certifications

FCC Notice

This equipment has been tested and found to comply with the limits for a Class B digital device, pursuant to part 15 of the FCC Rules. These limits are designed to provide reasonable protection against harmful interference in a residential installation. This equipment generates, uses, and can radiate radio frequency energy and, if not installed and used in accordance with the instructions, may cause harmful interference to radio communications. However, there is no guarantee that interference will not occur in a particular installation. If this equipment does cause harmful interference to radio or television reception, which can be determined by turning the equipment off and on, the user is encouraged to try to correct the interference by one or more of the following measures:

- Reorient or relocate the receiving antenna.
- Increase the separation between the equipment and receiver.
- Connect the equipment into an outlet on a circuit different from that to which the receiver is connected.
- Consult the dealer or an experienced radio/TV technician for help.

CAUTION - changes or modifications not expressly approved by the party responsible for compliance could void the user's authority to operate the equipment.

CANADA, INDUSTRY CANADA (IC) NOTICES

This Class B digital apparatus complies with Canadian ICES-003.

Operation is subject to the following two conditions: (1) this device may not cause interference, and (2) this device must accept any interference, including interference that may cause undesired operation of the device.

CORRECT DISPOSAL OF THIS PRODUCT

This marking indicates that this product should not be disposed with other household wastes. To prevent possible harm to the environment or human health from uncontrolled waste disposal, recycle it responsibly to promote the sustainable reuse of material resources. To return your used device, please use the return and collection systems or contact the retailer where the product was purchased. They can take this product for environmentally safe recycling.

main:
1 (800) 472-5555 - US
1 (707) 283-5900 - International
1 (707) 283-5901 - Fax

tech support:
tech@xantech.com

web:
www.xantech.com