









## Assembly Instructions, #10503 Laurent Condo/apartment Coffee Table

|                       |   |
|-----------------------|---|
| A: Top Assembly       |  |
| B: (4) Legs           |  |
| C: Shelf              |  |
| D: (8) Bolts          |  |
| E: (8) Flat Washers   |  |
| F: (8) Lock Washers   |  |
| G: Allen Wrench       |  |
| H: (4) Shelf supports |  |

### Step 1

Fasten four legs with (8) bolts, flat washers and lock washers.

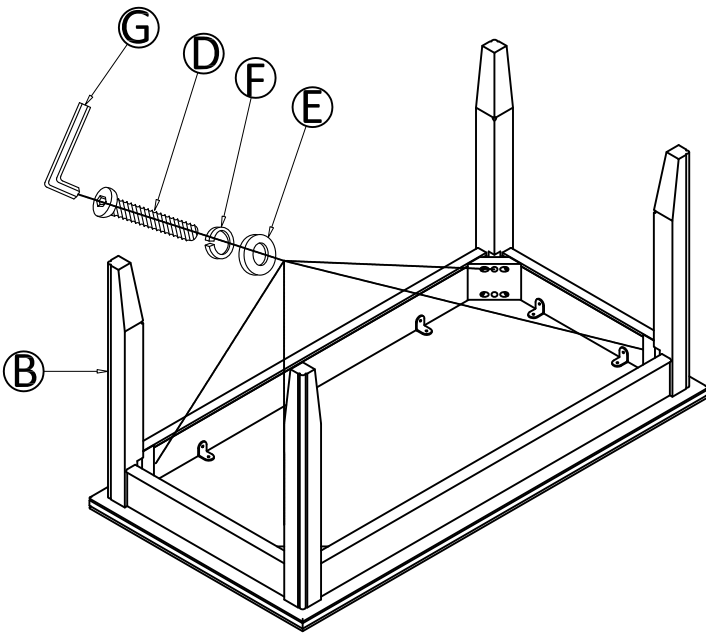

### Step 2

Place table upright and place the shelf onto the shelf supports. It helps to slip the shelf up from the bottom and insert supports from the underneath.

