



NurtureMax™/First Choice™ Infant Car Seat

Owner's Manual

Keep instructions for future use.

Rear-facing with Base*

1.8 to 10 kg
(4 to 22 lbs)

43 to 73 cm
(17 to 29 in.)

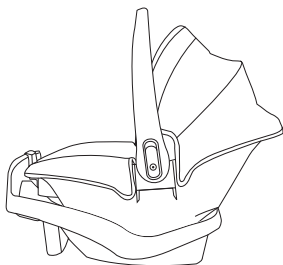

Rear-facing without Base*

1.8 to 10 kg
(4 to 22 lbs)

43 to 73 cm
(17 to 29 in.)

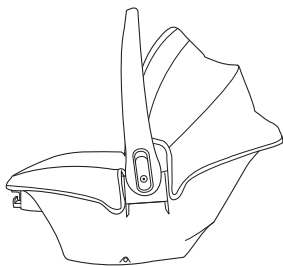

* See page 4 for complete requirements.

Para instrucciones en Español, llamar al:
1-800-233-5921

⚠️ WARNING!

To reduce the risk of serious injury or death, read this owner's manual prior to installing and using this child restraint.

According to the U.S. National Highway Traffic Safety Administration (NHTSA), car seats and boosters provide protection for infants and children in a crash, yet car crashes are a leading cause of death for children.

To reduce the risk of **SERIOUS INJURY** or **DEATH**, read this owner's manual and your vehicle owner's manual before installing and using this child restraint. Using a child restraint makes a big difference. By properly using this child restraint and following these instructions, the instructions on the child restraint, and the instructions that accompany your vehicle, you will greatly reduce the risk of serious injury or death to your child from a crash. Do not be misled by the commonly used term "safety seat"; no restraint system can prevent all injuries in all crashes. Many properly restrained adults and children are injured in motor vehicle crashes, including relatively minor crashes. A properly used child restraint is the best way to minimize injuries to your child and to increase the chances for your child's survival in most crashes.

U.S. REGULATORY NOTICE

This child restraint meets all the requirements of Federal Motor Vehicle Safety Standard 213.

CANADIAN REGULATORY NOTICE (MODEL NUMBERS ENDING IN "C")

This child restraint meets all the applicable requirements of Canada Motor Vehicle Safety Standard CMVSS 213.1.

Symbol Legend



Airbag Symbol – Alerts you to important information about airbag safety.



LATCH/UAS Symbol – Alerts you to important information about **LATCH/UAS** safety.



Aircraft Symbol – Alerts you to important information about aircraft safety.

Table of Contents

Important Information	4
Child Requirements	4
Premature Infant Use	5
Warnings	6
Motor Vehicle/Aircraft Usage	14
Recall Information for U.S. Customers.....	15
Public Notice for Canadian Customers.....	15
Child Restraint Features.....	16
Removing and Storing Lower Anchor Connectors	17
Using the Carrier Handle	18
Proper Installation	
WITH the Base	19
Installing the Base with Lower Anchor Connectors	20
Installing the Base with the Vehicle Seat Belt.....	23
Placing the Carrier in the Base.....	25
Releasing the Carrier from the Base	26
Checklist: Installation with Base	27
Proper Installation	
WITHOUT the Base	28
Installing the Carrier without the Base Using Vehicle Seat Belts	29
Installing the Carrier without the Base Using Lower Anchor Connectors.....	32
Checklist: Installation without Base	35
General Information	36
Securing the Child in the Carrier	36
Removing the Child from the Carrier	38
Changing the Harness Position	40
Changing the Buckle Strap Position	41
Changing the Waist Strap Position	44
Using a Locking Clip.....	46
Using as an Infant Carrier.....	48
Installing the Canopy	49
Removing the Seat Cover.....	50
Replacing the Seat Cover.....	52
Securing Your Child Restraint in Aircraft.....	53
Installing Child Restraint in Aircraft.....	53
Care and Cleaning.....	56
Replacement Parts	57
Proper Disposal of this Child Restraint.....	58
Storing Your Instructions.....	59
Limited Warranty.....	60

Important Information

⚠ WARNING! DEATH or SERIOUS INJURY can occur.

This child restraint is designed for use by children in **rear-facing** orientation only. To use this child restraint properly, children **MUST** meet the size and age requirements below. In addition, Evenflo recommends consulting with your child's physician before allowing your child to transition from a **rear-facing** to **forward-facing** child restraint.

The American Academy of Pediatrics (AAP) recommends keeping children **rear-facing** for as long as possible, until they reach the maximum height or weight for their child restraint in **rear-facing** orientation.* Additionally, some states' laws require children to be **rear-facing** until age 2. Accordingly, you will see this guidance reflected in the Child Requirements on the following pages. Please review any applicable local, state or provincial laws related to child passenger safety before installing and using this Car Seat.

*Pediatrics. 2018;142(4):e20182460

Child Requirements

- 1.8 to 10 kg (4 to 22 lbs)
- 43 to 73 cm (17 to 29 in.) and top of child's head is at least 2.5 cm (1 in.) below the top of the child restraint seat back (see pages 19 and 28).



IMPORTANT: Once your child exceeds any of the size requirements above, you **MUST** discontinue use of this child restraint.

Premature Infant Use

Before using this child restraint for preterm or low birth weight infants, ensure the Child Requirements are met and follow the guidelines in this section.

According to NHTSA, a properly installed Child Restraint reduces the risk of death by over 70% for infants involved in crashes. Federal Motor Vehicle Safety Standard (FMVSS) 213 establishes design and dynamic performance requirements for Child Restraint systems. However, the standard has no minimum weight limit and does not address the special medical needs of preterm or low birth weight infants. To ensure that preterm and low birth weight infants are transported safely, the guidelines published by the American Academy of Pediatrics (AAP) in Pediatrics 2009;123:1424–1429 (reaffirmed June 2018) must be followed.

Preterm and low birth weight infants are at additional risk of breathing difficulties and heart problems when placed in a Child Restraint. Evenflo requires that the evaluation recommended by the AAP be conducted for all infants born earlier than 37 weeks and all newborn infants who weigh less than 2.26 kg (5 lbs) at birth before their first car trip to check for breathing difficulties or heart rate problems when traveling in a **rear-facing** Child Restraint. Newborn infants should **NEVER** travel in a **forward-facing** Child Restraint.

The AAP recommends that appropriate hospital staff observe your infant in the Child Restraint for a period of 90 to 120 minutes or the duration of travel, whichever is longer. This period of observation must be performed with the infant properly positioned as described in these instructions and with the Child Restraint placed at an angle that is approved for use in the vehicle. The hospital staff will check for any breathing difficulties or heart rate problems. Your child's pediatrician will let you know if there are any special considerations for travel. The number of trips and the duration of time the infant is seated in the Child Restraint should be minimized. A caregiver should ride in the back seat to monitor the infant during travel.

You can learn more about the AAP's recommendations as well as other resources for parents and medical professionals, at <https://www.healthychildren.org/english/safety-prevention/on-the-go/Pages/default.aspx>

WARNING! DEATH or SERIOUS INJURY can occur.

General Warnings

- Failure to follow the Child Requirements for use of this child restraint could result in serious injury or death. (See page 4 for Child Requirements).
- Child Restraints should be used only for travel. Potential adverse health effects from excessive use of infant child restraints have been documented. You should limit the time spent each day in a child restraint as much as possible. You must **NEVER** use your child restraint as a sleeping environment in the home. **NEVER** leave your infant unattended in a child restraint in or out of the vehicle.
- Failure to follow installation instructions and the instructions and warnings on the product can result in your child striking the vehicle's interior during a sudden stop or crash. Serious injury or death may result. These instructions and the instructions in your vehicle owner's manual must be followed carefully. If there is a conflict between the two, the vehicle owner's manual regarding child restraint installation must be followed.
- This child restraint **MUST ALWAYS** face the rear of the vehicle. Serious injury or death can occur.
- **NEVER** leave child unattended.
- **DO NOT** use child restraint if it is damaged, broken, or missing parts.
- **DO NOT** use this restraint if it has been involved in a crash. It must be replaced.
- **DO NOT** attach additional padding, toys or other devices not made by Evenflo, or described in these instructions, to the child restraint. Items not tested with the child restraint could injure the child.
- Be sure that the handle is firmly locked in **Position 1** before lifting the child restraint (see "Using the Carrier Handle" on page 18).
- This child restraint must be securely belted to the vehicle at all times, even when unoccupied. An unsecured child restraint may injure someone if a crash occurs.
- **NEVER** use child restraint without the seat pad.

⚠ WARNING! DEATH or SERIOUS INJURY can occur.

Airbag Warnings



- **DO NOT** place rear-facing child seat on front seat with air bag. **DEATH OR SERIOUS INJURY CAN OCCUR.** The back seat is the safest place for children 12 and under.
- **DO NOT** use this child restraint in the front seat of a vehicle equipped with an air bag, unless the air bag has been deactivated. Interaction between a rear-facing restraint and air bags may cause serious injury or death. Air bags may cause serious injury or death to children 12 years of age and under. If your vehicle has an air bag, refer to your vehicle owner's manual for child restraint installation.
- If the rear seat of your vehicle is equipped with side air bags, refer to the following information for proper usage:

Vehicles built prior to the 2002 model year:

DO NOT use this restraint in a vehicle seating position equipped with a side air bag unless authorized by the vehicle manufacturer.

Model year 2002 and newer vehicles:

Refer to your vehicle owner's manual before placing this restraint in a seating position equipped with a side air bag. **DO NOT** place any objects between the restraint and the side air bag, as an expanding air bag may cause the items to strike your child.

The forward-facing rear seat is the safest place for children 12 and under.

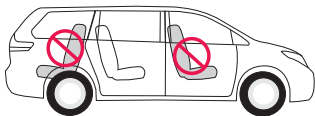
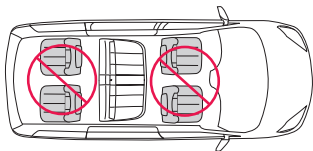

! WARNING! DEATH or SERIOUS INJURY can occur.

Location Warnings

- **ALWAYS** read and follow exactly the instructions that accompany your vehicle and child restraint.
- According to accident statistics, children are safer when properly restrained in a rear seating position than in a front seating position. Generally, the center rear is safest and should be used if available. Children 12 and under should ride in the back seat of the vehicle.
- If you are unable to use the center rear seating position and have to install this child restraint directly behind a front vehicle seat, ensure that there is at least 38 mm (1.5 in.) of space between any part of the child restraint and the vehicle seat that is closest to the child's head. This space may be necessary for the child restraint to properly perform in certain types of crashes.
- **ONLY** use this child restraint on **forward-facing vehicle seats**. **DO NOT** use on vehicle seats which face the rear or side.
- **ONLY** use this child restraint on vehicle seats with backs that lock into place.
- Some child restraints do not fit all vehicles or all seating locations. There are thousands of combinations of vehicle makes, models, child restraint configurations, seat belt designs and seat cushion shapes. The easiest way to determine whether your child restraint is suitable for a particular seating position is to check for a tight installation. If the child restraint cannot be properly installed, **DO NOT** use this child restraint. Consult vehicle owner's manual, try a different seating location, or call Evenflo at 1-800-233-5921 (U.S) or 1-937-773-3971 (Canada).



VEHICLE TYPES IN WHICH THE RESTRAINT SYSTEM CAN NOT BE USED:

This child restraint is not to be used in vehicles that do not have vehicle seat belts or UAS lower anchorages.

⚠ WARNING! DEATH or SERIOUS INJURY can occur.

Seat Belt Warnings

- **ALWAYS** read your vehicle owner's manual to determine what vehicle belts and retractors are used in your vehicle belt. The vehicle belt **MUST** lock and **MUST NOT** loosen after the seat belt is tightened.

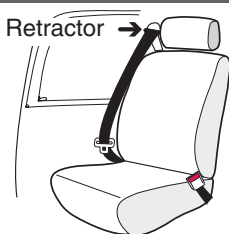

- **DO NOT** use this child restraint if it moves more than 2.5 cm (1 in.) side to side or front to back at the rear-facing belt path on the child restraint. Serious injury or death may result from poor installation. If you cannot tightly secure the child restraint, try again or move it to another location.

- **DO NOT** use this child restraint in a seating position with door-mounted seat belts.



- **DO NOT** use this child restraint in a vehicle with seat belts that automatically move along the vehicle frame when the door is opened. These seat belts will not hold a child restraint properly.

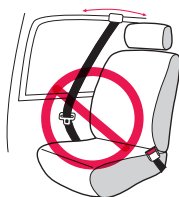

- **DO NOT** use this child restraint in a vehicle equipped with lap belts that only lock during a sudden stop or crash (emergency locking retractor – ELR). You must use a seating location with a locking seat belt. Check your vehicle owner's manual to see if you have lap belts with ELRs.



- **DO NOT** use on vehicle seats with lap only belts when both portions of the belt are positioned forward of the seat crease.



WARNING! DEATH or SERIOUS INJURY can occur.

Seat Belt Warnings

- **DO NOT** use with lap/shoulder belts with two retractors. If the vehicle seat belts are not routed and fastened correctly, the child restraint may not protect the child in a crash.
- **DO NOT** use with inflatable seat belts.
- If the vehicle seat belts are not routed and fastened correctly, the child restraint may not protect the child in a crash.
- Check your vehicle owner's manual to determine how to lock your seat belt for child restraint installation. The seat belt must be locked to properly secure the child restraint.
- **DO NOT** allow the vehicle seat belt release button to touch the child restraint. Accidental contact may cause the seat belt to release. If necessary, turn the seat belt release button away from the child restraint or move the child restraint to a different location.
- Failure to adjust the harness snugly around the child may result in the child striking the vehicle's interior during a sudden stop or crash.
- This child restraint must be securely belted to the vehicle, **even when it is unoccupied**, since in a crash an unsecured child restraint system may injure other occupants.
- Fold-down armrests could pose a hazard to a rear-facing child in certain types of collisions. Consult your vehicle owner's manual before installing any rear-facing child restraint in front of a fold-down armrest.
- The headrest on the vehicle seat that the child faces should be placed in the lowest position. The vehicle seat back that the child faces must be fully padded and free of any hard objects.



⚠ WARNING! DEATH or SERIOUS INJURY can occur.

Seat Belt Warnings

If you have any of these types of vehicle belt systems listed, these are SAFE to use to install your child restraint in the vehicle. Review vehicle owner's manual for specific instructions on child restraint installation.

LATCH/UAS can be used IN PLACE OF these vehicle belt types. Refer to your vehicle owner's manual for **LATCH/UAS** locations.

Lap Belt with Locking Latch Plate

Once buckled, the vehicle belt is tightened by pulling on the free end of the strap until the belt is tight.

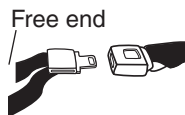

Lap Belt with Automatic Locking Retractor (ALR)

The automatic locking retractor does not allow the lap belt to get longer once it is buckled. The vehicle belt is tightened by feeding seat belt webbing into retractor.



Lap/Shoulder Belt with Locking Latch Plate

The lap portion of this belt does not loosen once the belt is buckled.

The vehicle belt is tightened by pulling up hard on shoulder belt and feeding the extra webbing into the retractor.

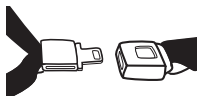

Lap/Shoulder Belt with Sliding Latch Plate with Locking Retractor

The latch plate slides freely along the lap/shoulder belt. Vehicle belts with sliding latch plates are typically locked at the shoulder belt retractor by buckling the belt and pulling all of the webbing out slowly to switch the retractor.

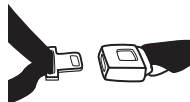

Check vehicle owner's manual for specific instructions. The vehicle belt is tightened after switching the retractor by pulling up on shoulder belt and feeding the webbing into the retractor.

⚠ WARNING! DEATH or SERIOUS INJURY can occur.



LATCH/UAS Warnings

LATCH (Lower Anchors and Tethers for **CH**ildren) and **UAS** (Universal Anchorage System) are acronyms that refer to a pair of fixed Lower Anchors (or bars) and a Top Tether anchor that are built into your vehicle, in vehicles built after September 1, 2002.

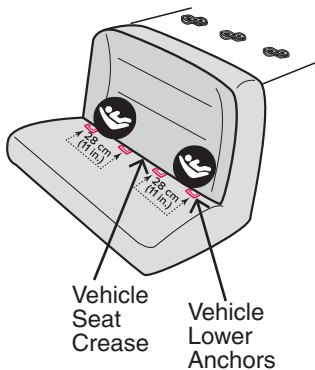

The lower **LATCH/UAS** anchors are located in the crease, or bight, between the vehicle seat back and seat cushion, and if not visible, will typically be indicated by  symbol. Top tether anchors are located in various places behind the rear vehicle seat.

Center installation in a non-standard LATCH/UAS position:

Center installation of this child restraint is permitted using inner Lower Anchor Bars from the outside seating positions if (1) your vehicle manual allows such installation; and (2) the inner Lower Anchor Bars from the outside seating positions are 28-51 cm (11-20 in.) apart.

LATCH/UAS typically offers an easier and more consistent installation. However, this child restraint can be safely installed using either **LATCH/UAS** or vehicle belts and meets the requirements of Federal Motor Vehicle Safety Standard FMVSS 213 with either installation method. Either method is safe for your child when installed correctly.

DO NOT install this child restraint with **LATCH/UAS** and the vehicle's seat belts at the same time. Your vehicle owner's manual may also refer to this system as ISOFIX or Lower Universal Anchorage System (LUAS).

The **LATCH/UAS** system is intended to be used **ONLY** as described in these instructions. Serious injury or death may result from misuse. Refer to your vehicle Owner's Manual for lower anchor bar positions in your vehicle.

WARNING! DEATH or SERIOUS INJURY can occur.

LATCH/UAS Warnings



- In addition to these instructions, read and follow your vehicle owner's manual regarding installation of the child restraint and **LATCH/UAS**. If there is a discrepancy, follow your vehicle owner's manual.
- **ONLY** use for securing convenience base to vehicle lower anchor bars.
- **NEVER** attach two lower anchor connectors to one vehicle lower anchor bar.
- **NEVER** use the vehicle seat belts when using the Lower anchor connector assembly. Using both together can cause slack in a sudden stop or crash.
- When not in use, the lower anchor connector assembly should be securely stored in the storage area located in the convenience base. Keep out of reach of children.
- **ALWAYS** be sure that the lower anchor connectors are attached to the vehicle lower anchor bars by pulling hard on the lower anchor connectors. If they are not attached, the lower anchor connector assembly will not secure your child restraint.
- **DO NOT** use this child restraint if it moves more than 2.5 cm (1 in) side to side or front to back at the belt path on the child restraint. If you cannot tightly secure the child restraint, try again or move it to another location.

Usage Warnings

- Children have **STRANGLED** in loose or partially buckled harness straps. Fully restrain the the child even when carrier is used outside the vehicle.
- In hot or sunny weather, **ALWAYS** check the areas of the child restraint that may contact your child (e.g., buckle, buckle tongues, etc.) for hot areas before placing him/her into the child restraint. The child could be burned. Cover the child restraint with a light colored blanket when you leave the vehicle.
- In cold weather, **DO NOT** dress the child in bulky clothing like snowsuits if the child is riding in a child restraint. Bulky coats/snowsuits make it difficult to properly tighten the harness to the child, which may allow the child to be ejected from the restraint during a crash. If necessary, place a blanket over the harnessed child without interfering with the child restraint harness system.

WARNING! DEATH or SERIOUS INJURY can occur.

Usage Warnings

- Failure to follow installation instructions could result in serious injury or death. These instructions, the instructions in your vehicle owner's manual, and the instructions on your child restraint must be followed carefully. If there is a conflict between the two, the vehicle owner's manual regarding child restraint installation must be followed.
- **ALWAYS** place the handle in **Position 1** or **3** when traveling in a vehicle (see "Using the Carrier Handle" on page 18).
- **NEVER** place this child restraint on beds, sofas, or other soft surfaces. The child restraint can roll over on soft surfaces and suffocate the child.
- **NEVER** place this child restraint near the edges of counter tops, tables, other high surfaces, or in shopping carts. The child's movements can cause the child restraint to slide and fall.
- The canopy is not intended to provide UV protection.



Motor Vehicle/Aircraft Usage

When used with the internal harness and properly installed pursuant to these instructions, this restraint is certified for use only in passenger and multi-purpose passenger motor vehicles, buses and trucks equipped with either lap belts only or lap/shoulder belt systems, and in aircraft if used without the base.

TIP! *Check with your airline before departure to make sure this restraint meets their requirements.*

Refer to pages 53-55 for complete instructions on installing your child restraint in aircraft.

Recall Information for U.S. Customers

- Child restraints could be recalled for safety reasons. You must register this restraint to be reached in a recall. Send your name, address, e-mail address if available, and the restraint's model number and manufacturing date to:

Evenflo Company, Inc.

1801 Commerce Dr.

Piqua, OH 45356

or call 1-800-233-5921.

or register online at:

www.evenflo.com/registercarseat

- For recall information, call the U.S. Government's Vehicle Safety Hotline at 1-888-327-4236 (TTY:1-800-424-9153), or go to **<http://www.NHTSA.gov>**

Tear off and mail this part

Consumer: Just fill in your name and address and e-mail address.

Your Name _____

Your Street Address _____

City _____ State _____ Zip Code _____

E-mail Address _____

CHILD RESTRAINT REGISTRATION CARD

Public Notice for Canadian Customers

- Child restraints could be recalled for safety reasons. You must register this restraint to be reached in a recall. Send your name, address, and the restraint's model number and manufacturing date to:

Evenflo Company, Inc.

1801 Commerce Dr.

Piqua, OH 45356

or call 1-937-773-3971.

or register online at:

www.evenflo.com/registercarseatcanada

- For public notice information, call Transport Canada at 1-800-333-0510 (1-613-993-9851 in Ottawa region) or go to **www.tc.gc.ca**

20001187 R/15

CANADIAN RESIDENTS ONLY
DOMICILIES DU CANADA SEULEMENT

**PRODUCT REGISTRATION CARD
CARTE D'ENREGISTREMENT DU PRODUIT**

1. Name / Nom _____

2. Street Address / Adresse _____

3. City / Ville _____ 4. Prov. / Province _____

5. Postal Code / Code postal _____

6. Telephone Number (with Area Code) /
Num. de téléphone (et indicatif régional) (____) _____

7. Email Address / Adresse électronique _____

8. Date of Purchase / Date d'achat _____

ATTENTION: This card may be important to the safety of your child. Please complete using blue or black ink and mail this card so that you can be contacted in the event of a safety defect notice on this product. The information you provide must be complete.
Or register online at www.evenflo.com/registercarseatcanada.

ATTENTION: Cette carte pourrait être importante à la sécurité de votre enfant. Veuillez remplir cette carte à l'encre bleue ou noire et la poster afin de pouvoir être contacté en cas d'un avis de défaut lié à la sécurité de ce produit. Les informations fournies doivent être complètes. Ou enregistrez-vous en ligne à www.evenflo.com/registercarseatcanada.

PLACE DATE/MODEL # LABEL HERE.
AFFIXER L'ÉTIQUETTE DE LA DATE ET
DU NUMÉRO DE MODÈLE ICI.

Child Restraint Features

Front View

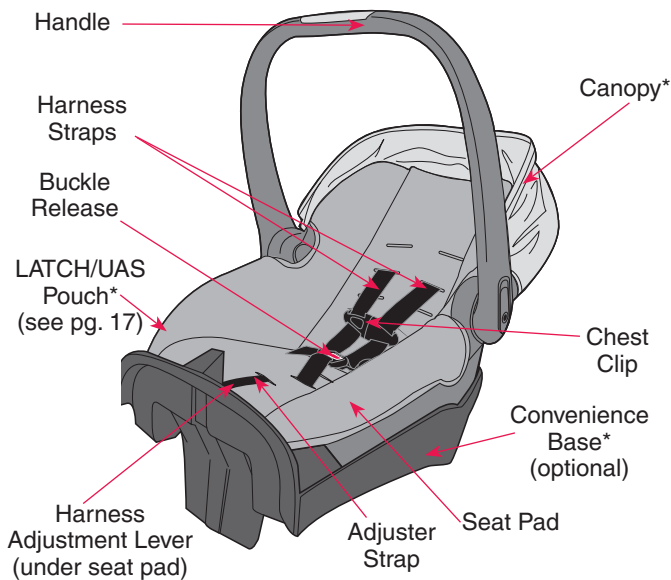

Back View

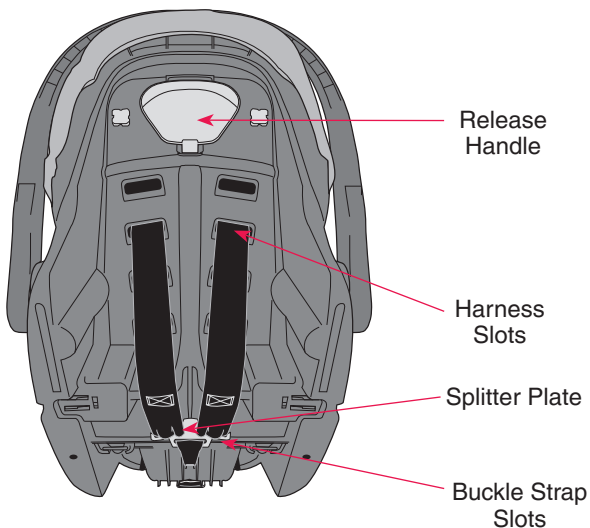

**Not all features are available on all models. Styles may vary.*

Child Restraint Features

NurtureMax Convenience Base* (Bottom)

Lower Anchor Connector Assembly

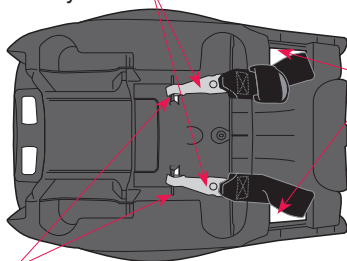

Vehicle Seat Belt Path / Lower Anchor Connector Strap Openings

Lower Anchor Connector Storage

LATCH/UAS (First Choice Only)*

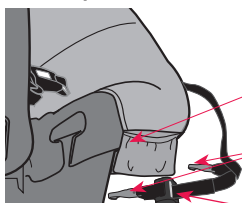

LATCH/UAS Pouch*
(only on models sold without convenience base)

LATCH/UAS Hooks

LATCH/UAS Adjuster

**Not all features are available on all models. Styles may vary.*



Removing and Storing Lower Anchor Connectors

- 1 Press the adjuster release button to loosen lower anchor connector assembly.



- 2 Press the tab and twist, then remove the hook from the anchor.

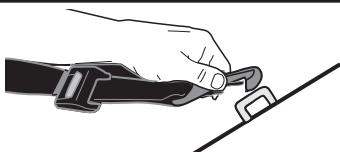

- 3 When the lower anchor connector system is not in use, you **MUST** securely store it on the storage bars on the underside of the base or in the storage pouch (First Choice version). A loose lower anchor connector strap and hook may injure your child.

Using the Carrier Handle

To change carrier handle positions, push down and rotate the handle to the desired position until it locks into place.

IMPORTANT:

- **ONLY** use **Positions 1** or **3** when traveling in a vehicle.
- **NEVER** use **Positions 2** or **3** to carry your child.

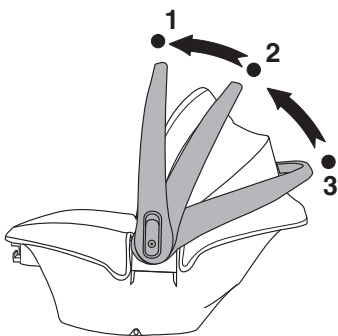

IMPORTANT: ALWAYS secure the child in the carrier. Refer to “Securing the Child in the Carrier” on page 36.

Position 1 (Carry/Travel)

ONLY use this position to carry your child or while traveling in a vehicle.

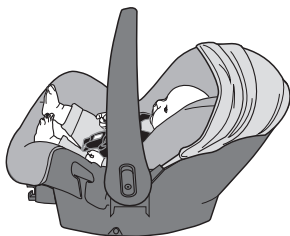

Position 2 (Safety)

NEVER use this position to carry your child or while traveling in a vehicle.

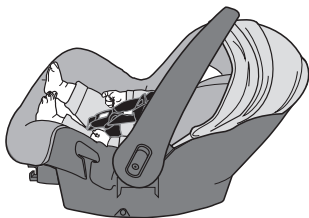

Position 3 (Travel/Convenience)

ONLY use this position when traveling in a vehicle or removing your child from the carrier (page 38).

NEVER use this position to carry your child.

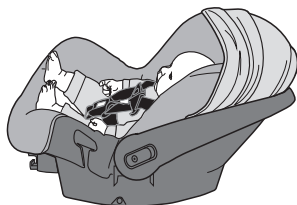

Proper Installation WITH the Base

Child Requirements

- **Weight:** 1.8 to 10 kg (4 to 22 lbs)
- **Height:** 43 to 73 cm (17 – 29 in.) and top of child's head is at least 2.5 cm (1 in.) below the top of the child restraint seat back.

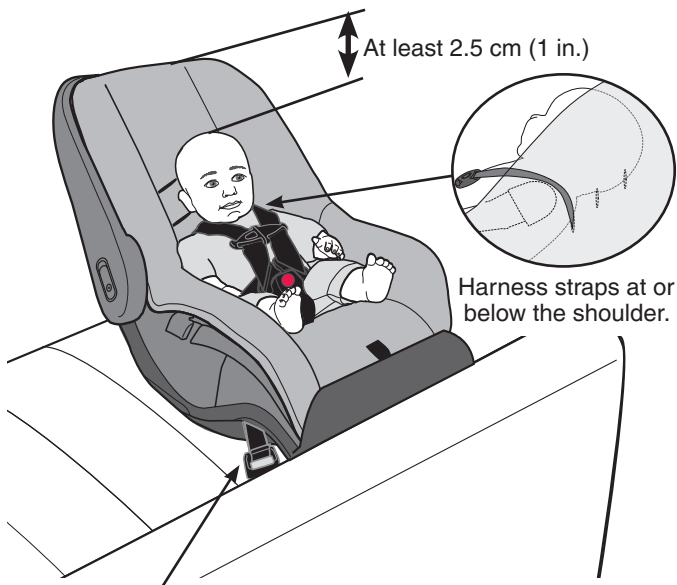

Vehicle Seat Belt / Lower Anchor Connector Assembly

IMPORTANT: Once your child **exceeds** any of the size requirements above, you **MUST** discontinue use of this child restraint.



Installing the Base with Lower Anchor Connectors

⚠ WARNING! DEATH or SERIOUS INJURY can occur.

- This lower anchor connector assembly system is intended to be used **ONLY** as described in these instructions.
- In addition to these instructions and the instructions on your child restraint, read and follow your vehicle owner's manual regarding installation of the child restraint and **LATCH/UAS**. If there is a discrepancy, follow your vehicle owner's manual.
- **ONLY** use for securing convenience base to vehicle lower anchor bars.
- **NEVER** attach two lower anchor connector hooks to one vehicle lower anchor bar.
- **NEVER** use the vehicle seat belts when using the lower anchor connector. Using both together can cause slack in a sudden stop or crash.
- When not in use, the lower anchor connectors should be securely stored in the storage area located in the convenience base (see page 17). Keep out of reach of children.
- **ALWAYS** be sure that the lower anchor connectors are attached to the vehicle lower anchor bars by pulling hard on the lower anchor connectors. If they are not attached, the lower anchor connector assembly will not secure your child restraint. Serious injury or death may result.
- To avoid strangulation, you **MUST** store the unused **LATCH/UAS** straps. Roll or fold the excess **LATCH/UAS** strap and secure with a rubber band to prevent serious injury to vehicle occupants.
- This child restraint **MUST** face the rear of the vehicle.
- **NEVER** use this child restraint in the forward-facing position.

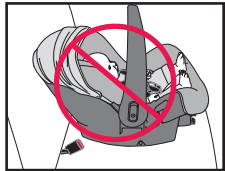

Installing the Base with Lower Anchor Connectors



- 1** Before you begin, be sure the level line is parallel to the floor of the vehicle.

Place the base on the vehicle seat and unhook the lower connectors. Route the lower anchor connector strap and hook through the lower anchor connector strap openings.

Refer to your owner's manual to locate the lower anchor bars on your vehicle seat.

Attach the right hook to the right anchor bar and the left hook to the left anchor bar. **DOUBLE CHECK** that the hooks are fully engaged by pulling hard on the lower anchor connector strap.

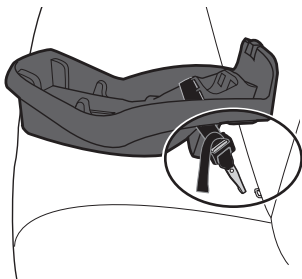

- 2** Adjust the base so that the level line is level with the ground.

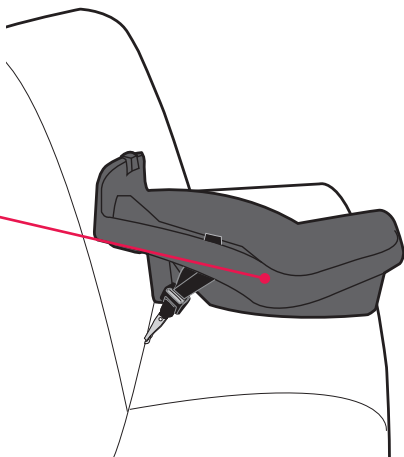
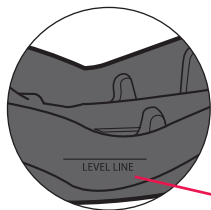



Installing the Base with Lower Anchor Connectors

3 Using your full weight, push the base firmly into the vehicle seat, while pulling up on the strap to tighten.

The lower anchor connector assembly strap must be as tight as possible.

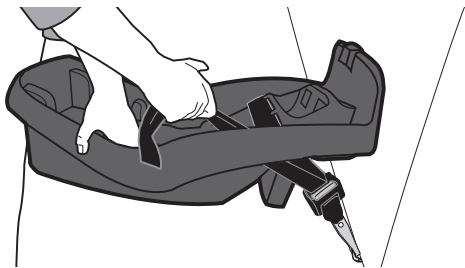

⚠ WARNING! DEATH or SERIOUS INJURY can occur.

DO NOT use this child restraint if it moves more than 2.5 cm (1 in.) side-to-side or front to back at the belt path. Move the child restraint to another seating location, try to tighten the lower anchor assembly again, or install with vehicle belts as shown on the following pages.

Continue with “Placing the Carrier in the Base” on page 25.

Installing the Base with the Vehicle Seat Belt



⚠ WARNING! DEATH or SERIOUS INJURY can occur.

- The carrier **MUST** be locked firmly into the convenience base. Check by lifting up on the carrier.
- **NEVER** use the vehicle seat belts when using the lower anchor connector. Using both together can cause slack in a sudden stop or crash.
- This child restraint **MUST** face the rear of the vehicle.
- **NEVER** use this child restraint in the forward-facing position.
- Check your vehicle owner's manual to determine how to lock your seat belt for child restraint installation. The seat belt **MUST** be locked to properly secure the child restraint.

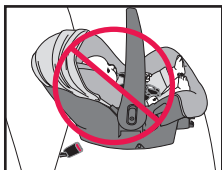

1 Before you begin, be sure the level line is parallel to the floor of the vehicle.

Secure the convenience base to your vehicle seat by routing the vehicle seat belt through the openings as shown, then buckle the vehicle belt.

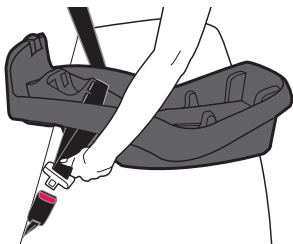

2 Adjust the base so that the level line is level with the ground.

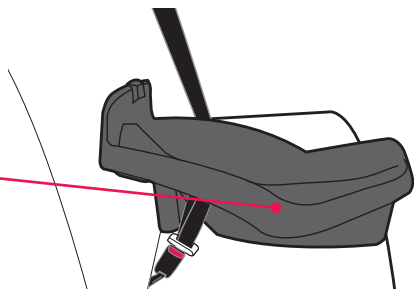
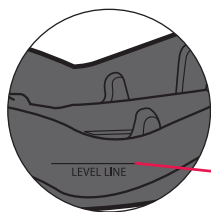



Installing the Base with the Vehicle Seat Belt

- 3** If level line is not level with the ground, uninstall the base and place a tightly rolled towel or small blanket beneath the front edge of the base in order to provide enough recline for an infant's head to lie back comfortably. Then buckle the vehicle belt and continue with step 4.

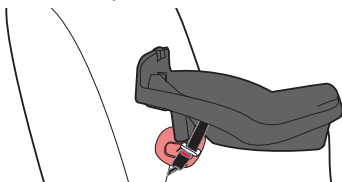

IMPORTANT: Infants may have difficulty breathing when in a sitting position. Make sure they recline enough for their head to lie back comfortably and safely. Failure to properly recline the child restraint could increase the child's risk of serious injury or death.

4

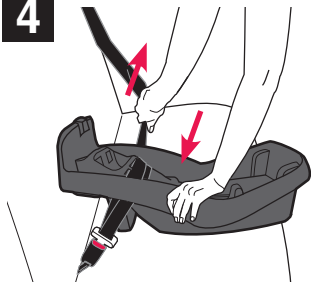

Lock the vehicle seatbelt. Pull the shoulder belt tightly to remove all slack from the lap portion of the vehicle seat belt and, at the same time, push down on the base using your full weight. Check to be sure the base is secured in the vehicle seat.

LAP BELT

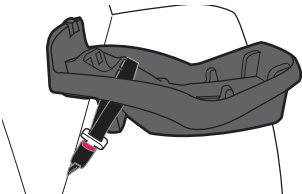

LAP/SHOULDER BELT

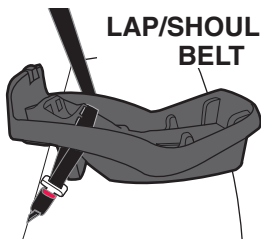

IMPORTANT: Some vehicle belts cannot be switched into locking mode for child restraint installation. It may be necessary to use a locking clip in these situations. To install a locking clip, refer to page 46. Refer to the vehicle owner's manual to determine which type of belt retractor is in the vehicle.

⚠ WARNING! DEATH or SERIOUS INJURY can occur.

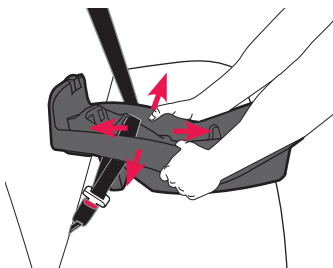

DO NOT use this child restraint if it moves more than 2.5 cm (1 in.) forward or side-to-side at the seat belt path. Move the child restraint to another seating location, try to tighten the seat belt again, or use the lower anchors instead.

Continue with “Placing the Carrier in the Base” on page 25.

Placing the Carrier in the Base

- 1** Tilt front of infant car seat down so that front edge goes below hook on base (see image) and allows seat to rotate down. Plungers will disappear into the base and reappear in windows when locked.

NOTE: Ensure Adjuster strap is inside the child restraint before placing front edge of seat under base hook.

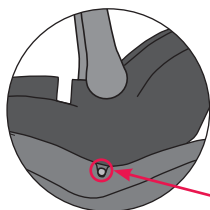

Hook

IMPORTANT: Plungers must be visible through windows to ensure that seat is securely installed.

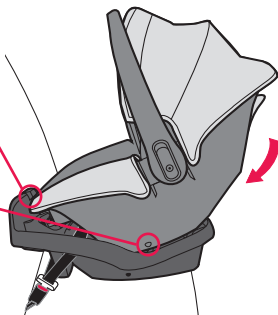

⚠ WARNING! DEATH or SERIOUS INJURY can occur.

The carrier **MUST** be locked firmly into the base. Check by lifting up on the back (head end) of the seat to make sure it is locked in place.

Placing the Carrier in the Base

- 2** With the infant car seat installed, check that the base is still level with the ground.

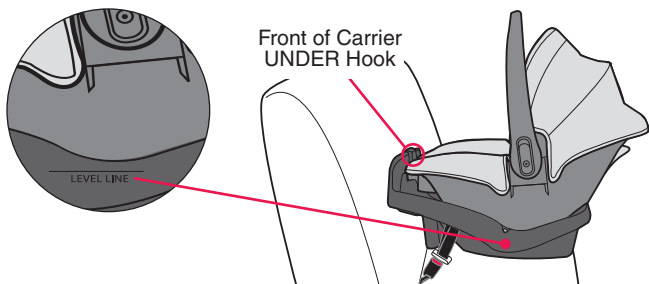

- 3** Push down and rotate the handle to the desired position until it locks into place. **ALWAYS** place the handle in **Position 1** or **3** while traveling in a vehicle (page 18).

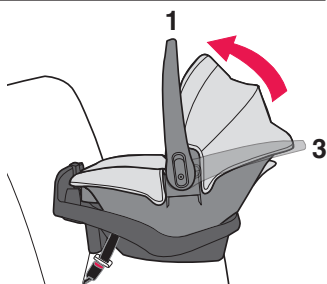

Releasing the Carrier from the Base

- 1** With the handle in **Position 1**, squeeze the base release lever on the back of the child restraint, rotate rear of seat up and out of base, then lift the carrier out.

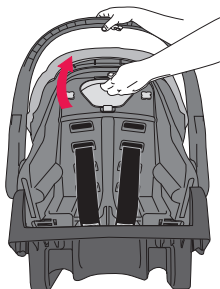

Checklist: Installation with Base

⚠ WARNING! DEATH or SERIOUS INJURY can occur.

Child's head **MUST** be at least 2.5 cm (1 in.) below the top of the carrier.

1. Secure the convenience base to the vehicle seat.

- ✓ Convenience base is securely installed with lower anchor connector assembly system (page 20)
OR
- ✓ Convenience base is securely installed with vehicle seat belt (page 23).

IMPORTANT: A properly secured convenience base does **NOT** move more than 2.5 cm (1 in.) from side-to-side or from front-to-back **at the lower anchor connector assembly/vehicle belt path.**

- ✓ Locking clip is installed, if necessary (page 46).
- ✓ The level line on the base is level with the ground (pages 21, 23, and 26).
- ✓ If necessary, a towel/small blanket is rolled up and placed beneath the front edge of the base so the level line is level with the ground (page 24).

2. Secure the child in the carrier (pages 36-37).

- ✓ Harness straps **MUST** start as close as possible to, but **NEVER** above, the child's shoulders (page 36).
- ✓ Both buckle tongues are fastened (page 36).
- ✓ Chest clip is securely fastened and at armpit level (page 37).
- ✓ Harness straps are snug against the child and you should not be able to pinch the harness (page 37).
- ✓ Buckle strap is snug against the child but **NOT** under the child's bottom (page 36).

3. Check your work.

- ✓ Convenience base is adjusted so that level line is level with ground (pages 21 and 23).
- ✓ The convenience base does **NOT** move more than 2.5 cm (1 in.) from side-to-side or from front-to-back **at the lower anchor connector assembly/vehicle belt path** (pages 22 and 25).
- ✓ The handle is in **Position 1** or **Position 3** (page 26).

Proper Installation WITHOUT the Base

Child Requirements

- **Weight:** 1.8 to 10 kg (4 to 22 lbs)
- **Height:** 43 to 73 cm (17 to 29 in.) and top of child's head is at least 2.5 cm (1 in.) below the top of the child restraint seat back.

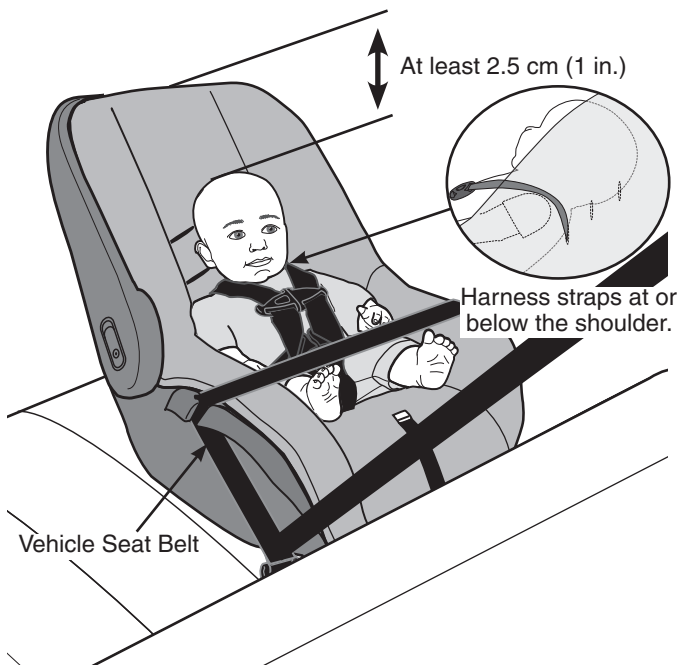

IMPORTANT: Once your child **exceeds** any of the size requirements above, you **MUST** discontinue use of this child restraint.

Installing the Carrier without the Base Using Vehicle Seat Belts



! WARNING! DEATH or SERIOUS INJURY can occur.

- This child restraint **MUST** face the rear of the vehicle.
- **NEVER** use this child restraint in the forward-facing position.
- Check your vehicle owner's manual to determine how to lock your seat belt for child restraint installation. The seat belt must be locked to properly secure the child restraint.

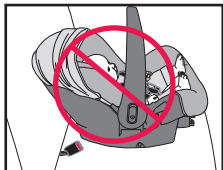

- 1** After securing the infant, place the restraint rear-facing into your vehicle as shown and adjust the restraint so that the level line is level with the ground.

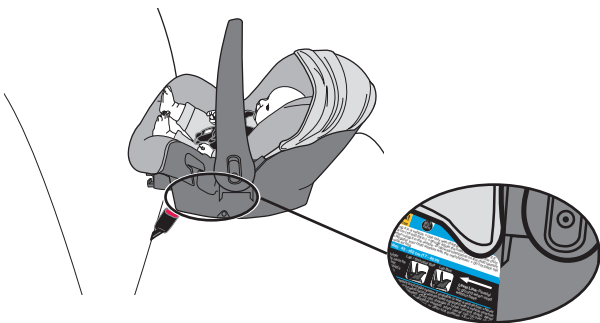



Installing the Carrier without the Base Using Vehicle Seat Belts

2

LAP BELT ONLY

Route the vehicle seat belt through the belt guides on the carrier.

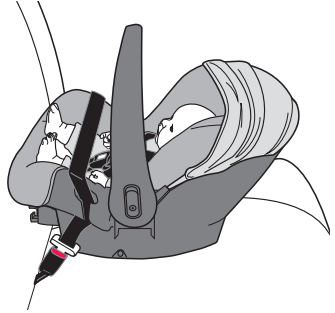

LAP/SHOULDER BELT

In vehicles with a lap and shoulder belt, route the **LAP PORTION ONLY** through the belt guides. Route the **SHOULDER PORTION** diagonally across the vehicle seat back as shown. Lock the vehicle seat belt.

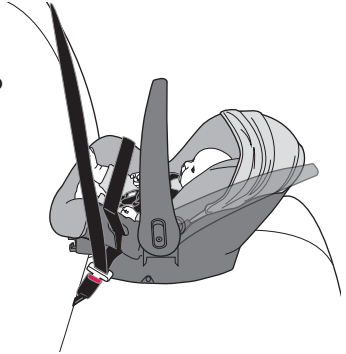

IMPORTANT: Some vehicle belts cannot be switched into locking mode for child restraint installation. It may be necessary to use a locking clip in these situations. To install a locking clip, refer to page 46. Refer to the vehicle owner's manual to determine which type of belt retractor is in the vehicle.

Installing the Carrier without the Base Using Vehicle Seat Belts



- 3** The seat belt must be as tight as possible. Push down on the bottom of the seat using your full weight as you tighten the vehicle belt.

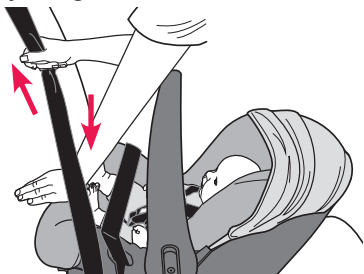

! WARNING! DEATH or SERIOUS INJURY can occur.

DO NOT use this child restraint if it moves more than 2.5 cm (1 in.) side-to-side or front to back at the vehicle belt path. Move the child restraint to another seating location, try to tighten the seat belt again, or install using the base.

- 4** If the level line is not level to the ground, use a tightly rolled towel or small blanket beneath the front edge of the child restraint. Loosen the vehicle belt. Place a rolled towel under the seat and repeat the installation process.

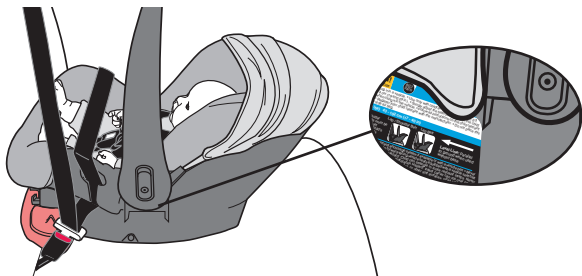

IMPORTANT: Infants may have difficulty breathing when in a sitting position. Make sure they recline enough for their head to lie back comfortably and safely. Failure to properly recline the child restraint could increase the child's risk of serious injury or death.



Installing the Carrier without the Base Using Vehicle Seat Belts

- 5 Push down and rotate the handle to **Position 1** or **3** when traveling in a vehicle (page 18).

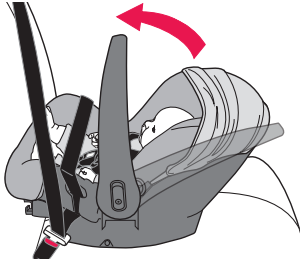

Installing the Carrier without the Base Using Lower Anchor Connectors*

- 1 After securing the infant, place the restraint into your vehicle. Adjust the restraint so that the level line is level with the ground.

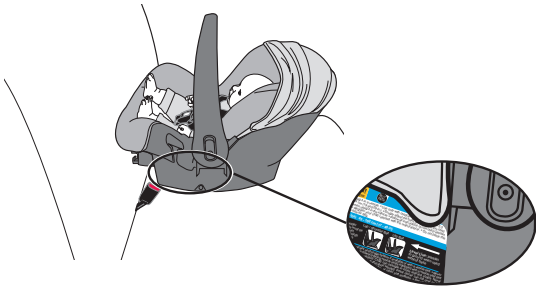

IMPORTANT: This infant restraint **MUST** face the rear of the vehicle (p. 29).

- 2 Remove lower anchor connectors from storage pouch.

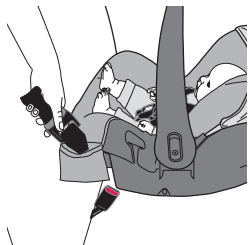

**Not all features are available on all models. Styles may vary.*

Installing the Carrier without the Base Using Lower Anchor Connectors*



- 3** Feed lower anchor connectors through belt guides, making sure the connector straps do not become twisted.

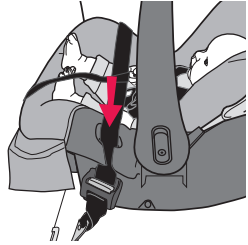

- 4** Refer to your vehicle owner's manual to locate the lower anchor bars on your vehicle seat, then attach the right hook to the right anchor bar and the left hook to the left anchor bar. **DOUBLE CHECK** that the lower anchor connector hook is fully engaged by pulling hard on the lower anchor connector strap.

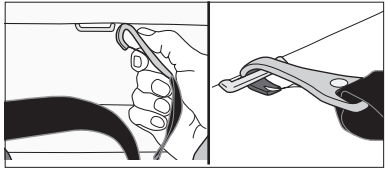

- 5** Using your full weight, push the carrier into the vehicle seat, while pulling up on the strap to remove all slack from the lower anchor connector assembly.

IMPORTANT: Make sure both lower anchor connectors are connected as shown and the straps are not twisted.

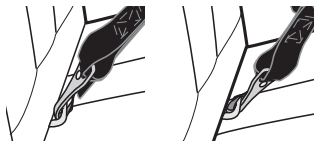
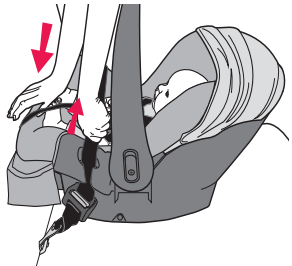

Correct

Incorrect

*Not all features are available on all models. Styles may vary.



Installing the Carrier without the Base Using Lower Anchor Connectors*

- 6** Make sure the lower anchor connector assembly is tight. Grab the Infant Carrier at the belt path as shown. If you can move the carrier more than 25 mm (1 in.) side-to-side or front to back, the installation is not tight enough. You will need to try again or find another location for your Infant Carrier.

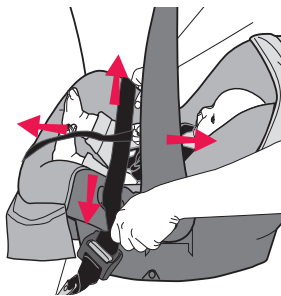

To remove lower anchor connectors, disconnect from vehicle anchors and store in pouch (p. 32).

- 7** If the level line is not level to the ground, use a tightly rolled towel or small blanket beneath the front edge of the child restraint. Loosen the lower connectors. Place a towel under the seat and repeat the installation process.

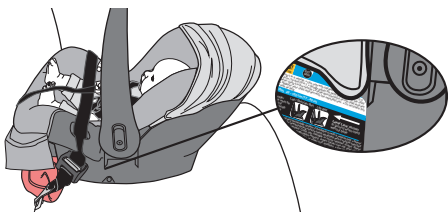

IMPORTANT: Infants may have difficulty breathing when in a sitting position. Make sure they recline enough for their head to lie back comfortably and safely. Failure to properly recline the child restraint could increase the child's risk of serious injury or death.

- 8** Push down and rotate the handle to **Position 1** or **3** when traveling in a vehicle (page 18).

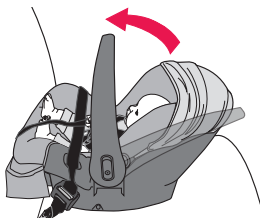

*Not all features are available on all models. Styles may vary.

Checklist: Installation without Base

WARNING! DEATH or SERIOUS INJURY can occur.

Child's head **MUST** be at least 2.5 cm (1 in.) below the top of the carrier.

1. Place the child in the carrier.

- ✓ The child's back and bottom are flat against the back and bottom surfaces of the carrier.

2. Secure the child in the carrier (pages 36-37).

- ✓ Harness straps **MUST** start as close as possible to, but **NEVER** above, the child's shoulders (page 36).
- ✓ Both buckle tongues are fastened (page 36).
- ✓ Chest clip is securely fastened and at armpit level (page 37).
- ✓ Harness straps are snug against the child and you should not be able to pinch the harness (page 37).
- ✓ Buckle strap is snug against the child but **NOT** under the child's bottom (page 36).

3. Secure child restraint to the vehicle seat.

- ✓ Carrier is securely installed with vehicle seat belt (page 30) or with lower anchor connectors (page 32).
- ✓ The shoulder strap portion of the seat belt is lying across the vehicle seat back (page 30).
- ✓ Locking clip is installed, if necessary (page 46).
- ✓ The level line is level with the ground (page 31).
- ✓ If necessary, a towel/small blanket is rolled up and placed beneath the front edge of the carrier so the child's head lies back comfortably (page 31).

4. Check your work.

- ✓ The carrier **MUST NOT** move more than 2.5 cm (1 in.) from side-to-side or from front-to-back at the vehicle belt path.
- ✓ The handle is in **Position 1** or **Position 3** (page 32).

General Information

Securing the Child in the Carrier



Place the baby in the carrier. Baby's bottom and back should be flat against the seat. If there is a gap, baby will not be comfortable.

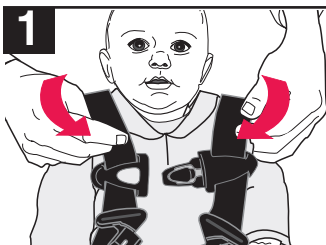

Slide each harness strap over the child's shoulders.

Harness straps **MUST** start as close as possible to, but **NEVER** above, the child's shoulders.

- 2** Facing the front of the buckle, place the left buckle tongue on top of the right buckle tongue. Then insert both tongues in the nested position, into the buckle opening until you hear an audible click. Pull up on the harness strap to ensure the buckle tongues are engaged.

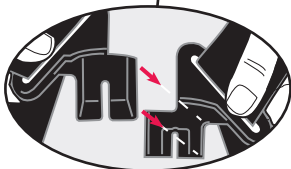
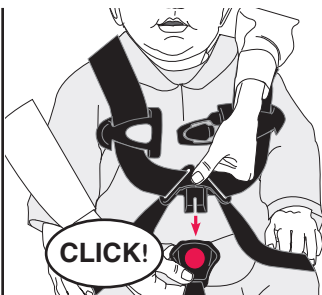
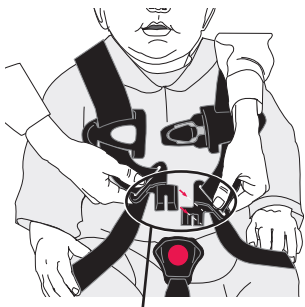

IMPORTANT: The buckle strap should be snug against the baby but never under the baby's bottom. Adjust the buckle strap if necessary (page 41).

Securing the Child in the Carrier

- 3** Align the two sides of the chest clip at the child's armpit level and snap them together.

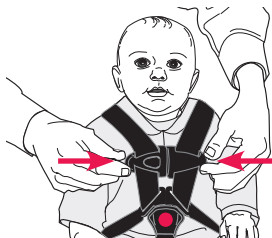

- 4** Tighten the harness straps by pulling on the adjuster strap at the child's feet. The harness straps must be snug against the child. A snug strap should not allow any slack. It lies in a relatively straight line without sagging. It does not press on the child's flesh or push the child's body into an unnatural position.

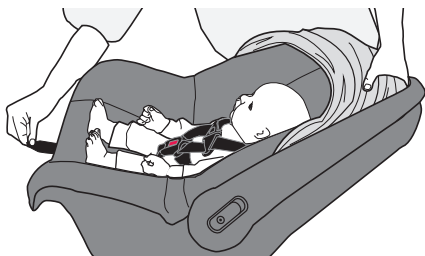

Check the harness straps near the shoulders for slack. You should **NOT** be able to pinch the harness (see below). Adjust as needed.

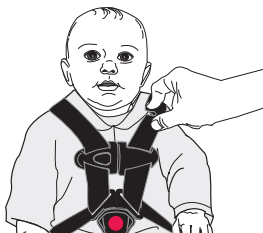

Removing the Child from the Carrier

1



Press the red buckle release and remove the buckle tongues.

2



Push the release button and pull the chest clip apart.

3

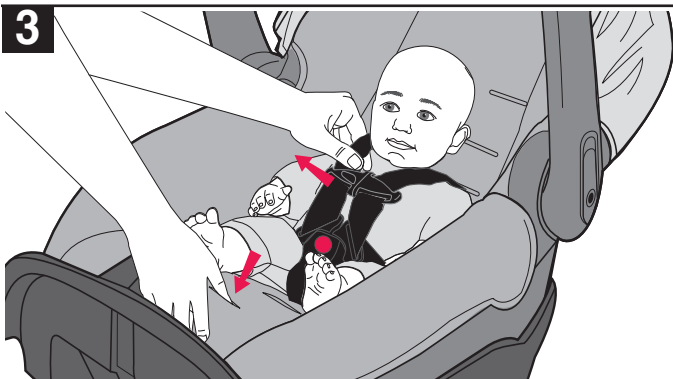

To loosen the harness, push down on the harness adjustment lever and pull harness straps.

Changing the Harness Position

As your child grows, you will need to change the harness strap position so that the harness straps are routed through the slots closest to the child's shoulders. The shoulder harness straps should always be as close as possible to, but never above, the child's shoulders.

- 1** Loosen the harness straps by pressing the harness adjustment lever while pulling on the straps.

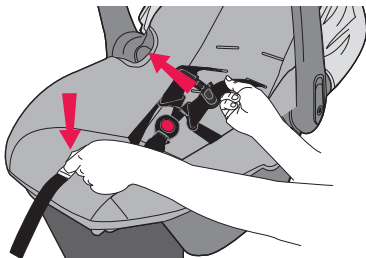

- 2** Slide one harness strap off of the splitter plate.

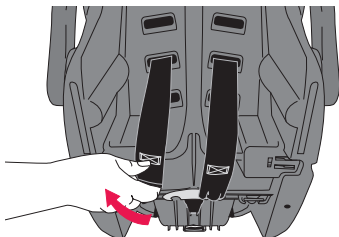

- 3** Pull harness strap through the front of the child restraint.

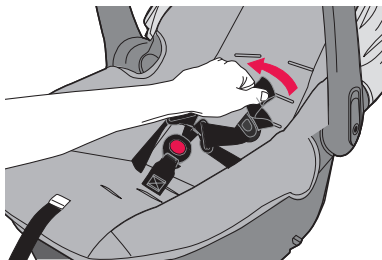

Changing the Harness Position

- 4** Insert harness strap into new harness position slot.

IMPORTANT: When inserting harness straps through the slots in the seat pad, make sure you route them correctly through their corresponding slots in the seat shell.

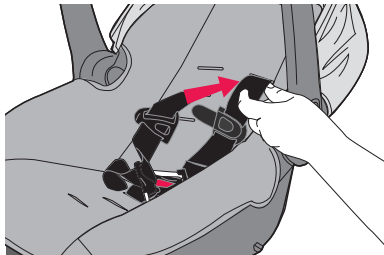

- 5** Make sure the harness strap is installed completely on the splitter plate as shown, then repeat steps 2-5 for other side.

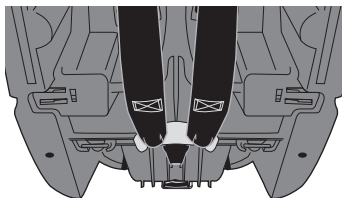

- 6** Tighten the harness straps by pulling the adjustment strap on front of the restraint.

NOTE: Final adjustment of the harness straps must be completed with the baby in the child restraint.

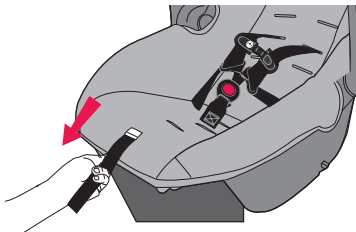

Changing the Buckle Strap Position

As your child grows, you will need to change the buckle strap position so that it is in the slot closest to your child. The buckle strap should always be as close as possible to, but not under, the child's bottom.

There are four positions in which to use the buckle strap, based upon your child's comfort.

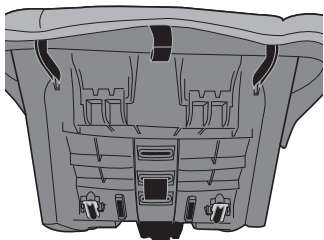

Buckle Strap in Newborn Mode (see page 43)

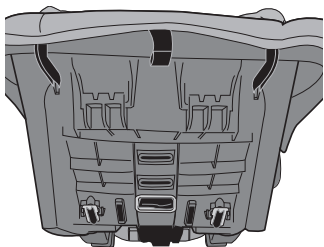

Buckle Strap in the Rear Slot

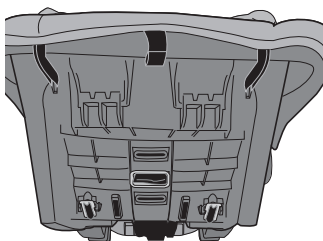

Buckle Strap in the Middle Slot

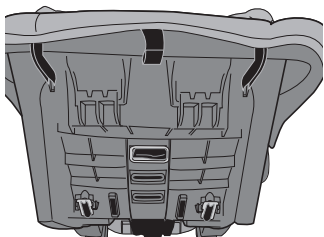

Buckle Strap in the Front Slot

Changing the Buckle Strap Position

- 1** Loosen the harness straps (p. 38) and move the strap out of the way.

Remove the Buckle Strap anchor from its position on the bottom of the carrier, and push the anchor up through the slot to the top of the seat.

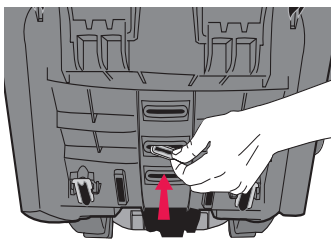
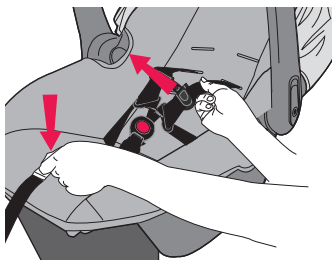

- 2** Insert the Buckle Strap anchor into the slot that is the closest to the child, but not under the child's bottom.

Make sure the anchor is completely through and is lying flat against the bottom of the seat. Pull up on the Buckle Strap to make sure it is securely fastened.

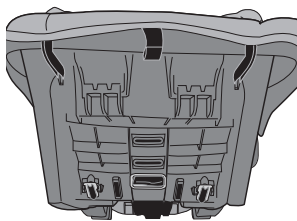
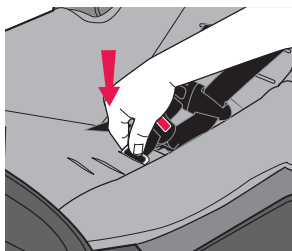

Changing the Buckle Strap Position

- 3** For **Newborn Mode**, place the anchor through the rear slot then feed it through the middle slot.

Make sure the anchor is completely through the middle slot and is lying flat against the bottom of the seat.

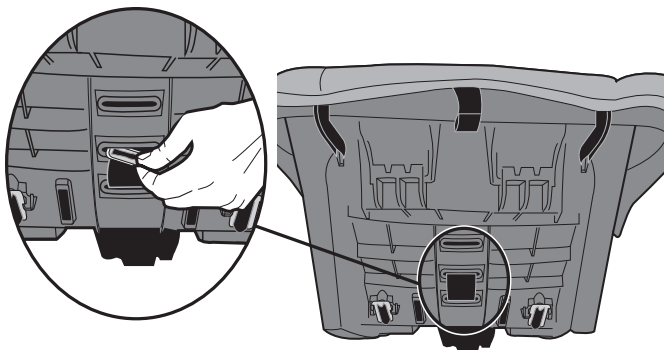

Changing the Waist Strap Position

As your child grows, you will need to change the waist strap position so that it is in the slot closest to your child. The waist strap should always be as close as possible to, but not under, the child's legs, as suggested in the chart below.

Approximate Child Size		Suggested Waist Strap Positioning
Small	1.8 - 2.7 kg (4 - 6 lbs)	Inner Slot
Medium/ Large	2.7 - 10 kg (6 - 22 lbs)	Outer Slot

NOTE: NurtureMax ships with both waist anchors in the outer slots.

- 1** To reposition waist straps from outer to inner slots, loosen the harness straps by pressing the harness release button while pulling on the harness straps.

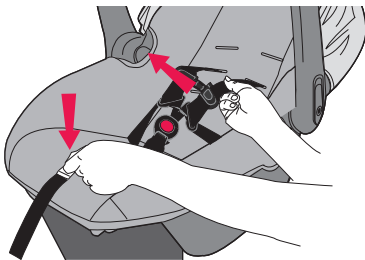

- 2** Push the Buckle Strap through the slot in the seat pad.

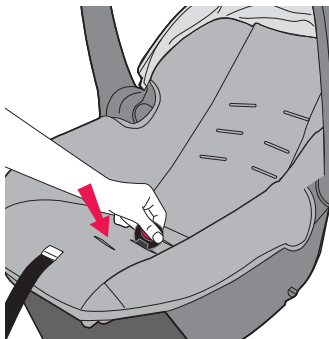

Changing the Waist Strap Position

- 3** Unhook the front of the child restraint's seat pad and move it out of the way to expose the waist strap slots and anchors.

Remove the waist strap anchor from the outer slot on bottom of the seat, and push the anchor up through the slot to the top of the seat. Repeat for other side.

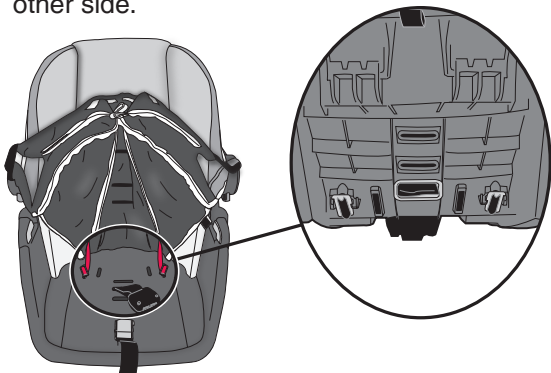

- 4** Push the anchor down through the appropriate inner slot to the bottom of the seat then feed it through the outer slot to the top of the seat and repeat for other side.

NOTE: See chart on page 44 to find the appropriate waist strap slots for your child's size.

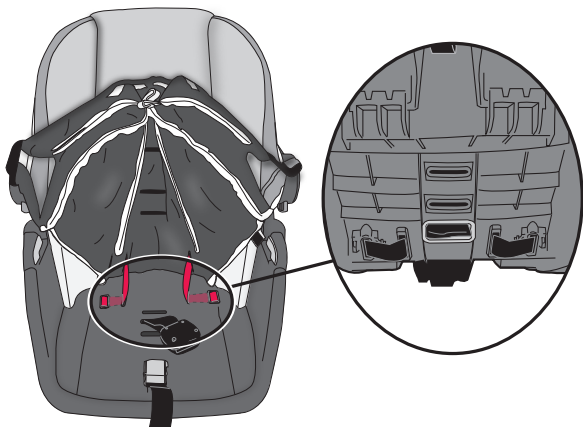

Using a Locking Clip

If your vehicle was built **prior to model year 1996**, and has a lap/shoulder belt that is equipped with an emergency locking retractor (ELR) **AND** sliding latch plate, you **MUST** use a Locking Clip. Check your vehicle owner's manual to identify which vehicle belt system is in your vehicle and contact ParentLink to obtain a Locking Clip. If your vehicle is **model year 1996 or newer**, it likely has a vehicle belt system that can be locked when tightened, and will not require use of a Locking Clip. **Consult your vehicle owner's manual before installing a Locking Clip.**

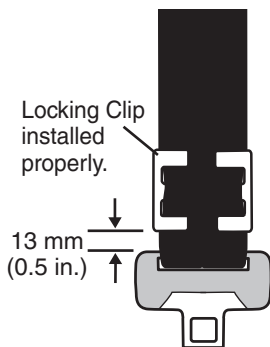

1

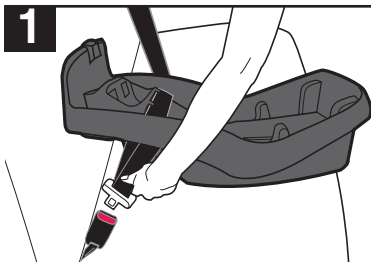

Thread the seat belt through the base (or child restraint) and buckle the seat belt.

2

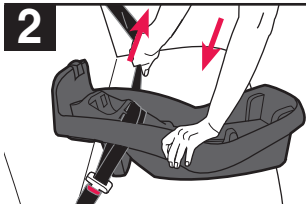

Push down on the base while pulling the shoulder belt tightly to remove all slack from the lap portion of the belt.

3

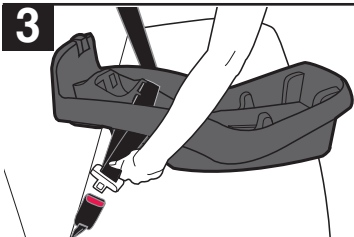

Hold the lap and shoulder belts together just behind the free sliding buckle tongue and unbuckle the seat belt.

Using a Locking Clip

4

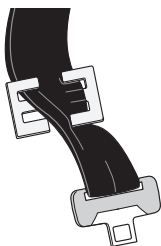

While holding the belts and buckle tongue, thread the locking clip onto the seat belt, and slide it into place.

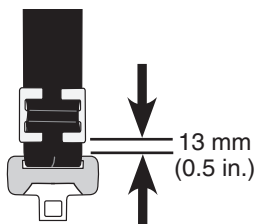

Note: Locking clip must be placed within 13 mm (0.5 in.) of seat belt buckle.

5

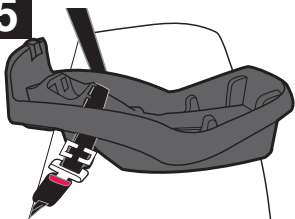

Buckle the seat belt with the locking clip in place.

- If using a vehicle seat belt and installing the **convenience base only**, return to page 23, Step 1.
- If using a vehicle seat belt and installing the **carrier with no base**, return to page 31, Step 3.

! WARNING! DEATH or SERIOUS INJURY can occur.

Remove locking clip from vehicle seat belt when not used with a child restraint, or the vehicle seat belt will not properly restrain an adult or child.

Using as an Infant Carrier

⚠ WARNING! DEATH or SERIOUS INJURY can occur.

- Child Restraints should be used only for travel. Potential adverse health effects from excessive use of infant child restraints have been documented. You should limit the time spent each day in a child restraint as much as possible. You must **NEVER** use your child restraint as a sleeping environment in the home. **NEVER** leave your infant unattended in a child restraint in or out of the vehicle. **NEVER** place this child restraint near the edges of counter tops, tables, or other high surfaces. The child's movements can cause the carrier to slide or fall.
- **NEVER** place this child restraint on beds, sofas, or other soft surfaces. The child restraint can roll over on soft surfaces and suffocate the child.
- **NEVER** leave the child in this carrier when the harness straps are loose or undone. Children have **STRANGLED** in loose or partially buckled harness straps. Fully restrain the child even when the carrier is used outside the vehicle.

- Fall Hazard: The carrier can fall from the shopping cart. Do not use on shopping cart.



Secure the child in the carrier by following "Securing the Child in the Carrier" on page 36.

To use as a carrier:

Push down and rotate the handle to **Position 1** (Carry/Travel) until it locks into place.

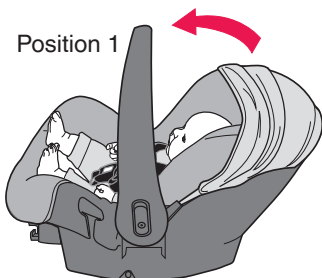

Using as an Infant Carrier

! WARNING! DEATH or SERIOUS INJURY can occur.

DO NOT carry on your hip.



CARRY AT YOUR SIDE,
using the handle as shown.

IMPORTANT: Make sure that the handle is firmly locked on both sides and that the harness is securely buckled before lifting the infant carrier.

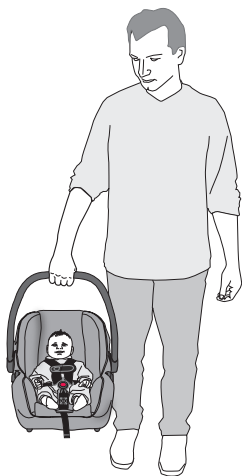

Installing the Canopy

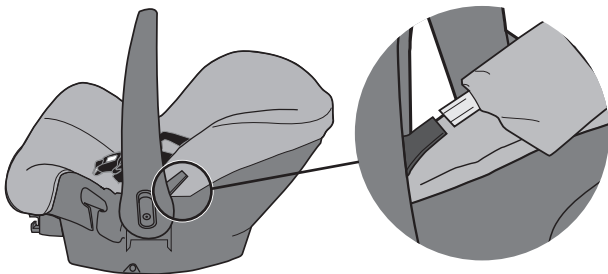

Guide each end of the canopy strip into the canopy holder located on each side of the child restraint.

Removing the Seat Cover

1

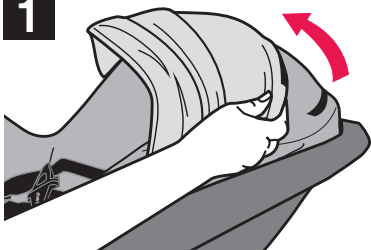

Disconnect Canopy from seat pad using hook and loop connector at rear of infant car seat.

2

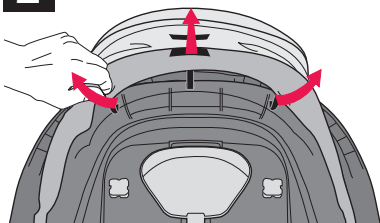

At rear of seat, unhook three hook connectors from seat shell.

3

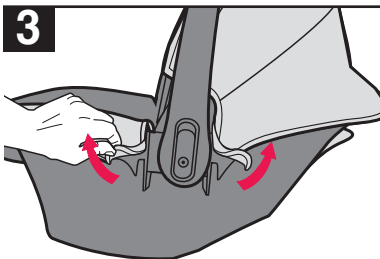

Pull the two fabric slots from tabs near the handle. Repeat on other side of infant car seat.

4

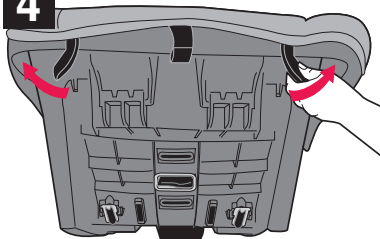

At the front of the seat, unhook the two elastic loops from the tabs.

Removing the Seat Cover

5

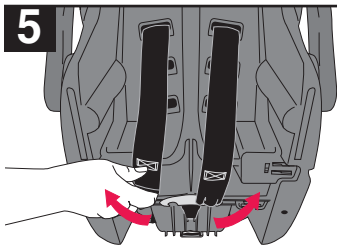

At bottom of seat, unhook harness straps from the splitter plate.

6

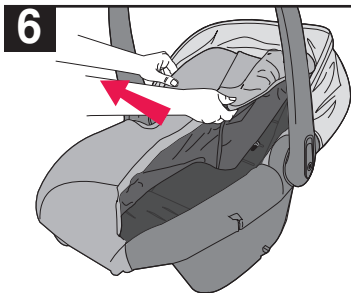

Pull harness strap, adjuster strap and buckle through fabric slots and remove seat cover as shown.

Replacing the Seat Cover

1

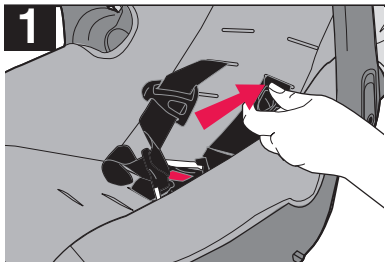

Pull harness strap, adjuster strap and buckle through fabric slots of seat cover.

2

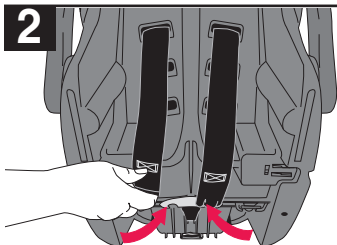

At bottom of seat, reconnect the harness straps to the splitter plate.

Replacing the Seat Cover

3

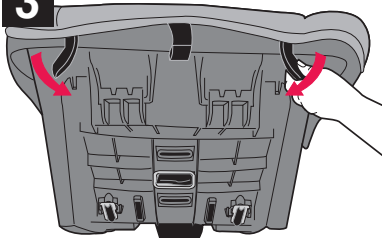

Reconnect the two elastic loops to the tabs at the front of the seat.

4

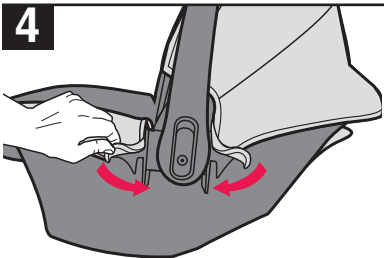

Pull the two fabric slots onto the tabs near the handle. Repeat on other side of infant car seat.

5

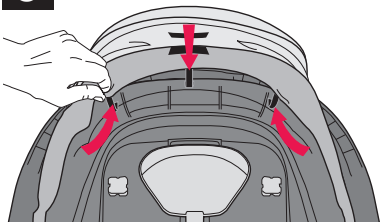

Reconnect the three hook connectors to the seat shell at rear of seat.

6

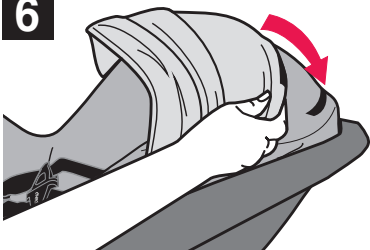

Reattach hook and loop connectors from Canopy to seat pad at rear of infant car seat.

Securing Your Child Restraint in Aircraft



The Federal Aviation Administration (FAA) recommends that you secure your child for air travel in an appropriate child restraint based on your child's weight and size. Turbulence can happen with little or no warning. When turbulence occurs, **the safest place for your child is in a properly installed child restraint, not in an adult's lap or on the aircraft seat with its seat belt.** Keeping your child in a child restraint during the flight will help ensure your family arrives safely at your destination.

The FAA recommends that a child weighing:

- more than 18 kg (40 lbs) use an aircraft seat belt;
- less than 9 kg (20 lbs) use a rear-facing child restraint; and
- from 9 to 18 kg (20 to 40 lbs) use a forward-facing child restraint.

NOTE: These FAA recommendations may vary from those applicable to the use of your child restraint in a motor vehicle.

Installing Child Restraint in Aircraft

IMPORTANT:

- You must use the internal harness when installing the child restraint in aircraft.
- Before installing the child restraint, **make sure the aircraft seat is in a fully upright position.**
- **DO NOT** use the convenience base when installing child restraint in aircraft.

1

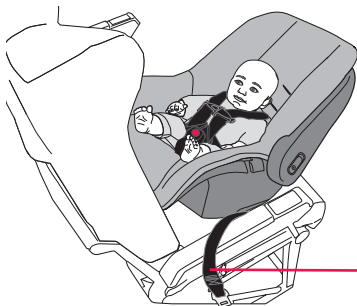

Aircraft
Seat Belt

Place the child restraint on the aircraft seat **rear-facing**, as shown above. Make certain that the level line on the seat is level with the floor of the aircraft.

Installing Child Restraint in Aircraft

- 2** Route the aircraft seat belt through the belt slots on the carrier, as shown below.

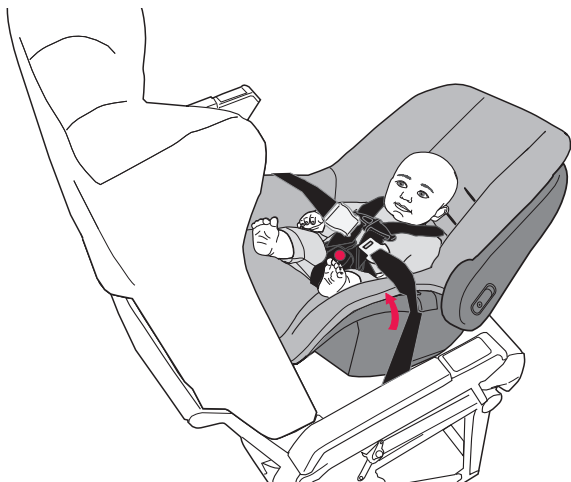

3



Fasten the aircraft seat belt.

Installing Child Restraint in Aircraft

4

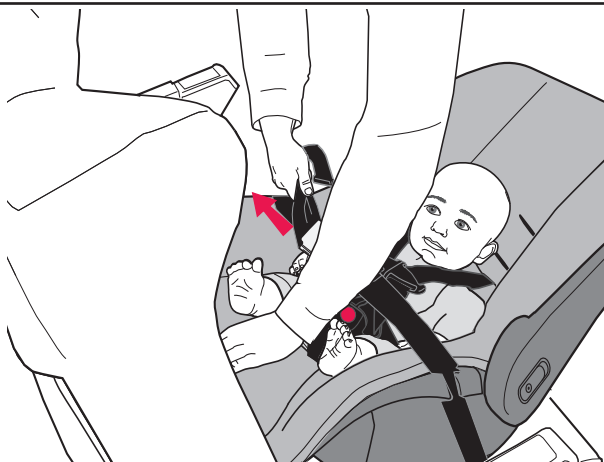

The aircraft seat belt must be as tight as possible. Using your full weight, push the child restraint firmly onto the aircraft seat while pulling on the excess seat belt strap to tighten. Route the excess seat belt strap back through the belt slots, as shown above.

Check your work. Try to move the child restraint in all directions. If you can move the child restraint more than 2.5 cm (1 in.) side-to-side or front to back at the belt path, the aircraft seat belt is not tight enough, and you **MUST** install again until the seat belt is tight.

5

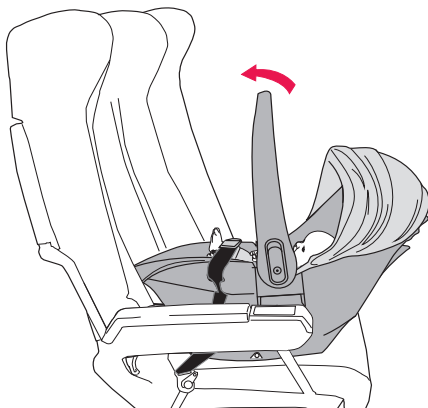

Push down and rotate the handle to **Position 1** (Carry/Travel) until it locks into place.

Care and Cleaning

- **DO NOT** lubricate or immerse in water the **LATCH/UAS** connectors, the buckle, or any other part of this child restraint, unless rinsing is permitted, as stated on the back of the buckle for your restraint.
- Plastic and metal parts may be wiped clean with mild soap and water and dried with a soft cloth. Do not use abrasive cleaners or solvents.
- Take care not to damage any labels.
- The harness can be wiped clean with mild soap and water. Allow harness to air dry.
- Machine wash the seat pad separately in cold water, delicate cycle. Tumble dry 10 to 15 minutes on low heat.
- To protect the child restraint from damage caused by weather, rodents, and other elements common to garages, the outdoors, and other storage locations, remove the seat pad and thoroughly clean the restraint and pad prior to storage. Take care to clean in the areas where crumbs and other debris tend to accumulate.

TIP! To help protect the vehicle upholstery, place a towel beneath and behind the child restraint.

Replacement Parts

To order replacement parts, you can order online at www.evenflo.com or contact Evenflo. When you contact us, please have the product model number and date of manufacture (found on the back of the child restraint).

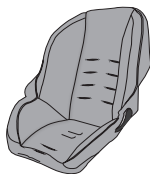

Seat Pad

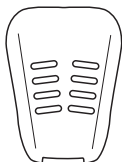

Head Foam

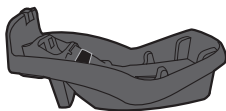

Convenience Base

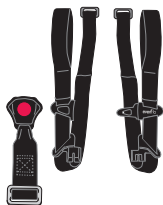

Harness System



Canopy



Lower Anchor
Connector
Assembly

IMPORTANT

If you decide to obtain an additional base for your NurtureMax child restraint, look for *sku/part number* “6401000.”

This *sku/part number* will appear on a label on the back of the base and will be printed on the front of the carton.



#6401000

sku/part number

Proper Disposal of this Child Restraint

When this child restraint reaches the expiration date found on the date of manufacture label, Evenflo encourages you to dispose of it properly. Most components of this child restraint are recyclable.

1. Remove all fabric and padding.
2. Remove all screws and disassemble the restraint.
3. Recycle all fabric, padding, plastic, foam and metal parts, if accepted by your local recycling center. Responsibly discard the rest.

If your local recycling center won't accept the padding, you may dispose of it in the landfill.

IMPORTANT: To prevent injury due to hidden damage, lost instructions, outdated technology, etc. discontinue use of this restraint after the expiration date on the label or if it has been involved in a crash.

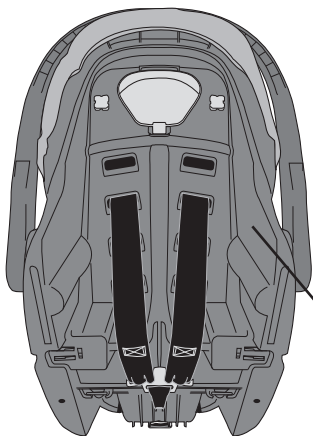

Manufactured in / Fabriqué en

year/année | month/mois | day/jour

Name / Nom

Model / Modèle

Made in / Fabriqué in

Expires on / Expire le

60000056

Storing Your Instructions

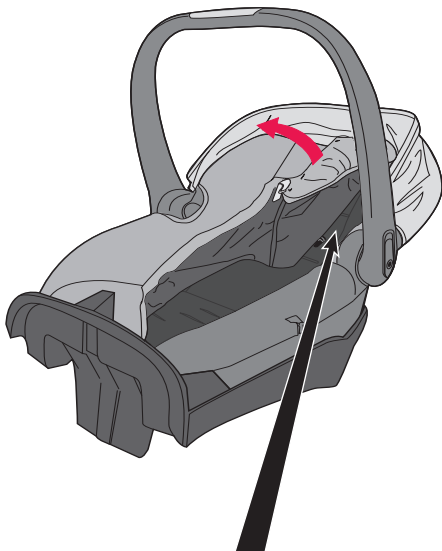

After thoroughly reading and following these instructions, store them in the carrier behind the seat pad, as shown.

For future reference, record the **model number** of your child restraint AND the **date of manufacture** below.

Model Number: _____

Date of Manufacture: _____

Limited Warranty

For a period of 90 days from the original purchase of this Product, Evenflo warrants to the original end user ("Purchaser") this Product (including any accessories) against defects in material or workmanship. Evenflo's sole obligation under this express limited warranty shall be, at Evenflo's option, to repair or replace any Product that is determined to be defective by Evenflo and determined to be covered by this warranty.

Repair or replacement as provided under this warranty is the exclusive remedy of the Purchaser. Proof of purchase in the form of a receipted invoice or bill of sale evidencing that the Product is within the warranty period must be presented to obtain warranty service. This express limited warranty is extended by Evenflo ONLY to the original Purchaser of the Product and is not assignable or transferable to subsequent purchasers or end users of the Product. For warranty service, contact Evenflo's ParentLink Consumer Resource Center

EXCEPT TO THE EXTENT PROHIBITED BY APPLICABLE LAW, ANY IMPLIED WARRANTY OF MERCHANTABILITY OR FITNESS FOR A PARTICULAR PURPOSE ON THIS PRODUCT IS HEREBY DISCLAIMED. EVENFLO SHALL NOT BE LIABLE FOR ANY INCIDENTAL, CONSEQUENTIAL, SPECIAL OR PUNITIVE DAMAGES OF ANY KIND FOR BREACH OF THE EXPRESS LIMITED WARRANTY ON THIS PRODUCT, OR ANY WARRANTY IMPLIED BY OPERATION OF LAW. OTHER THAN THE EXPRESS LIMITED WARRANTY SET FORTH ABOVE, THERE ARE NO OTHER WARRANTIES THAT ACCOMPANY THIS PRODUCT AND ANY ORAL, WRITTEN OR ANY OTHER EXPRESS REPRESENTATION OF ANY KIND IS HEREBY DISCLAIMED.

ParentLink®

answers. advice. affirmation.™

www.evenflo.com

USA: 1-800-233-5921 8 AM – 5 PM E.T.

Canada: 1-937-773-3971

Mexico: 800-706-1200