



Extended Warranty
Sign Up

E-1

Welcome home!

VN-L00010

VN-L00010BN

VN-L00010AB

VN-L00011

VN-L00012

VN-L00013

TEAMSON HOME
Arquer Arc Floor Lamp

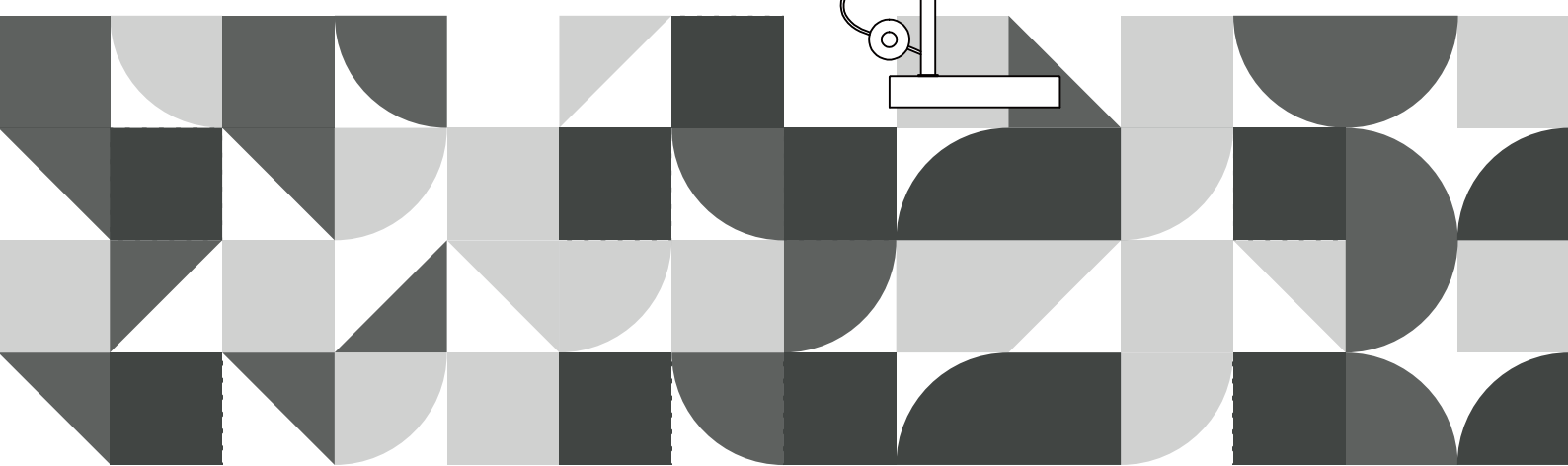
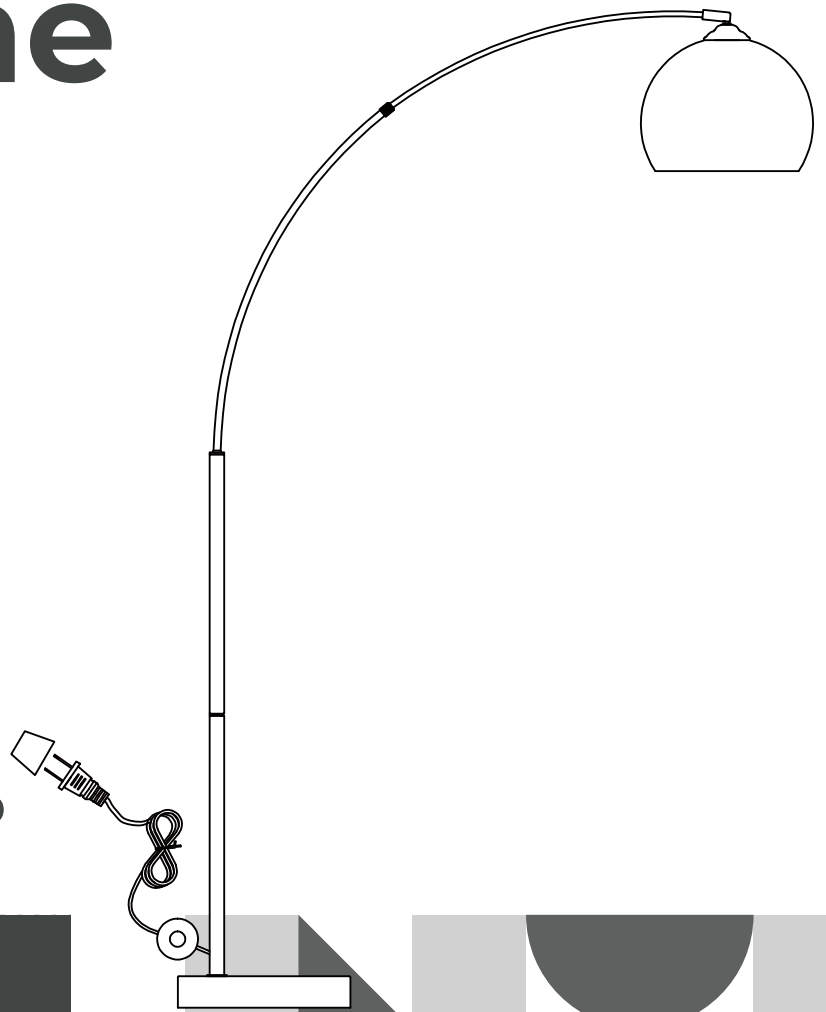



**Questions? Comments? Need help?
Call or email us any time!**

Global Customer Service

USA

+1(800)935-3959

Mon - Fri 10:00am ~ 2:00pm EST
✉ support@teamson.com

EU/UK

+44(0)1952-916-050

Mon - Thu 9:00am ~ 5:00pm GMT
Friday 9:00am ~ 4:00pm GMT
✉ support@teamson.co.uk

If the external flexible cable or cord of this luminaire is damaged, it shall be exclusively replaced by teamson.uk or a similar qualified person in order to avoid a hazard.

ASIA

深圳办公室:

+86(0755)8885-3558.分机号331

Mon - Sat 9:00am ~ 5:00pm GMT+8
✉ sales_ec@teamson.com

台北办公室:

+886(2)2556-6268

Mon - Fri 9:00am ~ 5:00pm GMT+8
✉ sales_ec@teamson.com

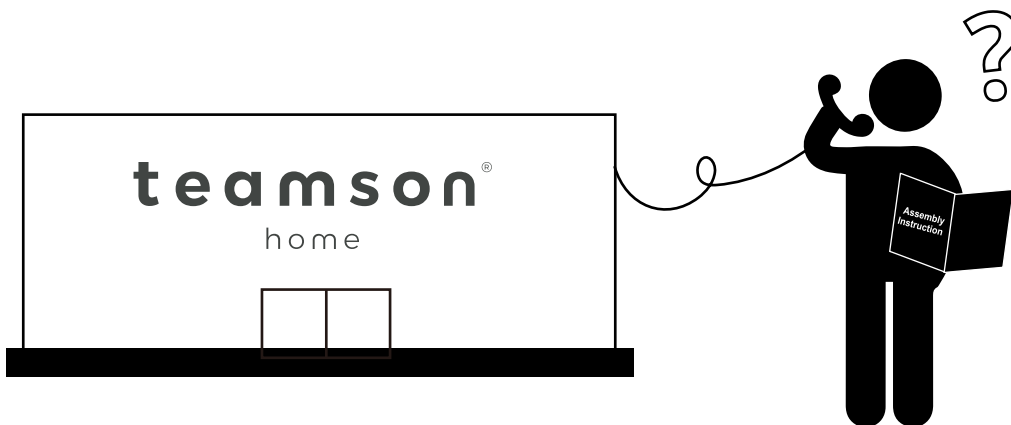
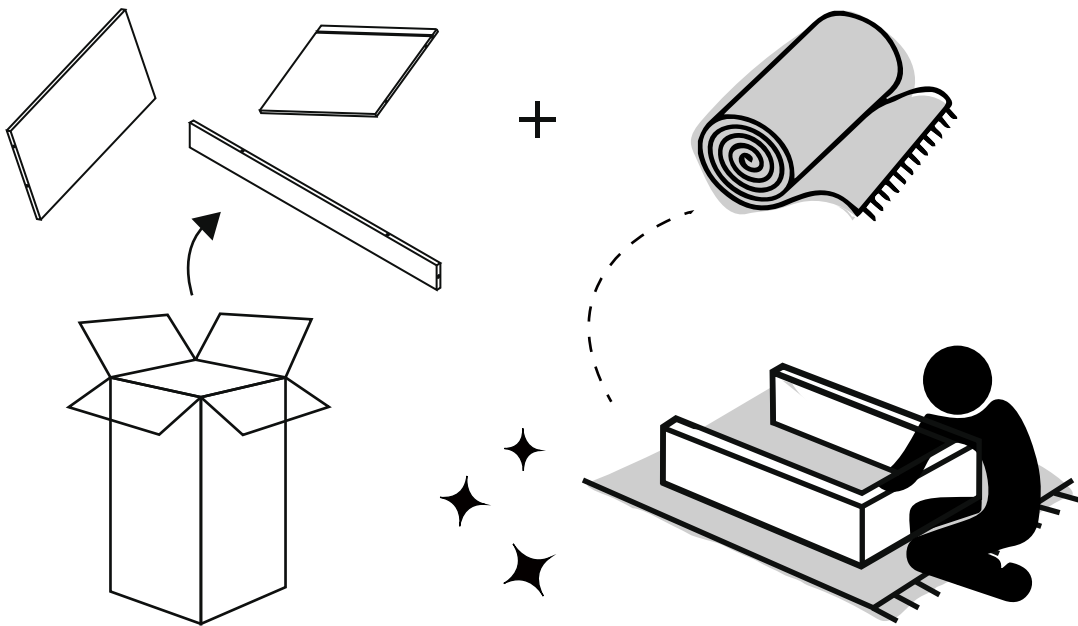
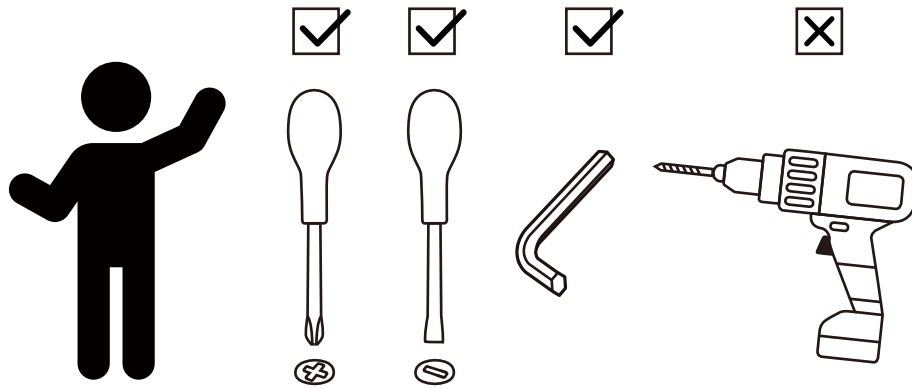

** Got questions? Please have your product code (on the first page of this instruction, e.g. TD-12345A) and the order number ready, give us a call or email us through our customer care support! We are always ready to assist you!

Warranty

LIMITATIONS

All components are warranted by the manufacturer for a period of 30 days after the date of purchase by the original owner against defects in materials and workmanship under normal use. If it is appropriate to replace your product, the manufacturer will replace the product with the same product or a comparable product at the manufacturer's option.

GENERAL TERMS AND CONDITIONS

1. Proof of purchase is necessary to request a claim under this warranty.
2. This warranty does not apply to appearance or accessory items.
3. This warranty does not include damage due to improper packing, handling, or transportation. For products lost or damaged in transit, a claim operation at pressures in excess of recommended maximums.
4. This warranty does not cover any costs associated with the installation and removal of products or parts subject to this warranty. This warranty shall not apply to acts of God, nor shall it apply to products which, have been subject to negligence, abuse, accident, misapplication, tampering, alteration or modification; nor due to improper installation, operation, maintenance, repair or storage; nor to other than normal application, use or service, including but not limited to, operational failures caused by corrosion, rust or other foreign materials in the system, or operation at pressures in excess of recommended maximums.

INSTRUCTIONS

For specific instructions about how to obtain warranty service for your Product, please contact Customer Service using the contact information on the above side of this page. In general, you will need to deliver your Product in either its original packaging or in equally protective packaging to the address specified by Customer Service. Before you deliver your Product for warranty service, it is your responsibility to remove any removable personal stuff or other materials you may have stored or preserved in your Product. It is possible that such personal stuff or other materials will be destroyed, lost, or reformatted during service, and we will not be responsible for any such damage or loss.

Some jurisdictions do not allow limitations on how long a statutory or implied warranty lasts, so the above limitation may not apply to you. We are not responsible for direct, special, incidental, or consequential damages resulting from any breach of warranty or under any other legal theory. In some jurisdictions the foregoing limitation does not apply to death or personal injury claims, or any statutory liability for intentional and gross negligent acts and/or omissions, so the above exclusion or limitation may not apply to you. Some jurisdictions do not allow the exclusion or limitation direct, incidental, or consequential damages, so the above exclusion or limitation may not apply to you. This "LIMITATIONS" section does not apply to customers in the European Union.

This limited warranty gives you specific rights. You may have additional rights under applicable law, and this limited warranty does not affect such rights.

Exploded Drawing

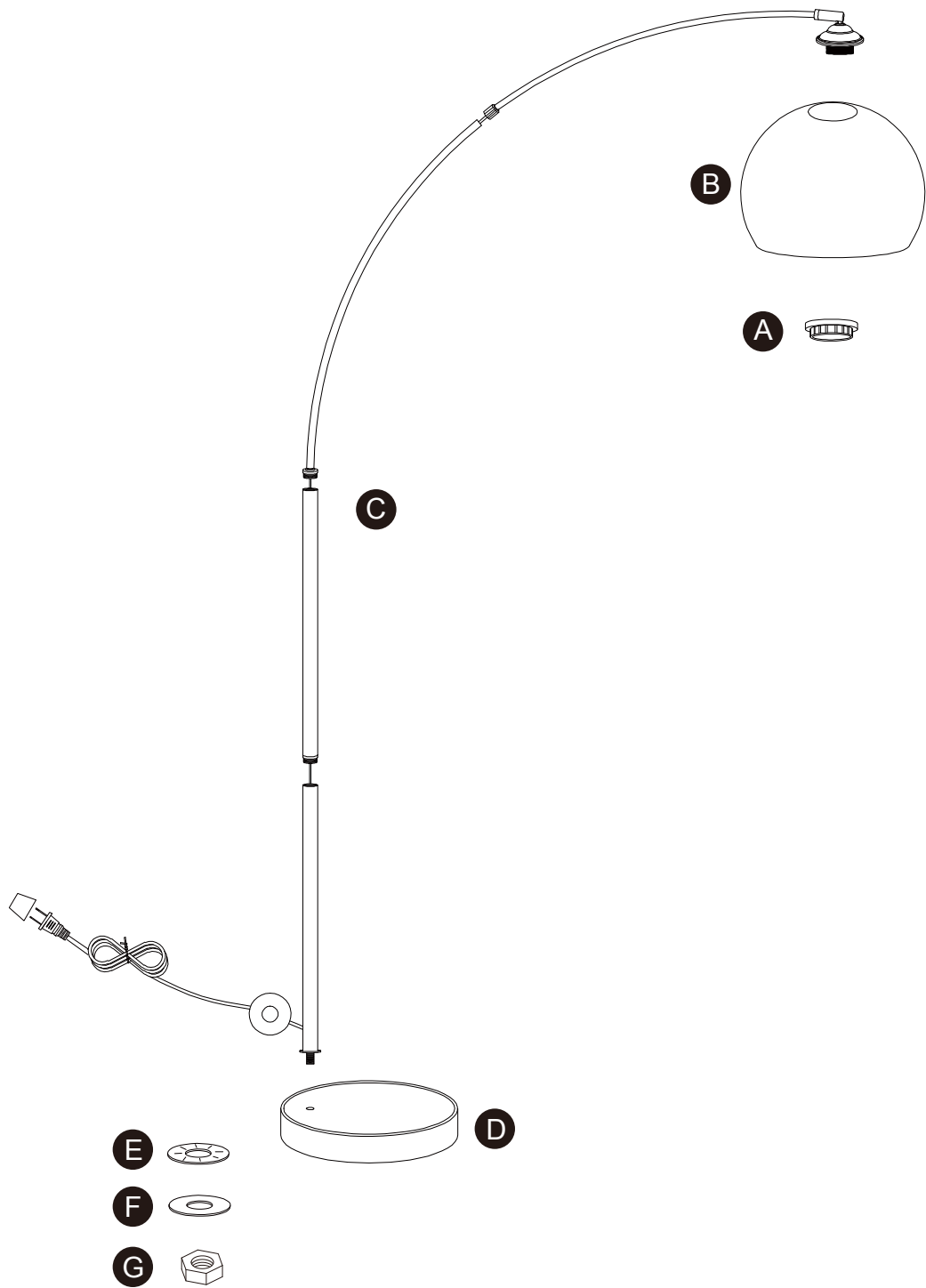

Scan for assembly instructions.

Product Parts

A

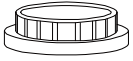

1 PC

B

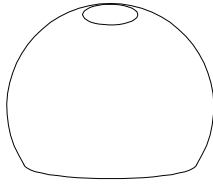

1 PC

C

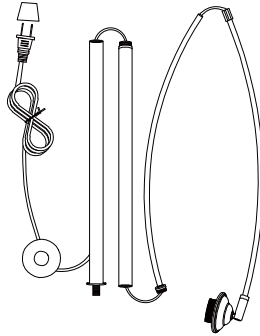

1 PC

D



1 PC

E



1 PC

F



1 PC

G



1 PC

Hardware

1

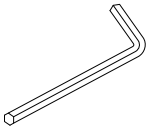

1 PC

2

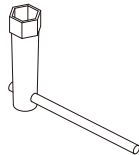

1 PC

! Care Instructions

Dust surface with a dry soft cloth. Do not use window cleaners or cleaning abrasives as they will scratch the surface and could damage the protective coating

! WARNING

Small parts and sharp edges may be present prior to assembly.



Scan for assembly instructions.

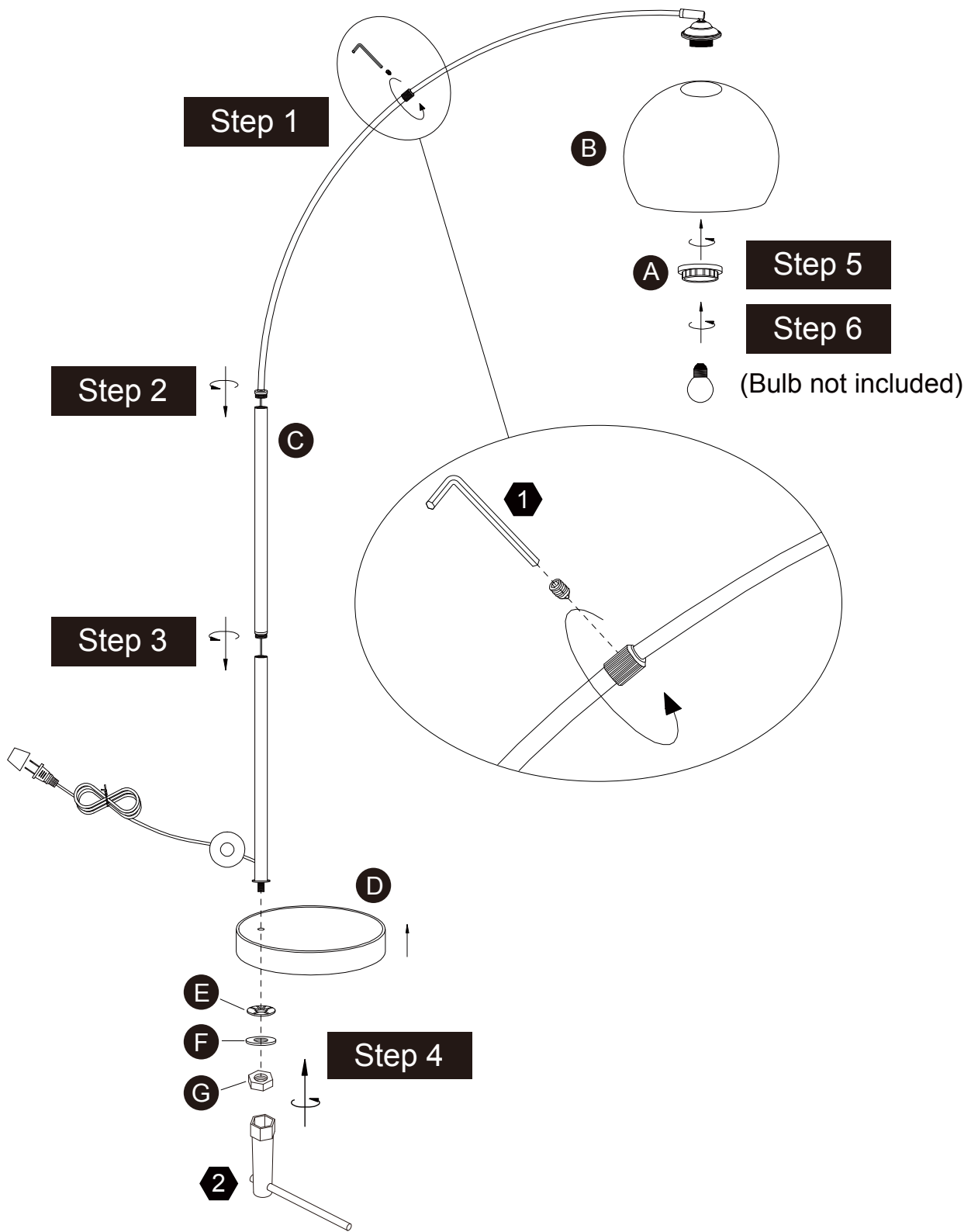

Scan for assembly instructions.