

INSTRUCTION MANUAL

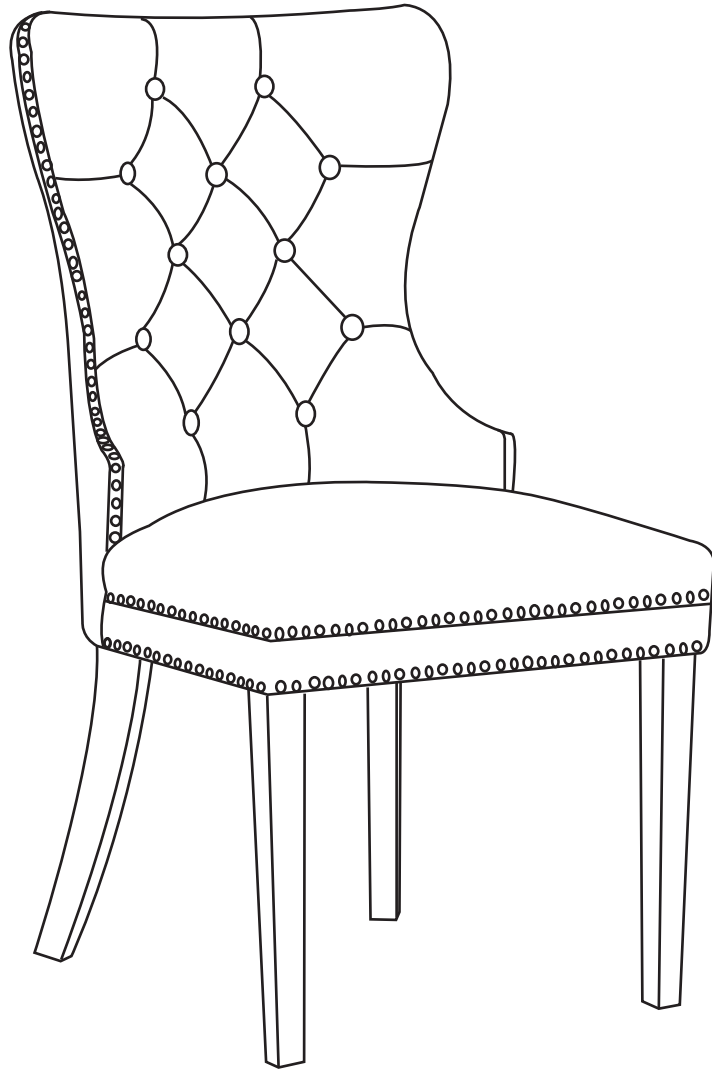

Highland Tufted Velvet Side Chair
SKU: ID305

! CARE & MAINTENANCE

- Be careful when assembly, avoid hurting the paint .
- Clean the dust with lukewarm water, mild detergent & soft cloth.
- Firmly secure all bolts before use, do not use any part of this item as a step ladder.
- Reconfirm that all bolts, screws, and nuts are secure every 90 days.
- Do not use or store this item in the proximity of open flame or flammable/combustible chemicals.

TOOLS REQUIRED



ALLEN WRENCH
(PROVIDED)



300 LBS
CAPACITY



2 PERSONS
ASSEMBLY



UP TO 20 MIN.
ASSEMBLY

HARDWARE

1 Flat washer



Φ8
13PCS

2 Lock washer



Φ8
13PCS

3 Allen Key



M8
1PC

4 Shorter Screw



M8x55MM
8PCS

5 Longer Screws

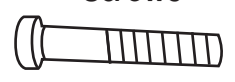

M8x60MM
5PCS

PARTS

A

Back

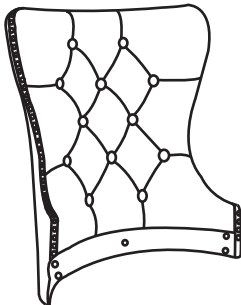

1PC

B

Seat

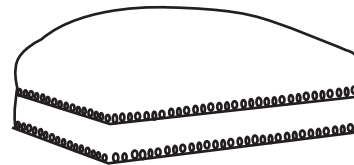

1PC

C

Front Legs

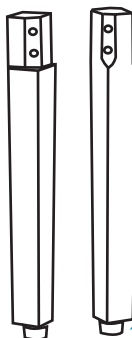

with 2pcs adjustable
feet leveler

2PCS

D

Hind Legs



2PCS

PRODUCT ASSEMBLY

1

Press down the seat when tightening the screw.

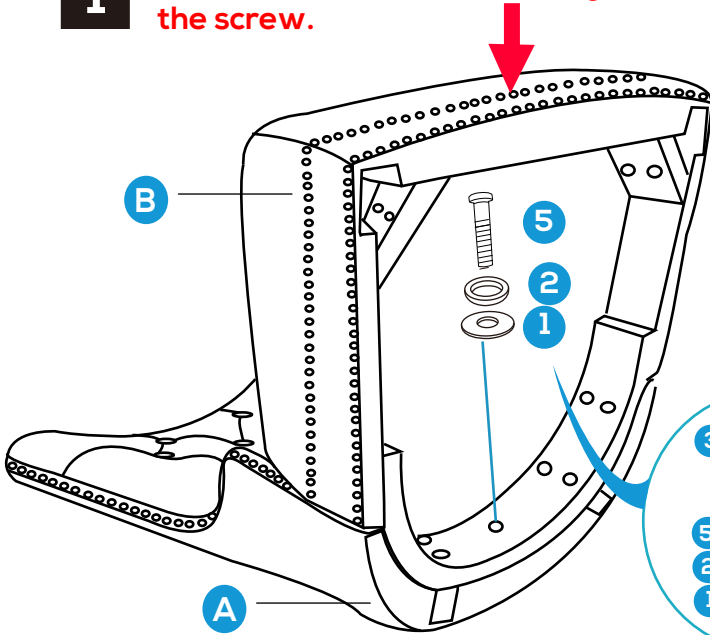

Put chair back on a clean flat surface.

1/ Align the seat in the back pad as shown in the diagram.

2/ Using 1pc of LONGER SCREW (HARDWARE 5) with Washer (HARDWARE 2 & 1).

DO NOT FULLY TIGHTEN.

First HAND tighten then tightened using key up-to 60-80% only at this stage.

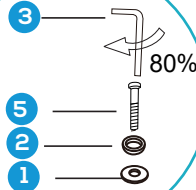

2

B

A

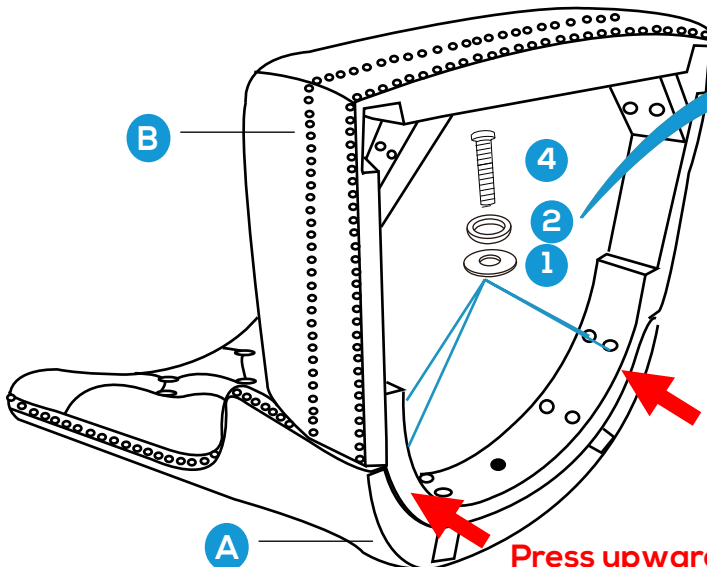

Using 4pcs of SHORTER SCREWS (HARDWARE 4) with Washer (HARDWARE 2 & 1).

DO NOT FULLY TIGHTEN.

First HAND tighten then tightened using key up-to 60-80% only at this stage.

Press upwards the seat when tighten the 4 screws

PRODUCT ASSEMBLY

3

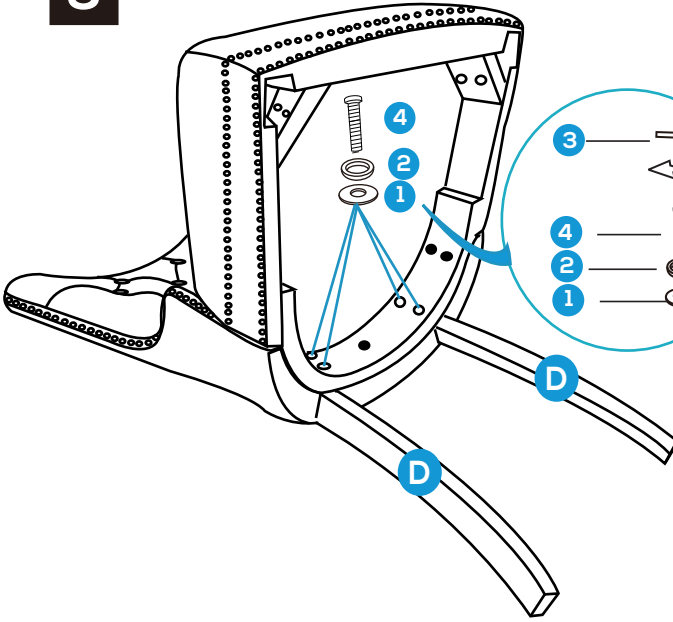

1/ Align PARTS D Hind Legs in the seat pad as shown in the diagram.

2/ Using 4pcs of SHORTER SCREW (HARDWARE 4) with Washer (HARDWARE 2 & 1).

DO NOT FULLY TIGHTEN.

First HAND tighten then tightened using key up-to 60-80% only at this stage.

4

C Front legs

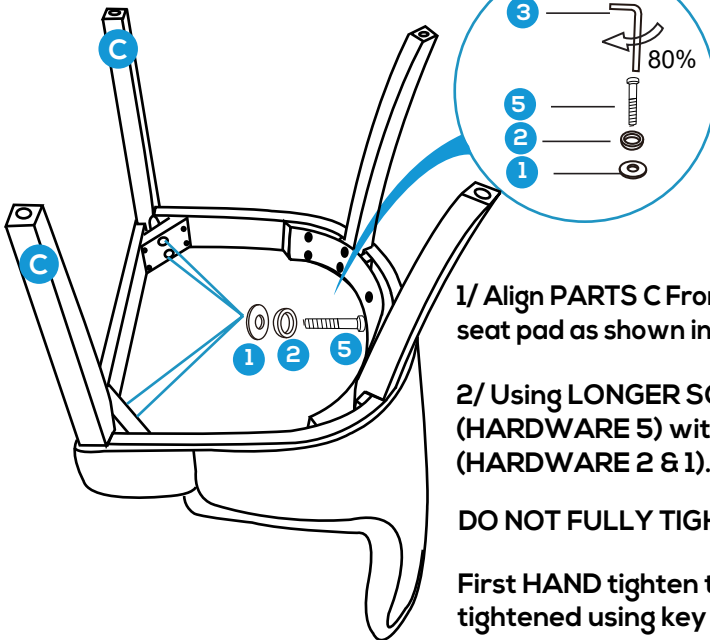
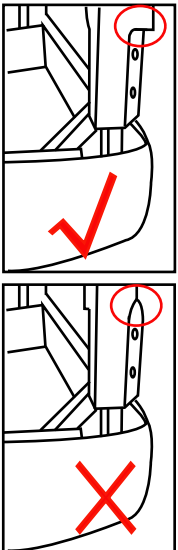

1/ Align PARTS C Front Legs in the seat pad as shown in the diagram.

2/ Using LONGER SCREW (HARDWARE 5) with Washer (HARDWARE 2 & 1).

DO NOT FULLY TIGHTEN.

First HAND tighten then tightened using key up-to 60-80% only at this stage.

PRODUCT ASSEMBLY

5

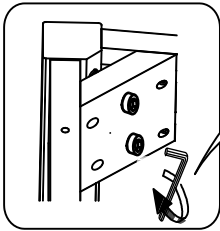
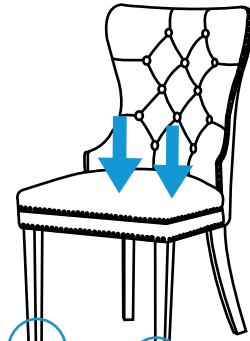
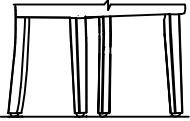
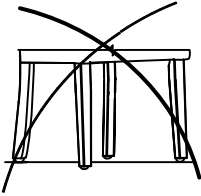

100%

Adjustable Feet Leveler

Put chair in the upright position and **SIT ON THE CHAIR** to press downwards on the seat pad.

Ensuring that all 4 feet touch the ground and chair is leveled.

Proceed to tighten all screws making sure the chair remains level when tightening.

Check that all screws are tight on a regular basis to ensure chair remains level and secure.

Also you can using adjustable feet to keep four legs level .

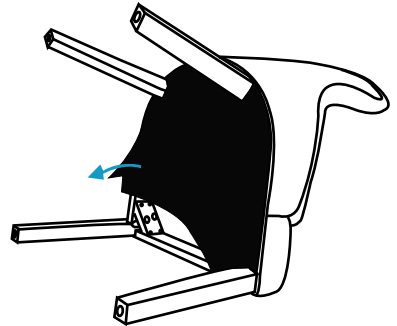

Close the black fabric cover

6

