

# 使用说明书

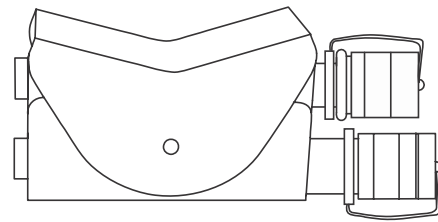

CE

## PVA0021 及 PVA0022 液压控制阀

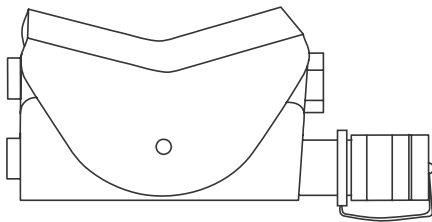

在运行使用或维护本设备装置之前，请阅读并熟悉本使用说明书的所有说明与安全信息。

## 目录

|                           |        |
|---------------------------|--------|
| 描述 .....                  | 2      |
| 安全 .....                  | 2      |
| 本使用说明书要旨 .....            | 2      |
| 主要安全信息 .....              | 3-5    |
| 部件标识 .....                | 6      |
| 规格 .....                  | 6-7    |
| 油管连接 .....                | 8      |
| 典型安装 .....                | 8      |
| 操作 .....                  | 9      |
| 维护 .....                  | 10     |
| 故障排除 .....                | 11-12  |
| 拆卸 .....                  | 13     |
| 检查 .....                  | 13     |
| 装配 .....                  | 14-15  |
| 图解与零件列表 .....             | 16-17  |
| 配件 .....                  | 18-20  |
| 油管和油管总成 (SAE J1273) ..... | s21-22 |

## 说明

Greenlee远程控制阀体积小、重量轻，压力高，额定液压最高达700bar（10000psi）。用于控制靠开中位式液压系统操作的液压工具。

- PVA0021用于单作用工具，采用3/8"接头。
- PVA0022用于双作用工具，采用1/4"接头。

这些四通阀门有三个操作位置：前进、中位和回退。当杆在中位时，特殊保持功能可将工具锁于行程中。

为了减少操作员疲劳，采用了自动弹簧复位杆。这可实现自动关闭及使阀门返回中位，当达到液压系统操作压力或工具在行程末端。

考虑到操作员安全，Greenlee远程控制阀在油回路中有一个卸压阀。如果回流接头未正确连接，该卸压阀将自动打开。卸压压力列于“规格”部分。

另外，PVA0022有一内部卸压阀，其限制工具回退压力。该特征对不能承受345bar（5000 psi）以上的返回侧压力的工具进行保护。

## 安全

在Greenlee工具和设备的使用和维护过程中，安全性是至关重要的。该使用说明书以及装置上的标记提供用以避免与本工具的使用有关的危险和不安全做法的信息。请遵守提供的所有安全信息。

## 本使用说明书要旨

本说明手册旨在让所有人员熟悉下列Greenlee阀门的安全操作、维护和维修程序：

- PVA0021 (50429481)
- PVA0022 (50429491)

对所有人员提供本使用说明书，使之随时可资利用。

如有要求，将免费提供本手册的替换手册。



当工具在运转中或液压流体很热时，勿断开工具、油管或接头。热液压流体可能会导致严重烫伤。

本使用说明书中给出的规格均为标称规格，可随设计的改进予以更改。Greenlee Tools 公司对误用、错用本产品而引起的任何损失损害不负任何责任。

Loctite和 242为Loctite公司的注册商标。

## 保留本使用说明书

**重要安全信息**



**安全  
警示  
符号**

本符号用于提醒您注意可能会带来人身伤害或财产损失的危险或不安全操作。将通过定义如下的文字符号描述危险的严重程度。文字符号后面的信息则是用以防止或避免该危险的发生。

**危险**

瞬时危险将导致严重的人员伤亡。

**警告**

迫切的危险：如果不加以防范，此危险会导致严重的人员伤亡。

**注意**

危险或不安全操作：如果不加以防范，该危险或不安全操作可能导致人身伤害或财产损失。



**警告**

在运行或维护本工具之前，请阅读并理解本使用说明书的所有说明与安全信息。

如不遵守本警告，可能会导致严重的人员伤亡。

**警告**

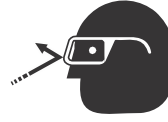

在操作或维护该工具时配戴眼罩。  
不佩戴护眼罩的，飞屑或液压油可能会严重伤害眼部。

**警告**



**触电危险：**

该工具为非绝缘工具。当在通电电线附近使用该装置时，仅用经过检验的非导体油管和正确的人员防护设备。

如不遵守本警告，可能会导致严重的人员伤亡。

**警告**



**皮肤受喷射危险：**

请勿用手检查是否存在泄露。

液压系统加压的时候，请勿手持油管或连接装置。

在进行维护之前，降低液压系统的压力。

油受压后，很容易刺破皮肤，从而严重伤害皮肤，导致皮肤组织坏死甚至死亡。如果你被流出的油所伤，请立即就医。

## 重要安全信息

 警告

使用额定压力为700bar的油管、管件和其它组件。  
不达标组件会在压力下出现故障。  
如不遵守本警告，可能会导致严重的人员伤亡。

 警告

当液压动力源在运转中或液压流体很热时，勿断开阀门、油管或管件。热液压流体可能会导致严重烫伤。

 警告

操作中及操作后阀门和其他组件可能很热。冷却后再进行处置，或戴上隔热手套进行处置。

如不遵守本警告，可能导致严重的人员伤害。

 警告

勿倒转液压流向。液压流反向情况下的操作可能会导致工具故障。将压力（供压）油管和油箱（回流）油管连接至正确接口。

 警告

在阀门与动力源相连时，勿检查、调整或清洁阀门，勿改变配件。

不经意启动可能会造成严重伤害。

如不遵守本警告，可能会导致严重的人员伤亡。

 警告

使用本工具时要佩戴手套。

如不遵守本警告，可能导致严重的人员伤害。

 注意

液压油可能会导致皮肤刺激。

处置阀门和油管时需小心，避免皮肤接触液压油。

如果皮肤接触到液压油，立即洗除感染部位的液压油。

未遵守本要求可能导致人身伤害。

 警告

勿超过下列液压动力源最大值：

液压流量：参见产品规格部分。

勿超过5 l/min (1.32 gpm)。

卸压设置： 138 bar (2000 psi)

回油压力： 13.8 bar (200 psi)

如不遵守本警告，可能会导致严重的人员伤亡。

## 重要安全信息

### 注意

每个工作日须检查液压油管和接头。若出现泄露、破裂、磨损或损坏，应进行修理或更换。受损油管或接头可能会失效，从而带来人身伤害或财产损失。

处置、启动和运转工具时，确保所有旁观者处于工作区域之外。如果工具出现故障。附近人员可能受到飞溅的碎片或零件所伤害。

### 注意

仅将该阀门用于制造商预期的目的。使用情况与该说明书中所描述的不同可能会导致人身伤害或财产损失。

勿试用此阀门操作液压千斤顶。此阀门无此用途。

### 重要

连接或断开液压油管、管件或组件的程序：

1. 将PVA阀设置在中位。
2. 将液压动力源上的流量杆移至OFF位置。
3. 停止液压动力源。
4. 遵守“油管连接”部分的顺序，防止压力增加。若压力已经增加，应缓慢松开油管、管件或组件。

### 重要

应急停止程序：

1. 释放杆。
2. 关闭液压动力源。

*注：保持所有贴花纸清洁易读，必要时进行更换。  
处理任何组件（液压油管、液压流体、磨损部件等）时，应遵守联邦、州及当地法律或法令。*

## 部件标识

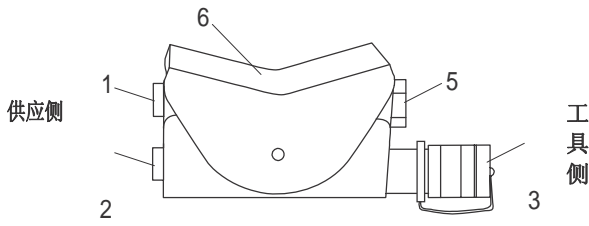

**PVA0021**

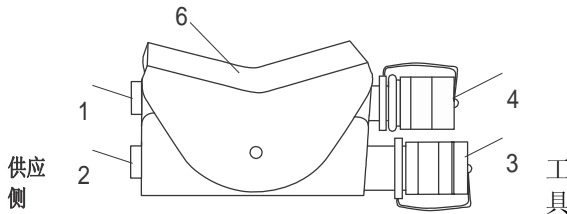

**PVA0022**

1. 回油口
2. 压力口
3. 压力接头
4. 回油接头
5. 塞
6. 杆

## 规格

### PVA0021 液压控制阀

阀类型..... 单作用  
 液压系统类型..... 开中位式  
 工具连接..... 3/8-18 内螺纹快速接头

#### 动力源连接

压力 ..... 1/4-18 NPT  
 油箱..... 1/4-18 NPT

#### 地面倾卸

卸压阀设置.....207 to 276 bar  
 (3000 to 4000 psi)

回油卸压阀设置..... N/A

卸压阀设置..... 700 bar (10,000 psi)

长.....231 mm (9.1")  
 宽.....45 mm (1.75")  
 高.....83 mm (3.25")  
 重量/质量..... 1.3 kg (2.75 lb)

### PVA0022 液压控制阀

阀类型..... 双作用  
 液压系统类型..... 开中位式

#### 工具连接

压力..... 1/4-18 NPSM 内螺纹接头  
 返回..... 1/4-18 NPSM 外螺纹接头

#### 动力源连接

压力 ..... 1/4-18 NPT  
 油箱..... 1/4-18 NPT

#### 地面倾卸

卸压阀设置.....207 to 276 bar  
 (3000 to 4000 psi)

回油卸压阀设置..... 345 bar (5000 psi)

卸压阀设置..... 700 bar (10,000 psi)

长.....191 mm (7.5")  
 宽.....45 mm (1.75")  
 高.....83 mm (3.25")  
 重量/质量..... 1.2 kg (2.5 lb)

## 规格说明（续）

## 液压动力源

|   |
|---|
|  <b>注意</b> |
| 勿超过下列液压动力源最大值：  |
| 液压流量： 参见产品规格部分。<br>勿超过5 l/min (1.32 gpm)。   |
| 卸压设置： 138 bar (2000 psi)  |
| 回油压力： 13.8 bar (200 psi)  |
| 如不遵守本警告，可能会导致严重的人员伤亡。   |

1. 最大液压流体温度不得超过60°C (140°F)。需要足够的油冷却能力以限制液压流体温度。
2. 液压流量不得超过5 l/min (1.32 gpm)。在回流管线中安装一个流量计以在使用工具前测量液压流速。
3. 在您的工具的最大流量下，卸压阀设置不得超过138bar (2000psi)。将卸压阀定位在供应回路中以限制加到工具上的过大液压压力。

**推荐液压流体**

使用符合下列规格或HTMA规格的不含清洁剂的油基液压液。

S.U.S. @

|                     |                      |
|---------------------|----------------------|
| 38 °C (100 °F)..... | 140 to 225           |
| 99 °C (210 °F)..... | 40 (最小)              |
| 闪点.....             | 170 °C (340 °F) (最小) |
| 倾点.....             | -34 °C (-30 °F) (最小) |

|                  |                    |
|------------------|--------------------|
| 液压系统类型.....      | 开中位式               |
| 卸压设置.....        | 138 bar (2000 psi) |
| 回油压力(最大值)* ..... | 13.8 bar (200 psi) |
| 过滤.....          | 10 Micron (公称)     |

13.8bar (200psi) 为HTMA (液压工具制造协会) 可接受的最大标准回油压力。  
Greenlee工具在此标准下操作会非常稳定。

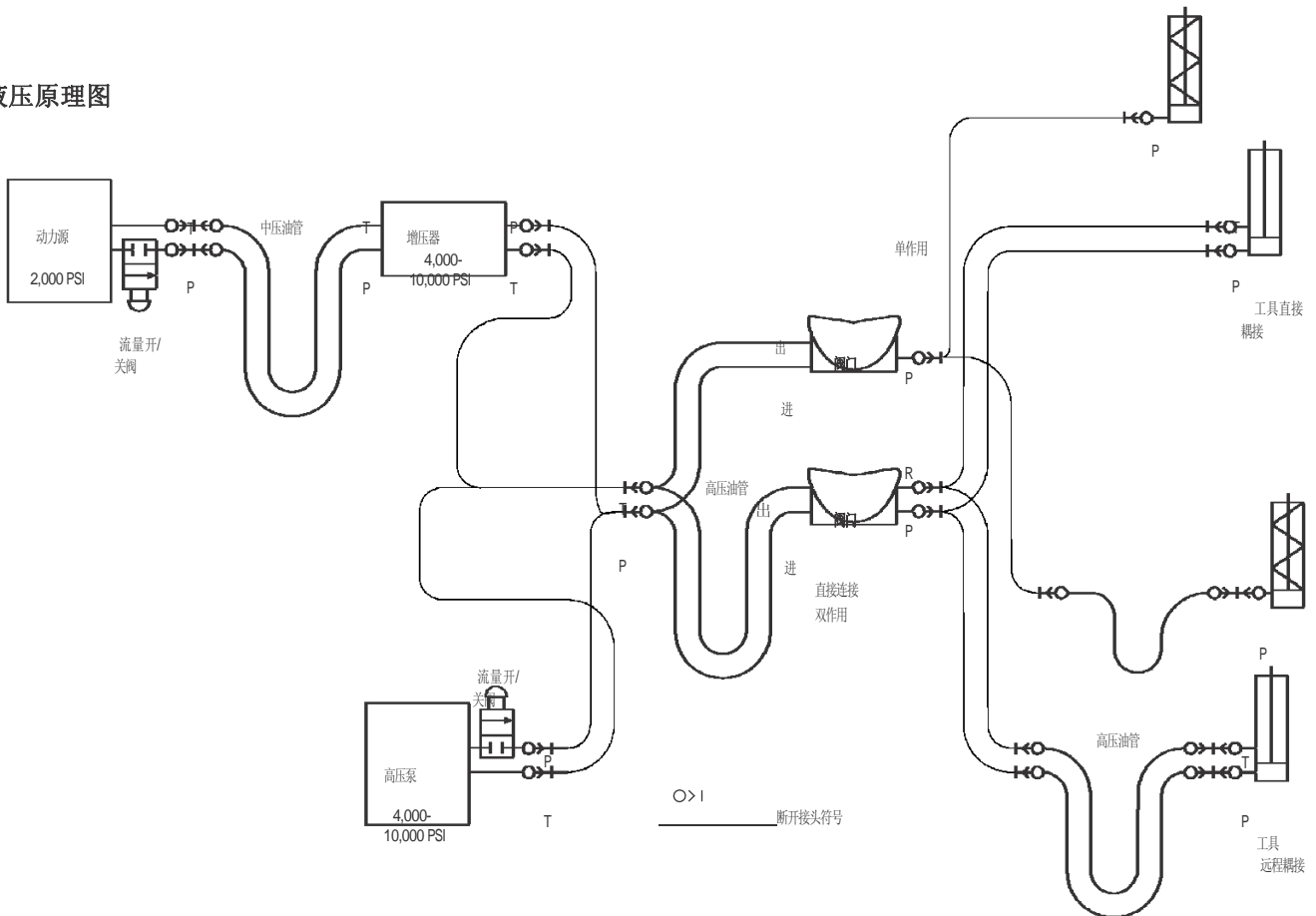
**液压原理图**

**油管连接**

**连接油管**

1. 将液压动力源上的流量杆移至OFF位置。
2. 停止液压动力源。
3. 按所示顺序连接油管。

**断开油管**

1. 将液压动力源上的流量杆移至OFF位置。
2. 停止液压动力源。
3. 按所示顺序断开油管。
4. 安装防尘盖。

注：回流（油箱）油管连接应始终连接，然后再将供应（压力）油管连接，以阻止装置内压力增加。

**典型配置**

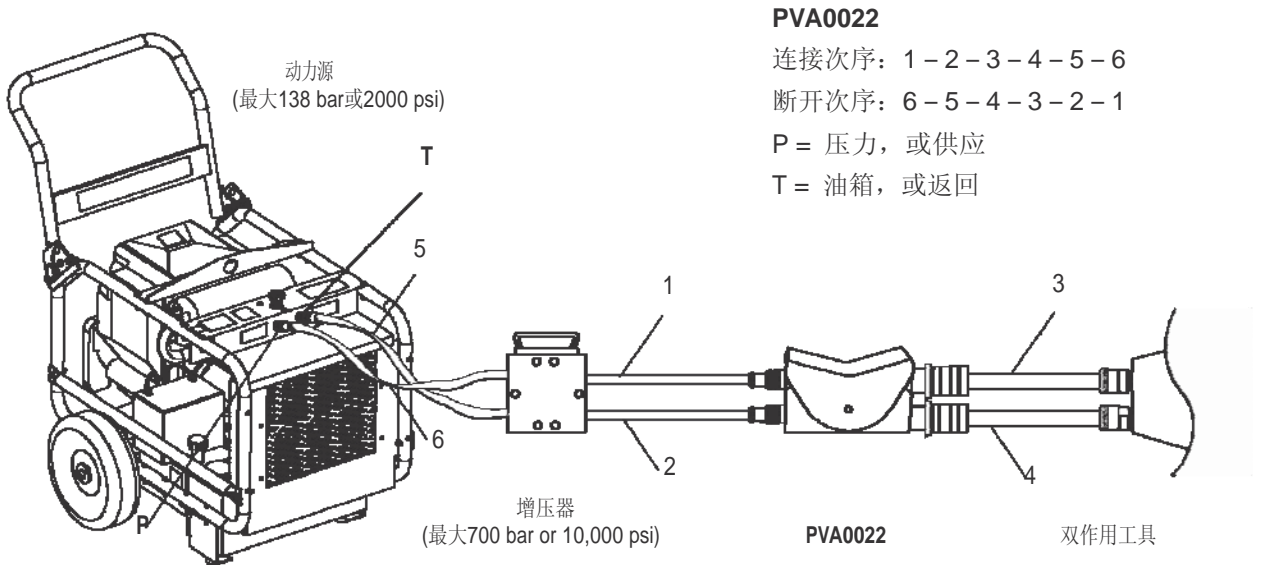
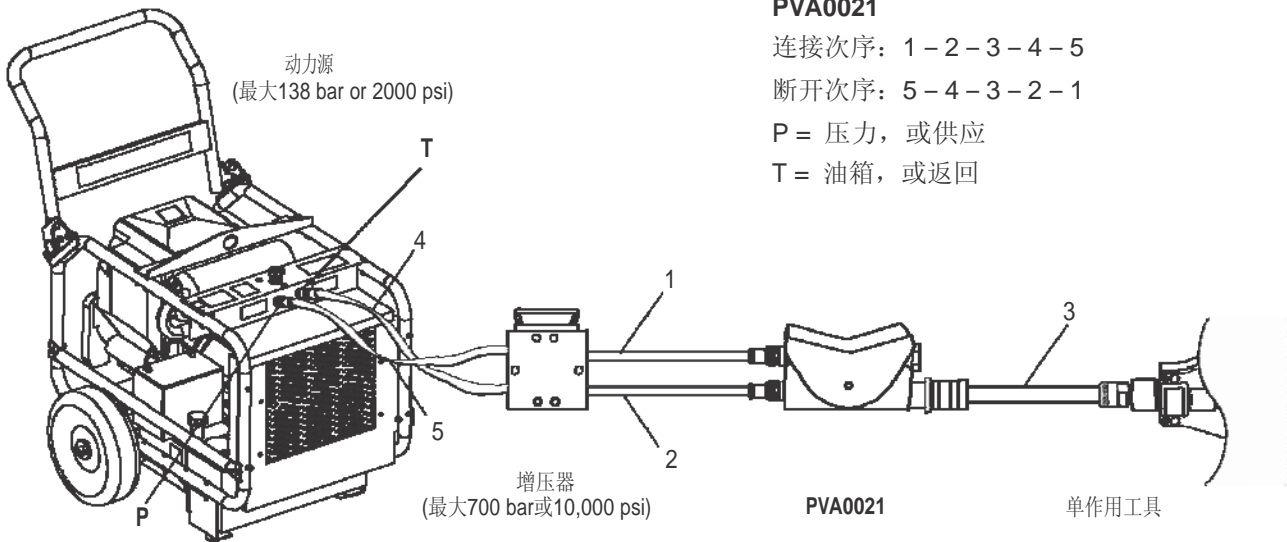



**操作**

|   |   |
|---|---|
|  | <b>⚠ 注意</b>   |
|   | <p>触电危险：</p> <p>该工具为非绝缘工具。当在通电电线附近使用该组件时，应只用经验证的非导体油管和使用正确的人员防护设备。</p> <p>如不遵守本警告，可能会导致严重的人员伤亡。</p> |

|  |   |
|--|---|
|  | <b>⚠ 注意</b>   |
|  | <p>操作中及操作后阀门和其他组件可能很热。冷却后再进行处置，或戴上隔热手套进行处置。</p> <p>如不遵守本警告，可能导致严重的人员伤害。</p> |

*注：使用工具时保持正确的脚步和平衡。不得延伸过远。不适合的底脚和平衡可能会使抵消作用不正常，或者出现工具意外移动。*

1. 启动液动力源。

*注：让动力源运行几分钟使液压流体变暖。*

2. 将工具置于合适的地点或位置。
3. 要开启工具，将杆压至前进位置。

*注：*

*当液压达到207bar至276bar（3000psi至4000psi），可以释放杆，杆将保持在前进位置上。此工具将继续前进直至增压器达到700bar（10000psi）。*

*可将杆压至中位而随时停止工具。*

4. 要使工具回退，将杆压至回退位置。
5. 不使用工具时，停止动力源以减少工具组件上的发热和磨损。

|  |  |
|--|--|
|  | <b>⚠ 注意</b>  |
|  | <p>皮肤受喷射危险：</p> <p>请勿用手检查是否存在泄露。</p> <p>液压系统加压的时候，请勿手持油管或连接装置。</p> <p>在进行维护之前，降低液压系统的压力。</p> <p>油受压后，很容易刺破皮肤，从而严重伤害皮肤，导致皮肤组织坏死甚至死亡。如果你被流出的油所伤，请立即就医。</p> |

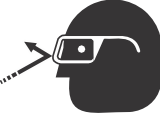
|   |  |
|---|--|
|  | <b>⚠ 注意</b>  |
|   | <p>在操作或维护该设备时配戴眼罩。</p> <p>不佩戴护眼罩的，飞屑或液压油可能会严重伤害眼部。</p> |

|  |
|--|
| <b>⚠ 注意</b>  |
| <p>使用额定压力为700bar的油管、管件和其它组件。不达标组件会在压力下出现故障。</p> <p>如不遵守本警告，可能会导致严重的人员伤亡。</p> |

## 维护

|   |  |
|---|--|
|  | <b>⚠ 注意</b>                                  |
|   | 在操作或维护该设备时请配戴眼罩。<br>若不佩戴护眼罩，飞屑或液压油可能会严重伤害眼部。 |

|   |
|---|
| <b>⚠ 注意</b>   |
| 在与动力源相连时，勿检查、调整或清洁工具，勿改变配件。不经意启动可能会造成严重伤害。<br>如不遵守本警告，可能会导致严重的人员伤亡。 |

注：保持所有贴花纸清洁易读，必要时进行更换。

处理任何组件（液压油管、液压流体、磨损部件等）时，应遵守联邦、州及当地法律或法令。

使用此维护日程以获得最长的工具使用寿命。

## 每日

1. 擦净工具所有表面。
2. 检查液压油管和管件，查看泄露、破裂、磨损或损坏迹象。必要时进行更换。
3. 工具断开时安装防尘盖。

## 每月

1. 按照本手册末尾或出版物99930323，SAE J1273中的“油管及油管总成”所述，对液压油管和管件进行彻底检查。
2. 在阀门和工具之间安装一个管线压力计以检查加到工具上的压力，压力计额定压力为700bar（10000psi）。

## 每年

如您的公司需要，让Greenlee授权服务中心对其进行检修。

## 故障排除

### 隔离工具或油管

故障排除之前，确认问题在工具、油管还是动力源。用一个工具或高压油管，其工作状态完好，来进行替换，以剔除不能运转的部件。如果问题在工具上，参见随工具提供的手册中的故障排除表。如果问题在油管上，更换油管。

### 隔离阀门和液压动力源

1. 停止液压动力源。
2. 从泵的油箱（回流）接口处断开油箱（回流）油管。安置好油管，让所有流体流入废物容器。
3. 将PVA阀设置在中位。
4. 启动液压动力源。

如果液压流体从断开的回流油管流出，按第5步操作。

如果液压流体未从断开的回油管中流出，核实泵是否工作正常。如果泵工作正常，故障组件可能是油管或PVA阀门。用工作正常的高压油管进行替换。如果问题在PVA阀门，参见本手册故障排除表，或将PVA阀送至Greenlee授权服务中心。

5. 将阀门设置到前进位置。

如果液压流体从断开的回流油管中流出，故障组件可能是PVA阀门。参见本手册的故障排除表，或将PVA阀门送至Greenlee授权服务中心。

如果液压流体未从断开的回油管中流出，故障可能位于泵或增压器。参见对应手册获取适当故障排除方法。

| 问题                | 可能原因                | 可用补救措施                       |
|-------------------|---------------------|------------------------------|
| PVA杆卡住或粘住。        | 杆下的污物、粘性沉积物或其它污染物。  | 清洁杆下区域。                      |
|                   | 阀簧卡住、粘住或断裂。         | 清洁或更换阀簧。                     |
| 液压流体从地面倾卸卸压阀接口流出。 | 油箱（回流）接头未正确连接。      | 断开接头，重新正确连接。                 |
|                   | 某系统组件的某个油箱（回流）接头损坏。 | 更换损坏的接头。                     |
|                   | 远程控制阀未正确连接。         | 将压力（供压）油管和油箱（回流）油管连接至正确接口。   |
|                   | 地面倾卸卸压阀阻塞。          | 清洁或更换地面倾卸卸压阀组件。装配阀门并调节设置。    |
| 工具不能前进。           | 远程控制阀密封位于阀封孔中。      | 拆卸阀门，重新配置阀密封。装配阀门并调节设置。      |
|                   | 远程控制阀泄露液压流体。        | 拆卸阀门，更换O形环和备用环。装配阀门并调节设置。    |
|                   | 回流卸压阀阻塞。            | 拆开阀门，清洁或更换回流卸压阀组件。装配阀门并调节设置。 |

**故障排除（续）**

| 问题                                    | 可能原因               | 可用补救措施                     |
|---------------------------------------|--------------------|----------------------------|
| 工具不能回退。                               | 远程控制阀密封位于阀封孔中。     | 拆卸阀门，重新配置阀密封。装配阀门并调节设置。    |
| 杆在达到操作压力后不返回中位。                       | 杆下的污物、粘性沉积物或其它污染物。 | 清洁杆下区域。                    |
|                                       | 某些杆组件粘住或损坏。        | 拆开杆进行清洁或更换故障组件。            |
|                                       | 液压油不热。             | 让流体变暖至操作温度。间歇地启动工具以减少变暖时间。 |
|                                       | 复位弹簧粘住或断裂。         | 拆开杆进行清洁或更换故障组件。            |
|                                       | 控制阀未正确调节；杆挡块未正确对准。 | 拆开杆和挡块。调节和对准。              |
|                                       | 泵或增压器卸载阀未释放。       | 参见对应于那些件的指南。               |
| 工具可以前进、建立压力和回退，但是压力不够足，不能完成作业（压接电缆等）。 | 阀门和工具之间的压力接头连接不完全。 | 拧紧接头连接。                    |
| 远程控制阀在控制杆两侧都建立压力，但是无液压油流向工具。          | 阀盘组件总成未正确安装。       | 拆卸阀门。拆除阀盘并旋转180°。          |
|                                       | 阀门和工具之间的压力接头连接不完全。 | 拧紧接头连接。                    |

## 拆卸

不建议完全拆卸该工具。

如果需要大修，请将工具返回最近的Greenlee授权服务中心。

拆卸程序细分为工具各个部分。请仅拆卸完成修理所需部分。

应在平坦清洁的表面拆卸工具。小心勿遗失或损坏任何拆卸中随时可脱落的零件。

### PVA0021: 塞子、接头和转换接头

1. 从阀体 (21) 上拆除转换接头 (25) 和铜质垫圈 (31)。
2. 使用一个O型圈工具从母接头 (26) 上拆除内部O形圈 (27)。
3. 拆除塞子 (24) 和铜质垫圈 (31)。

### PVA0022: 接头

1. 从阀体 (21) 上拆除转换接头 (29, 30) 和铜质垫圈 (31)。
2. 使用一个O形圈工具从母接头 (30) 上拆除内部O形圈 (32)。

### 杆和弹簧

1. 从杆 (1) 上拆除两个螺钉(3)。  
伸展杆的两侧，将其从阀体 (21) 上拆下。
2. 使用一对手钳握住踏板档块 (15)。  
拆下螺钉(14)和压力弹簧(16)。
3. 对另一个档块、螺钉和弹簧重复第2步。

### 阀盖

*注： 阀盘组件 (8) 的轴中槽口使阀盘组件与阀体 (21) 对准； 组装时标记阀盘组件以正确对准。*

1. 使用活动扳手松开阀盖 (4)。  
*注： 拆除阀盖时不得让阀盘旋转。*
2. 拆除阀盖 (4)， 止推座圈 (6) 和止推轴承 (7)。
3. 从阀盖上拆除O形圈 (5)。

### 阀盘

*注： 阀盘背后的孔必须正确对准以正确装配。 标记阀盘末端以正确对准。*

1. 从阀体 (21) 上拆除阀盘组件 (8)。
2. 从阀盘总成上拆除两个O形圈 (9)。  
*注： 不得拆除压在一起的阀盘组件。*

### 剪切密封

*注： 拆除前在阀体中对每个剪切密封的位置进行标记。*

1. 拆除这三个剪切密封(10)和压力弹簧(13)。
2. 从每个密封上拆除O形圈 (12) 和支承环 (11)。

### PVA0021: 接口塞

1. 从阀体上拆除这两个凹头定位螺钉 (33)。
2. 从阀体上拆除接口塞 (17)。

### PVA0022: 回流泄压阀

1. 松开这两个凹头定位螺钉 (33)。
2. 拆除压缩弹簧 (20) 和阀销 (19)。

### 地面倾卸泄压阀

1. 松开这两个凹头定位螺钉 (18)。
2. 拆除压缩弹簧 (20) 和阀销 (19)。

## 检查

用适当清洁剂清洁所有零件并彻底干燥。按本节所述检查各部件。更换所有出现磨损和损坏的组件。

1. **止推轴承 (7)：** 将止推轴承 (7)、止推座圈 (6) 和阀盘组件 (8) 插入到阀盖 (4) 中。将盖握在一只手中，另一只手旋转阀盘。运动必须平滑无粗糙点。如果不平滑，应更换轴承和座圈。
2. **阀体 (21)， 阀盘组件 (8)， 阀盖 (4)：** 检查吻合表面、钻孔、油管等有无凹槽或凹口。
3. **剪切密封 (10) 和压缩弹簧 (13)：** 将压缩弹簧和剪切密封安装至其接口内。推入每个剪切密封，然后释放。剪切密封应受弹簧力而返回，不会卡住或粘在阀体中。
4. **阀销 (19) 和PVA阀体：** 阀销必须完全密封。如果未完全密封，用快的钻尖将阀座打磨再重装。
5. **止推环：** 更换任何不圆的止推环。
6. 检查所有其他拆开的组件有无裂痕、凹槽或凹口。

## 装配

### 重要

这些液压控制阀是高压组件，最大压力达700bar (10000psi)。严格遵守装配和调节须知，使阀门可以正确操作。

参见图解和零件清单以便正确定向和安置各零件。

更换已拆卸零件的所有O形圈和铜质垫圈。对所有O形圈及O形圈必须滑动的金属表面涂覆液压油或O形圈润滑剂。当安装须在尖锐表面滑动的O形圈时，采用滚动运动，注意勿损坏O形圈。

无论什么地方，只要装配是有金属间直接接触，均应用液压油或O形圈润滑剂涂抹表面。

装配程序的某些步骤需要可拆型螺纹密封和紧固剂，例如Loctite® 242® 或类似物。遵守制造商的固化指南。

### 剪切密封

注：在原来的钻孔中安装每个剪切密封。

1. 给每个密封装配一个挡圈（11）和一个O形圈（12）。对O形圈涂润滑油。
2. 在阀体（21）上安装三个压缩弹簧（13）和三个剪切密封（10）。

### 阀盘

1. 给阀盘组件（8）安装两个O形圈（9）。
2. 给阀体（21）装配阀盘组件。  
使用在拆卸过程中作的标记以进行正确对准。

### 阀盖

1. 给阀盖（4）装配O形圈（5）。
2. 给阀盖（4）装配止推座圈（6）和止推轴承（7）。
3. 用一对夹钳将阀盘组件（8）夹持在位，将阀盖总成拧到阀盘组件的轴上。使用活动扳手拧紧阀盖。  
注：如果在此步骤中阀盘组件旋转，则说明该组件功能不正常。

### 杆和弹簧

注：第1步需要螺纹紧固剂，该剂用于金属构件，其将按第7步来调节。准备好工具和组件以使能在紧固剂硬化前完成此程序。

1. 将一种可拆型螺纹密封和紧固剂，例如Loctite® 242® 或类似物，涂在内六角头螺钉（14）上。遵守制造商的固化指南。
2. 在阀体（21）中安装一个内六角螺钉（14）。装配一个压缩弹簧（16）和踏板挡块（15）。拧紧内六角螺钉（14）。
3. 对另一个挡块、螺钉和弹簧重复第2步。
4. 给阀体（21）上安装阀杆（1），并用两个螺钉（3）固定。
5. 安装橡胶罩（23）。给橡胶套四周涂抹一滴胶水。
6. 将阀杆设置在中位。使这两个螺钉（14）均等后退直至踏板挡块（15）轻轻接触阀杆。

### PVA0021: 塞子、接头和转换接头

注：如果转换接头（25）和内螺纹接头（26）被拆卸，用与液压油兼容的螺纹密封剂进行装配。但是不得使用螺纹密封剂来给阀体装配转换接头。

1. 使用一个O形圈工具将内部O形圈（27）安装到接头（26）中。
2. 给阀体（21）安装配有新铜质垫圈（31）的转换接头（25）。将扭矩加至27 Nm至32 Nm (20 ft-lb至24 ft-lb)。
3. 给阀体（21）安装配有新铜质垫圈（31）的塞子（24）。将扭矩加至27 Nm至32 Nm (ft-lb至24 ft-lb)。

### PVA0022: 接头

注：此程序需要使用一个兼容工具或者一个装配量规（Greenlee 号50407711，单独购买）。

1. 使用一个O形圈工具将内部O形圈（32）安装到内螺纹接头（30）中。
2. 将转换接头（29, 30）连同铜质垫圈（31）拧到阀体（21）上。不得拧紧接头。
3. 使用兼容工具或装配量规，方法如下：  
如图所示，将工具连至装置。

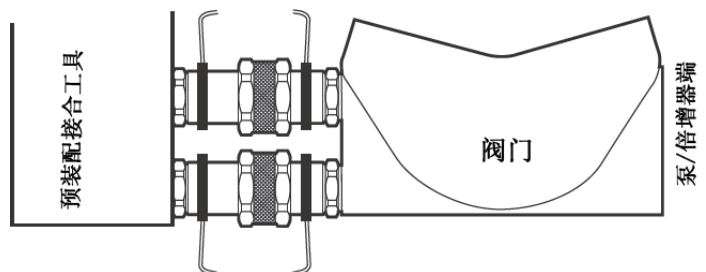

## 装配（续）

把装配量规固定在虎钳中。将装置与装配量规相配合，使外螺纹接头位于孔中，内螺纹接头在销的上方。

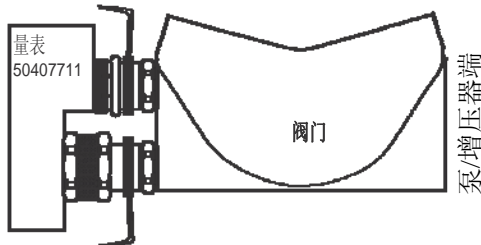

4. 拧紧接头—均匀地进行、每圈后交替—直至两个接头稳固拧紧。将扭矩加至27 Nm至32 Nm (ft-lb至24 ft-lb)。

### PVA0021: 接口塞

1. 在接口T中安装接口塞（17）。
2. 安装并拧紧这两个凹头定位螺钉（33）。

### PVA0022: 回流卸压阀

1. 在接口R中安装阀销（19）。轻轻敲击阀销末端以就座。
2. 安装压缩弹簧（20）。
3. 将可拆型螺纹密封和紧固剂，例如Loctite® 242® 或类似物，涂在一个凹头定位螺钉上。遵守制造商的固化指南。
4. 使用一个高压油管和一个压力计将动力源连接至供应压力接口。
5. 定位该装置，使供应端指向一个屏蔽板，如一块金属片，用一个盘接住所有漏下的液压流体。将阀杆置于中位。
6. 启动液压动力源。逐步增加液压直至油从凹头定位螺钉（33）中溅出。油开始溅出时记下压力计的压力读数。
7. 关闭动力源，降低液压系统压力。
8. 如果当油开始溅出时液压在指定卸压范围（354至372bar（5000至5400psi））内，则进行第10步。否则，进行第9步。
9. 如要调节设置：  
顺时针转动定位螺钉以增加卸压设定值。  
逆时针转动定位螺钉以减少卸压设定值。

10. 重复第6-9步直至设定值在指定范围内。安装第二个凹头定位螺钉（33）并对着第一个凹头定位螺钉拧紧。
11. 重复第6步以确保设定值未受第10步干扰。

### 地面倾卸卸压阀

1. 将阀销（19）安装至阀体（21）上的中心通道中。用销子冲头轻轻敲击阀销杆部（19）。插入压缩弹簧（20）。
2. 将一种可拆型螺纹密封和紧固剂，例如Loctite® 242® 或类似物，涂在一个凹头定位螺钉（33）上。遵守制造商的固化指南。
3. 使用一个高压油管和一个压力计将动力源连接至供应压力接口。
4. 从PVA阀上断开返回管线，使接头就位以堵塞接口。
5. 定位该装置，使供应端指向一个屏蔽板，如一块金属片，用一个盘接住所有漏下的液压流体。将阀杆置于中位。
6. 启动液压动力源。使踏板处于中位，逐步增加液压直至油从凹头定位螺钉（33）中溅出。油开始溅出时记下压力计的压力读数。
7. 关闭动力源，降低液压系统压力。
8. 如果当油开始溅出时液压在指定卸压范围（207至276bar（3000至4000psi））内，则进行第10步。否则，进行第9步。
9. 如要调节设置：  
顺时针转动定位螺钉以增加卸压设定值。  
逆时针转动定位螺钉以减少卸压设定值。
10. 重复第6-9步直至设定值在指定范围内。安装第二个凹头定位螺钉（33）并对着第一个凹头定位螺钉拧紧。
11. 重复第6步以确保设定值未受第10步干扰。

图解

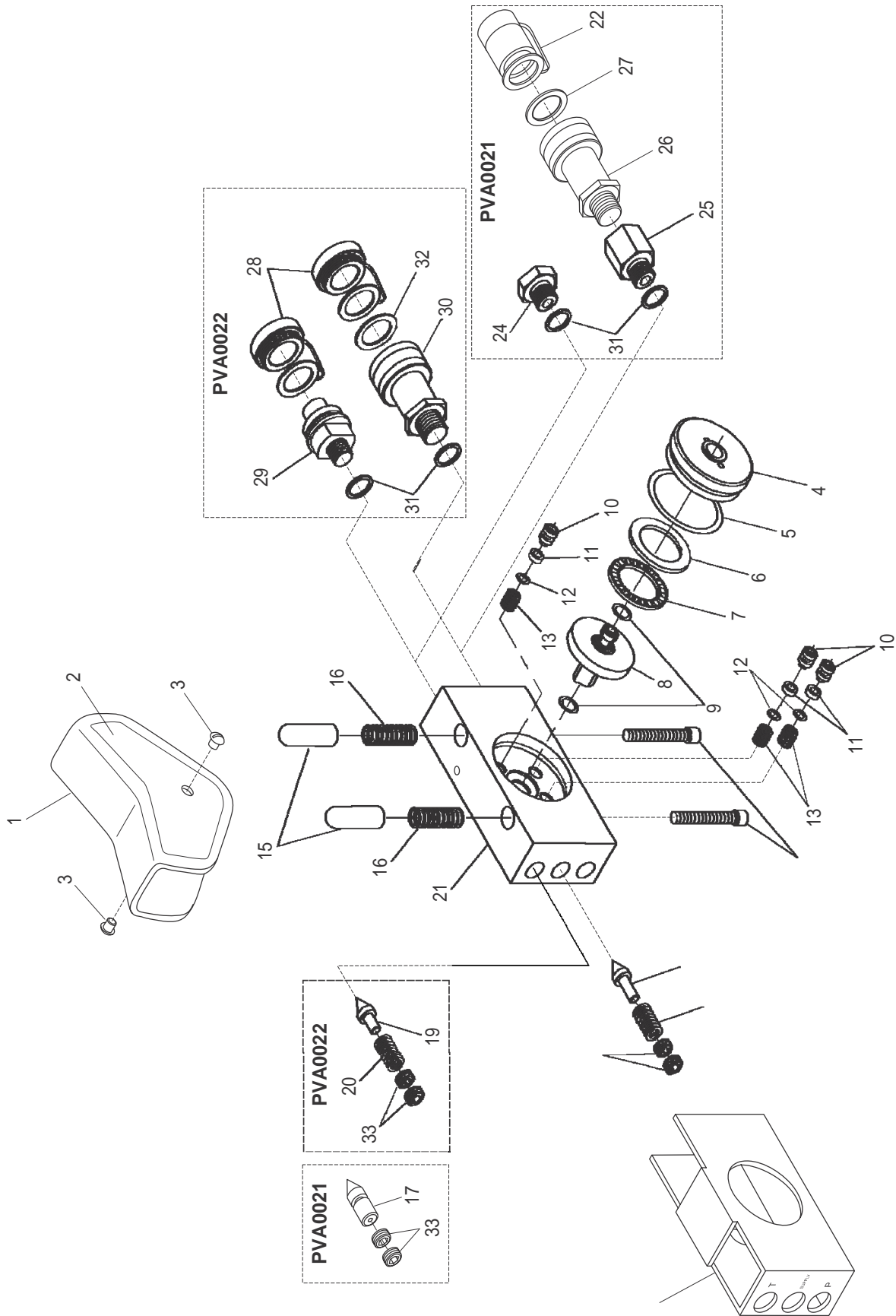



**零部件清单**

| 序号  | UPC编号    |          | 描述  | 数量      |         |
|-----|----------|----------|---|---------|---------|
|     | 78-3310- | 零件编号     |   | PVA0021 | PVA0022 |
| 1   | 43459    | 50434594 | 带警示贴花纸(下一项)的阀杆 .....                      | 1       | 1       |
|     | 43460    | 50434608 | 警示贴花纸 (未显示) .....                         | 1       | 1       |
| 2   | 43461    | 50434616 | 部件标识的贴花纸 .....                            | 1       | 0       |
| 2   | 43462    | 50434624 | 部件标识的贴花纸 .....                            | 0       | 1       |
| 3   | 48703    | 50487035 | 有槽圆头螺钉, #8-32 x .250 .....                | 2       | 2       |
| 4   | 43465    | 50434659 | 阀盖 .....                                  | 1       | 1       |
| 5*  | 43262    | 50432621 | O-型环, 1.75 x 1.875 x .062-70 .....        | 1       | 1       |
| 6   | 42017    | 50420173 | 止推座圈, 1.002 x 1.552 x .032 .....          | 1       | 1       |
| 7   | 43467    | 50434675 | 止推轴承, 1.005 x 1.547 x .078 .....          | 1       | 1       |
| 8   | 43468    | 50434683 | 阀盘组件 .....                                | 1       | 1       |
| 9   | 43469    | 50434691 | O形圈, .250 x .375 x .062-70 .....          | 2       | 2       |
| 10  | 43470    | 50434705 | 剪切密封 .....                                | 3       | 3       |
| 11* | 43049    | 50430491 | 单匝支撑环, .140 x .246 x .048 .....           | 3       | 3       |
| 12* | 41844    | 50418440 | O形圈, .125 x .250 x .062-70 .....          | 3       | 3       |
| 13* | 43471    | 50434713 | 压缩弹簧 .....                                | 3       | 3       |
| 14  | 43472    | 50434721 | 内六角圆柱头螺钉, #10-32 x 1.75 .....             | 2       | 2       |
| 15  | 43473    | 50434730 | 踏板挡块 .....                                | 2       | 2       |
| 16  | 43474    | 50434748 | 压缩弹簧 .....                                | 2       | 2       |
| 17  | 43475    | 50434756 | 接口塞 .....                                 | 1       | 0       |
| 18  | 43476    | 50434764 | 凹头定位螺钉, 3/8-24 x .187, .....              | 2       | 2       |
| 19  | 30146    | 50301462 | 阀销, .305 x .870 .....                     | 1       | 2       |
| 20  | 48234    | 50482343 | 压缩弹簧, .190 x .318 x 1.088 .....           | 1       | 2       |
| 21  | 43477    | 50434772 | PVA阀体 .....                               | 1       | 1       |
| 22  | 41830    | 50418301 | 防尘盖 .....                                 | 1       | 0       |
| 23  | 43478    | 50434780 | 橡皮套 .....                                 | 1       | 1       |
| 24  | 40764    | 50407641 | 塞, 1/4-18 NPSM .....                      | 1       | 0       |
| 25  | 40748    | 50407481 | 转换接头, 3/8-18 NPTF转换成1/4-18 NPSM F/M ..... | 1       | 0       |
| 26  | 41877    | 50418771 | 内螺纹接头 .....                               | 1       | 0       |
| 27* | 42030    | 50420304 | O形圈, .750 x 1.00 x .125-90 .....          | 1       | 0       |
| 28  | 41834    | 50418341 | 防尘盖 .....                                 | 0       | 2       |
| 29  | 40647    | 50406471 | 外螺纹接头, 1/4-18 NPSM .....                  | 0       | 1       |
| 30  | 40652    | 50406522 | 内螺纹接头, 1/4-18 NPSM .....                  | 0       | 1       |
| 31  | 40646    | 50406461 | 平垫圈, .514 x .030, 铜制 .....                | 2       | 2       |
| 32* | 41842    | 50418421 | O形圈 .....                                 | 0       | 1       |
| 33  | 54643    | 90546431 | 凹头定位螺钉, 7/16-20 .....                     | 2       | 2       |
| *   | 43479    | 50434799 | 封装套件(包括标有星号项)                             |         |         |

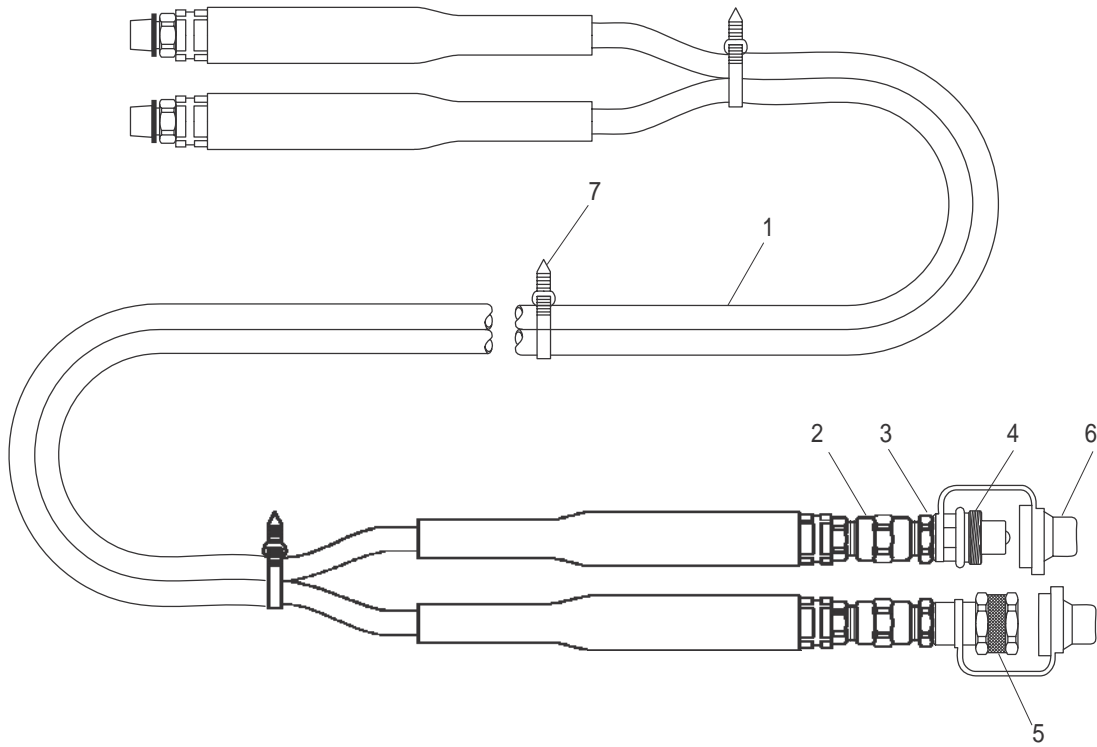
**配件**
**700bar (10000psi) 高压授权使用绝缘油管**

| UPC 编号<br>序号                             | 78-3310-<br>零件编号 | 描述  | 数量 |
|--|------------------|---|----|
| <b>整套油管总成, 额定压力为700 bar (10,000 psi)</b> |                  |   |    |
| 41107                                    | 50411074         | 6 ft (包括1-7项) .....                       | 1  |
| 41108                                    | 50411083         | 10 ft (包括1-7项) .....                      | 1  |
| <b>油管, 额定压力为700 bar (10,000 psi)</b>     |                  |   |    |
| 1  | 41795            | 50417951 6 ft, 1/4 MNPT x 1/4 MNPT .....  | 1  |
| 1  | 41796            | 50417961 10 ft, 1/4 MNPT x 1/4 MNPT ..... | 1  |

| UPC 编号<br>序号 | 78-3310-<br>零件编号 | 描述   | 数量 |
|--------------|------------------|--|----|
| <b>接头和管件</b> |                  |  |    |
| 2            | 41401            | 50414014 接头, 1/4 FNPT x 1/4 FNPT .....     | 2  |
| 3            | 41344            | 50413442 转换接头, 1/4 MNPT x 1/4 MNPT .....   | 1  |
| 4            | 41811            | 50418112 外螺纹接头, 1/4 FNPT .....             | 1  |
| 5            | 42096            | 50420961 内螺纹接头, 1/4 MPNT .....             | 1  |
|              | 41842            | 50418421 O形圈, 5/8 x 13/16 x 3/32-90D ..... | 1  |
| 6            | 41834            | 50418341 防尘盖 .....                         | 2  |
| 7            | 41587            | 50415870 Ty-Rap扎带 .....                    | 3  |

## 配件（续）

## 700bar（10000psi）高压接头

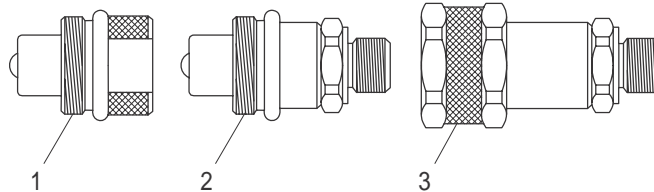

| 序号 | UPC 编号<br>78-3310- | 零件编号  | 描述   | 数量 |
|----|--------------------|---|--|----|
| 1  | 41811              | 50418112                                      | 外螺纹接头, 1/4 FNPT.....                               | 1  |
|    | 41941              | 50419411                                      | 外螺纹接头, 3/8 FNPT.....                               | 1  |
| 2  | 40647              | 50406471                                      | 外螺纹接头, 1/4 MNPS .....                              | 1  |
|    | 40646              | 50406461                                      | 铜质垫圈.....  | 1  |
| 3  | 42096              | 50420961                                      | 内螺纹接头, 1/4 MNPT.....                               | 1  |
|    | 41842              | 50418421                                      | O形圈, 5/8 x 13/16 x 3/32-90 .....                   | 1  |
|    | 40652              | 50406522                                      | 内螺纹接头, 1/4 MNPS .....                              | 1  |
|    | 41842              | 50418421                                      | O形圈, 5/8 x 13/16 x 3/32-90 .....                   | 1  |
|    | 40646              | 50406461                                      | 铜垫圈 .....  | 1  |
|    | 41877              | 50418771                                      | 内螺纹接头, 3/8 MNPT<br>(Pioneer或Bruning).....          | 1  |
|    | 42030              | 50420304                                      | O形圈, .734 x 1.012 x .139-90<br>(仅限于Pioneer接头)..... | 1  |
|    | 41372              | 50413722                                      | O形圈, .737 x .943 x .103-70<br>(仅限于Bruning接头).....  | 1  |
|    | 52000678           | 挡圈, .759 x .929 x .085<br>(仅限于Bruning接头)..... | 1  |    |

## 配件 (续)

测试低压系统的流量测试套件

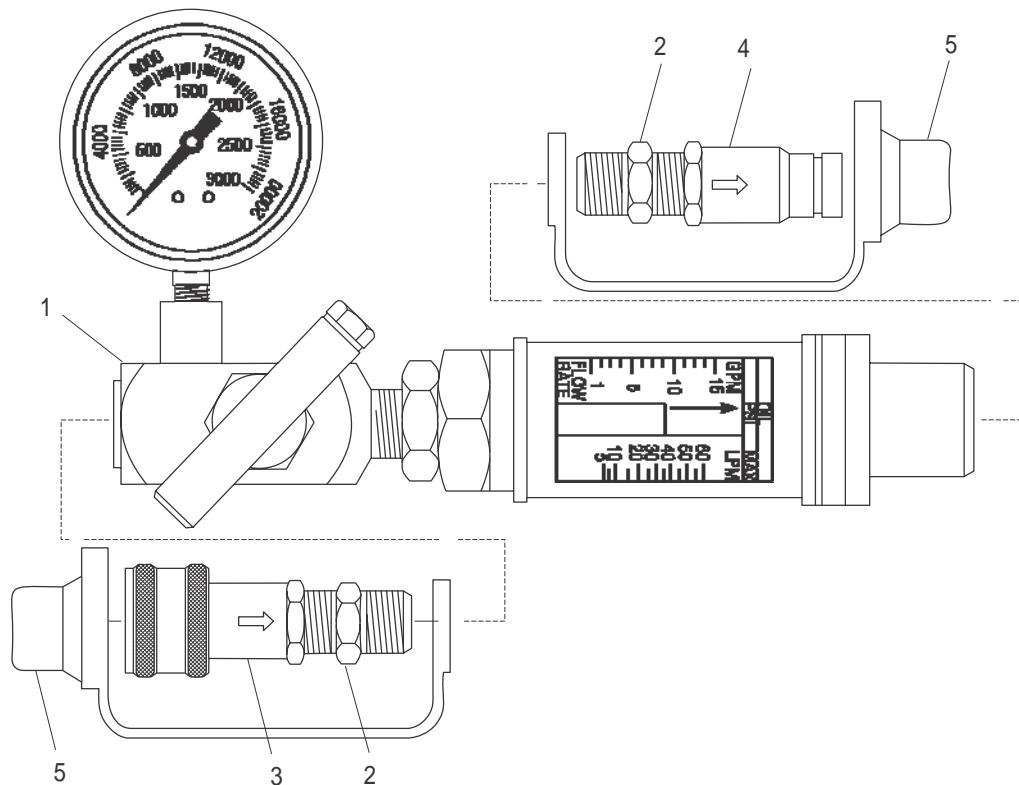

| 序号 | UPC 编号<br>78-3310- | 零件编号     | 描述   | 数量 |
|----|--------------------|----------|--|----|
|    | 40884              | 50408840 | 流量测试套件(包括1-5项) .....   | 1  |
| 1  |                    | 52000616 | 流量计和流量表, 1-10 gpm, 0-3,000 psi,<br>1/2 FNPT两端(Hedland #693015) ..... | 1  |
| 2  | 41351              | 50413513 | 转换接头, 1/2 MNPT x 1/2 MNPT .....                                      | 2  |
| 3  | 41778              | 50417781 | 内螺纹接头, 1/2 FNPT .....  | 1  |
| 4  | 41779              | 50417791 | 外螺纹接头, 1/2 FNPT .....  | 1  |
| 5  | 41834              | 50418341 | 防尘盖 .....  | 2  |

## 油管 and 油管套件

油管和油管套件的选型、安装与维护—SAE J1273  
1986

### SAE推荐方法

#### 1. 范围

油管（亦包括油管总成）有一定使用寿命，诸多因素会造成其寿命缩短。

本推荐方法作为指导，协助系统设计者及/或使用用户进行油管的选型、安装与维护。设计者与使用者必须系统查看每项应用，然后进行油管的选型、安装和维护，以实现应用需求。以下是一般指南，不一定是完整列表。



不正确的选型、安装或维护可能会导致过早出现故障、人身伤害或财产损失。

#### 2. 选型

以下是在对油管进行最后选型之前的一系列必须加以考虑的因素。

- 2.1 压力—确认系统压力之后，油管选型时必须让推荐最大操作压力等于或大于系统压力。波动压力大于最大操作压力会缩短油管寿命，液压设计者必须加以考虑。
- 2.2 抽气—用于抽气的油管必须能耐受系统负压。
- 2.3 温度—必须谨慎确保流体和环境温度（包括静态的和瞬态的）不得超过油管极限值。当流经热管附近时必须特别小心。
- 2.4 流体兼容性—油管选型必须确保油管、外胶层和管件与所用流体的兼容性。在针对气体应用的油管选型时必须加倍谨慎。

- 2.5 尺寸—通过承压流体进行的动力传送随压力和流速变化。组件尺寸必须足以将压力损失保持在最小值，避免热量产生或过大紊流造成的油管损坏。
- 2.6 路线选择—必须注意优选路线以最小化内在问题。
- 2.7 环境—必须注意确保油管和管件兼容或者不受所暴露的环境影响。环境条件例如紫外光、臭氧、盐水、化学品和空气污染物会导致性能恶化和早期故障，因此必须加以考虑。
- 2.8 机械负载—外部压力可能会显著减少油管寿命。必须加以考虑的机械负载包括过度挠曲、扭曲、压曲、拉伸或侧负载、弯曲半径、振动。转体型管件或接头的使用可能会要求确保油管内无扭曲。不常见应用可能要求在油管选型前进行特殊测试。
- 2.9 磨损—尽管油管设计有一定程度的抗磨损，但是必须注意保护油管不受过度磨损，过度磨损可能会导致油管外胶层的腐蚀、挂破和切断。露增强层会显著加速油管故障。
- 2.10 正确的终端接头—必须注意要确保基于按工业标准（如SAE J517d）进行试验落实的制造厂家的标准选择的油管和接头之间的正确兼容。
- 2.11 长度—确定正确的油管长度时，冲击吸收、管长随压力变化以及油管和机械公差也必须考虑。
- 2.12 规格与标准—当选择油管时，必须复核政府、行业和制造商的规格和推荐值，它们必须是可适用的。
- 2.13 油管清洁度—油管组件因清洁度级别而异。必须注意确保所选总成有足够级别适合应用的清洁度。
- 2.14 导电性—某些应用要求油管绝缘以防止导电。其他应用要求油管能充分导电以排除静电。油管和接头必须根据这些需求加以选择。

## 油管 and 油管套件（续）

### 3. 安装

选择正确的油管后，安装人员必须考虑以下因素。

- 3.1 安装前检查—安装前，必须仔细检查油管。必须检查所有组件的类型、尺寸和长度是否正确。另外，必须检查油管的清洁度、内径、堵塞物、气泡、松动的外胶层、或任何其它可见缺陷。
- 3.2 遵守制造商组装指南。
- 3.3 最小弯曲半径—小于最小弯曲半径进行安装会显著减少油管寿命。必须尤其注意在油管/管件接合处排除锐弯状况。
- 3.4 扭曲角和方向—安装油管时，机械组件的相对运动允许产生油管弯曲而不允许扭曲。
- 3.5 牢固—在许多应用中，必须对油管加以限制、保护或导引，防止出现不必要的挠曲、压力骤增和接触其他机械组件，从而造成损坏。必须注意确保这些限制不会产生额外的应力或磨损点。
- 3.6 正确的接口条件—正确的油管物理安装需要正确安装的接口连接，同时确保油管内无扭曲或扭矩。
- 3.7 避免外部损坏—确保拉伸负载、侧负载、扭接、扁平、潜在磨损、螺纹损坏，以及密封表面的损坏得到修正或消除之后，恰当的安装才算完成。
- 3.8 系统检查—安装完成后，必须消除所有滞留空气，将系统给压至最大系统压力，并检查是否功能恰当无泄漏。  
*注：测试时避免潜在危险区域。*

### 4. 维护

即使进行了正确选型和安装，若不执行持续维护方案，油管寿命仍可能显著减少。频率需由应用和潜在风险的严重程度而定。  
维护方案应至少包括以下内容。

- 4.1 油管存放—存放中的油管可能会受到温度、湿度、臭氧、阳光、油、溶剂、腐蚀液体和烟气、昆虫、啮齿动物和放射性物质的不利影响。存放区域应相对低温、避光、无灰尘、无潮气、不发霉。
- 4.2 目视检查—出现下列情况之一需更换油管：
  - a. 管件处或油管内泄露。（泄露液体有着火危险）。
  - b. 外胶层损坏、切断或磨损。（任何增强层露出）。
  - c. 油管出现扭接、压碎、压平或扭曲。
  - d. 油管硬化、僵直、热裂纹或烧焦。
  - e. 外胶层起泡、软降解或松动。
  - f. 管件裂开、损坏或严重腐蚀。
  - g. 管件在油管上滑动。
- 4.3 目视检查—以下各项必须视需要进行拧紧、维修或更换。
  - a. 出现泄露的接口。
  - b. 管夹、防护装置、屏蔽板。
  - c. 除去过多的脏物堆积。
  - d. 系统流体液位、流体类型、滞留空气。
- 4.4 功能测试—在最大操作压力下操作系统，检查可能有的异常且无泄露。  
*注：测试时避免潜在危险区域。*
- 4.5 更换间隔时间—专门的更换时间间隔须根据之前的使用寿命、政府或工业的建议，或各种故障可能导致意外停机、损坏或伤害危险的时间来考虑。

承蒙1990 SAE手册允许进行翻印。





美国                    800-435-0786        传真: 800-451-2632  
                              815-397-7070        传真: 815-397-1865  
加拿大                    800-435-0786        传真: 800-524-2853  
国际+1-815-397-7070 (以上为电话) 传真: +1-815-397-9247

地址: 4455 Boeing Drive • Rockford, IL 61109-2988 •USA•  
电话: 815-397-7070  
通过ISO 9001认证

[www.greenlee.com](http://www.greenlee.com)



# INSTRUCTION MANUAL

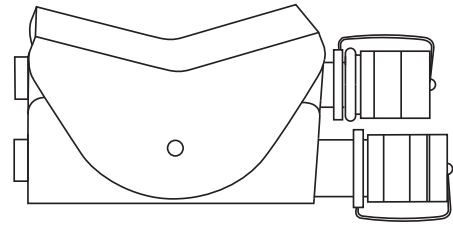
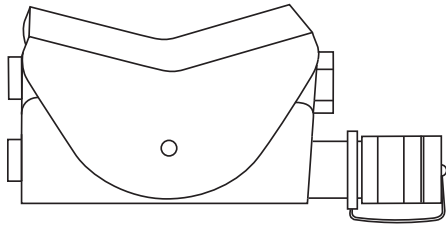

CE

## **PVA0021 and PVA0022 Hydraulic Control Valves**



**Read and understand** all of the instructions and safety information in this manual before operating or servicing this tool.

## Table of Contents

|  |       |
|--|-------|
| Description .....                          | 2     |
| Safety .....                               | 2     |
| Purpose of this Manual .....               | 2     |
| Important Safety Information .....         | 3–5   |
| Identification .....                       | 6     |
| Specifications .....                       | 6–7   |
| Hose Connections .....                     | 8     |
| Typical Setup .....                        | 8     |
| Operation .....                            | 9     |
| Maintenance .....                          | 10    |
| Troubleshooting .....                      | 11–12 |
| Disassembly .....                          | 13    |
| Inspection .....                           | 13    |
| Assembly .....                             | 14–15 |
| Illustration and Parts List .....          | 16–17 |
| Accessories .....                          | 18–20 |
| Hose and Hose Assemblies (SAE J1273) ..... | 21–22 |

### **⚠ WARNING**

Do not disconnect tool, hoses, or fittings while the tool is running or if the hydraulic fluid is hot. Hot hydraulic fluid could cause serious burns.

All specifications are nominal and may change as design improvements occur. Greenlee Tools, Inc. shall not be liable for damages resulting from misapplication or misuse of its products. Loctite and 242 are registered trademarks of Loctite Corporation.

## Description

The Greenlee Remote Control Valves are compact, lightweight, high-pressure valves rated for a maximum of 700 bar (10,000 psi) of hydraulic pressure. They are intended to provide control for hydraulic tools that operate on open-center hydraulic systems.

- PVA0021 is for single-acting tools and features a 3/8" coupler.
- PVA0022 is for double-acting tools and has 1/4" couplers.

These four-way valves have three operating positions: Advance, Neutral, and Retract. A special hold feature locks the tool in its stroke when the lever is in the neutral position.

To reduce operator fatigue, they feature an automatic spring-returned lever. This provides automatic shut-off and returns the valve to neutral when the hydraulic system's operating pressure is achieved, or when the tool is at the end of its stroke.

For operator safety, Greenlee remote control valves include a ground dump relief valve in the valve return circuit. This relief valve will automatically open if the return couplers are not connected properly. The ground dump relief pressure is listed under "Specifications".

In addition, PVA0022 has an internal relief valve that limits the tool retract pressure. This feature protects tools that cannot withstand a return-side pressure greater than 345 bar (5000 psi).

## Safety

Safety is essential in the use and maintenance of Greenlee tools and equipment. This instruction manual and any markings on the unit provide information for avoiding hazards and unsafe practices related to the use of this unit. Observe all of the safety information provided.

## Purpose of this Manual

This instruction manual is intended to familiarize all personnel with the safe operation, maintenance, and service procedures for the following Greenlee valves:

- PVA0021 (50429481)
- PVA0022 (50429491)

Keep this manual available to all personnel.

Replacement manuals are available upon request at no charge.

# **KEEP THIS MANUAL**

## IMPORTANT SAFETY INFORMATION

|   |  |
|---|--|
|                          | <p style="text-align: center;"><b>SAFETY<br/>ALERT<br/>SYMBOL</b></p> <p>This symbol is used to call your attention to hazards or unsafe practices which could result in an injury or property damage. The signal word, defined below, indicates the severity of the hazard. The message after the signal word provides information for preventing or avoiding the hazard.</p> |
| <b>⚠ DANGER</b>   |  |
| <p>Immediate hazards which, if not avoided, <b>WILL</b> result in severe injury or death.</p>             |  |
| <b>⚠ WARNING</b>  |  |
| <p>Hazards which, if not avoided, <b>COULD</b> result in severe injury or death.</p>                      |  |
| <b>⚠ CAUTION</b>  |  |
| <p>Hazards or unsafe practices which, if not avoided, <b>MAY</b> result in injury or property damage.</p> |  |

|   |  |
|---|--|
|  | <p style="text-align: center;"><b>⚠ WARNING</b></p> <p>Read and understand all of the instructions and safety information in this manual before operating or servicing this tool.</p> <p>Failure to observe this warning could result in severe injury or death.</p> |
|---|--|

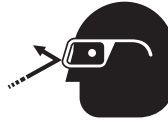
|   |   |
|---|---|
|  | <p style="text-align: center;"><b>⚠ WARNING</b></p> <p>Wear eye protection when operating or servicing this tool.</p> <p>Failure to wear eye protection could result in serious eye injury from flying debris or hydraulic oil.</p> |
|---|---|

|   |   |
|---|---|
|  | <p style="text-align: center;"><b>⚠ WARNING</b></p> <p>Electric shock hazard:</p> <p>This tool is not insulated. When using this unit near energized electrical lines, use only certified non-conductive hoses and proper personal protective equipment.</p> <p>Failure to observe this warning could result in severe injury or death.</p> |
|---|---|

|   |   |
|---|---|
|  | <p style="text-align: center;"><b>⚠ WARNING</b></p> <p>Skin injection hazard:</p> <ul style="list-style-type: none"> <li>• Do not use hands to check for leaks.</li> <li>• Do not hold hose or couplers while the hydraulic system is pressurized.</li> <li>• Depressurize the hydraulic system before servicing.</li> </ul> <p>Oil under pressure easily punctures skin causing serious injury, gangrene or death. If you are injured by escaping oil, seek medical attention immediately.</p> |
|---|---|

## **IMPORTANT SAFETY INFORMATION**

### **⚠ WARNING**

Use hoses, fittings, and other components rated for 700 bar (10,000 psi). An under-rated component may fail under pressure.

Failure to observe this warning could result in severe injury or death.

### **⚠ WARNING**

Do not disconnect valve, hoses, or fittings while the power source is running or if the hydraulic fluid is hot. Hot hydraulic fluid could cause serious burns.

### **⚠ WARNING**

Do not reverse hydraulic flow. Operation with hydraulic flow reversed can cause tool malfunction. Connect the pressure (supply) hose and tank (return) hose to the proper ports.

### **⚠ WARNING**

Do not change accessories, inspect, adjust or clean valve when it is connected to a power source. Accidental start-up can result in serious injury.

Failure to observe this warning could result in severe injury or death.

### **⚠ CAUTION**

Hydraulic oil can cause skin irritation.

- Handle the valve and hoses with care to prevent skin contact with hydraulic oil.
- In case of accidental skin contact with hydraulic oil, wash the affected area immediately to remove the oil.

Failure to observe these precautions may result in injury.

### **⚠ WARNING**



Valve and other components may be hot during and after operation. Allow to cool before handling, or handle with heat-resistant gloves.

Failure to observe this warning could result in severe injury.

### **⚠ WARNING**



Wear gloves when using this tool.

Failure to observe this warning could result in serious injury.

### **⚠ WARNING**

Do not exceed the following hydraulic power source maximums:

- Hydraulic flow: Refer to the product specifications. Do not exceed 5 l/min (1.32 gpm).
- Pressure relief setting: 138 bar (2000 psi)
- Back pressure: 13.8 bar (200 psi)

Failure to observe this warning could result in severe injury or death.

## **IMPORTANT SAFETY INFORMATION**

### **⚠ CAUTION**

- Inspect the hydraulic hoses and couplings every operating day. Repair or replace if leakage, cracking, wear or damage is evident. Damaged hoses or couplings can fail, resulting in injury or property damage.
- Make sure all bystanders are away from the work area when handling, starting, and operating the tool. Nearby personnel can be injured by flying debris or by flying parts in the event of a tool malfunction.

### **⚠ CAUTION**

Use the valve for manufacturer's intended purpose only. Use other than that which is instructed in this manual may result in injury or property damage.

Do not use this valve to operate a hydraulic jack. The valve is not intended for this use.

### **IMPORTANT**

Procedure for connecting or disconnecting hydraulic hoses, fittings, or components:

1. Set the PVA valve to the neutral position.
2. Move the flow lever on the hydraulic power source to the OFF position.
3. Stop the hydraulic power source.
4. Follow the sequence under "Hose Connections" to prevent pressure buildup. In case some pressure has built up, loosen hoses, fittings, or components slowly.

### **IMPORTANT**

Emergency stop procedure:

1. Release the lever.
2. Shut off the hydraulic power source.

*Note: Keep all decals clean and legible, and replace when necessary.*

*When disposing of any components (hydraulic hoses, hydraulic fluid, worn parts, etc.), do so in accordance with federal, state, and local laws or ordinances.*

## Identification

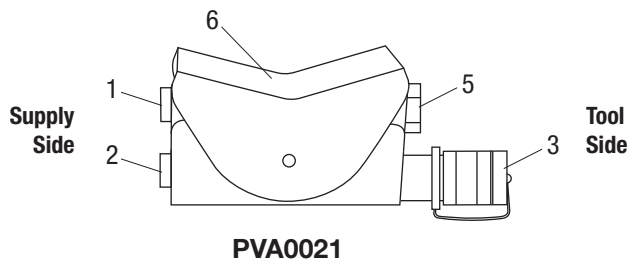

**PVA0021**

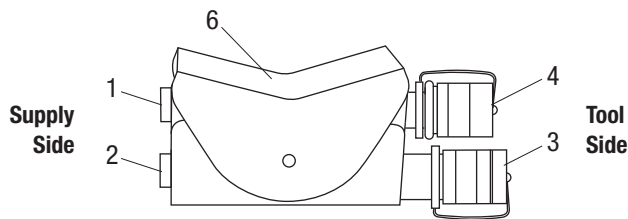

**PVA0022**

1. Tank Port
2. Pressure Port
3. Pressure Coupler
4. Return Coupler
5. Plug
6. Lever

## Specifications

### PVA0021 Hydraulic Control Valve

|                                    |                                      |
|------------------------------------|--------------------------------------|
| Type of Valve .....                | Single-acting                        |
| Type of Hydraulic System.....      | Open-center                          |
| Tool Connection .....              | 3/8–18 female quick coupler          |
| Power Source Connection            |                                      |
| Pressure .....                     | 1/4–18 NPT                           |
| Tank.....                          | 1/4–18 NPT                           |
| Ground Dump                        |                                      |
| Relief Valve Setting .....         | 207 to 276 bar<br>(3000 to 4000 psi) |
| Return Relief Valve Setting.....   | N/A                                  |
| Pressure Relief Valve Setting..... | 700 bar (10,000 psi)                 |
| Length .....                       | 231 mm (9.1")                        |
| Width .....                        | 45 mm (1.75")                        |
| Height.....                        | 83 mm (3.25")                        |
| Weight/Mass.....                   | 1.3 kg (2.75 lb)                     |

### PVA0022 Hydraulic Control Valve

|                                    |                                      |
|------------------------------------|--------------------------------------|
| Type of Valve .....                | Double-acting                        |
| Type of Hydraulic System.....      | Open-center                          |
| Tool Connection:                   |                                      |
| Pressure .....                     | 1/4–18 NPSM female coupler           |
| Return .....                       | 1/4–18 NPSM male coupler             |
| Power Source Connection            |                                      |
| Pressure .....                     | 1/4–18 NPT                           |
| Tank.....                          | 1/4–18 NPT                           |
| Ground Dump                        |                                      |
| Relief Valve Setting .....         | 207 to 276 bar<br>(3000 to 4000 psi) |
| Return Relief Valve Setting.....   | 345 bar (5000 psi)                   |
| Pressure Relief Valve Setting..... | 700 bar (10,000 psi)                 |
| Length .....                       | 191 mm (7.5")                        |
| Width .....                        | 45 mm (1.75")                        |
| Height.....                        | 83 mm (3.25")                        |
| Weight/Mass.....                   | 1.2 kg (2.5 lb)                      |

## Specifications (cont'd)

### Hydraulic Power Source

#### **⚠ WARNING**

Do not exceed the following hydraulic power source maximums:

- Hydraulic flow: Refer to the product specifications. Do not exceed 5 l/min (1.32 gpm).
- Pressure relief setting: 138 bar (2000 psi)
- Back pressure: 13.8 bar (200 psi)

Failure to observe this warning could result in severe injury or death.

1. Maximum hydraulic fluid temperature must not exceed 60 °C (140 °F). A sufficient oil cooling capacity is needed to limit the hydraulic fluid temperature.
2. Hydraulic flow must not exceed 5 l/min (1.32 gpm). Install a flow meter in the return line to measure to rate of hydraulic flow before using the tool.
3. Pressure relief valve setting must not exceed 138 bar (2000 psi) at your tool's maximum flow. Locate the pressure relief valve in the supply circuit to limit excessive hydraulic pressure to the tool.

### Recommended Hydraulic Fluids

Use any non-detergent, petroleum-based hydraulic fluid which meets the following specifications or HTMA specifications.

S.U.S. @

38 °C (100 °F)..... 140 to 225

99 °C (210 °F)..... 40 minimum

Flash Point..... 170 °C (340 °F) minimum

Pour Point..... -34 °C (-30 °F) minimum

Type of Hydraulic System..... Open-center  
 Pressure Relief Setting ..... 138 bar (2000 psi)  
 Back Pressure (maximum)\* ..... 13.8 bar (200 psi)  
 Filtration..... 10 Micron (nominal)

\* 13.8 bar (200 psi) is the maximum agreed standard back pressure for the HTMA (Hydraulic Tool Manufacturers Association). Greenlee tool will operate satisfactorily at this standard.

### Hydraulic Schematic

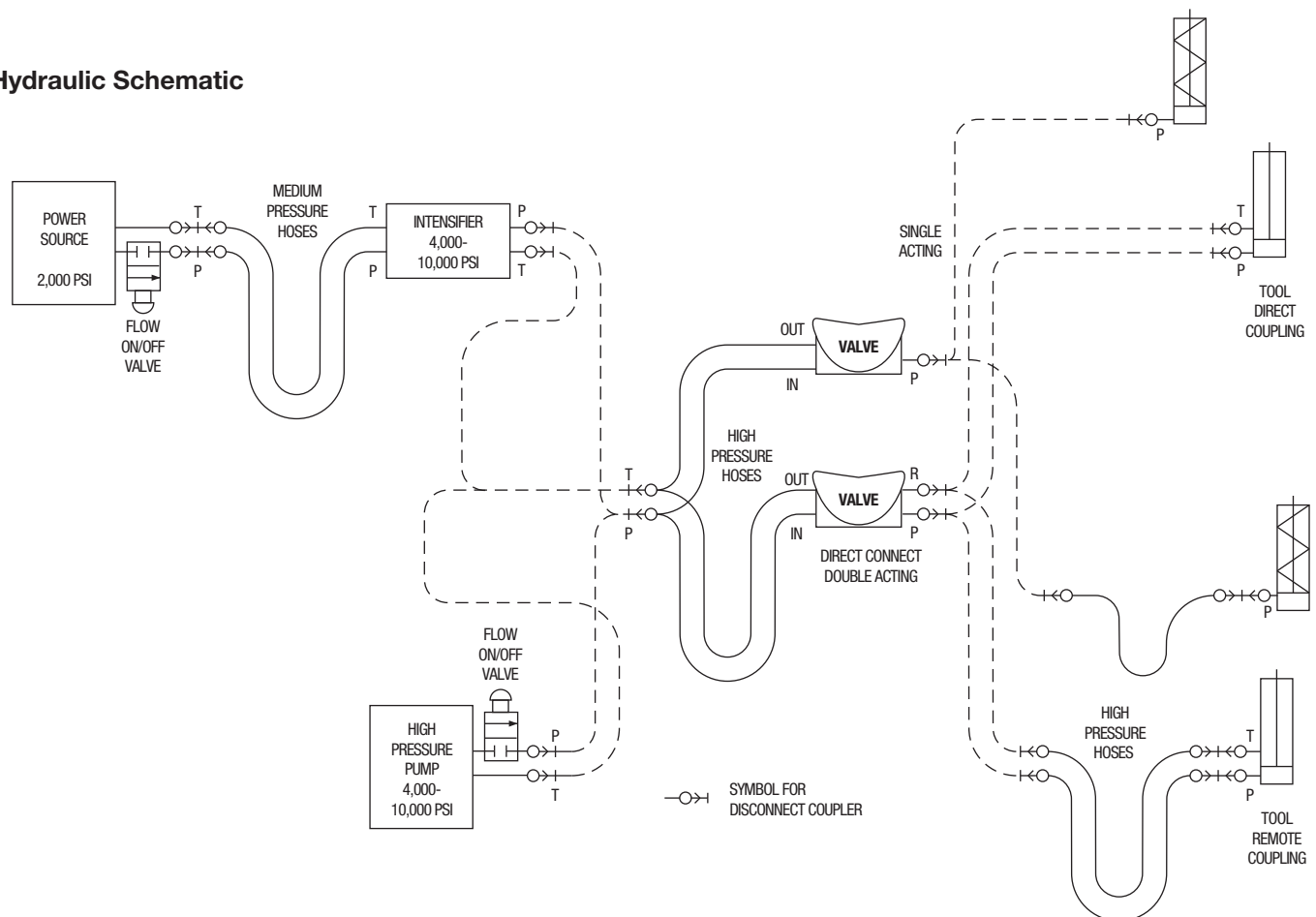

## Hose Connections

### Connecting Hoses

1. Move the flow lever on the power source to the OFF position.
2. Stop the hydraulic power source.
3. Connect the hoses in the order shown.

### Disconnecting Hoses

1. Move the flow lever on the power source to the OFF position.
2. Stop the hydraulic power source.
3. Disconnect the hoses in the order shown.
4. Install dust caps.

*Note: Return (tank) hose connection should always be connected before supply (pressure) hose connection to prevent pressure buildup inside the unit.*

## Typical Setup

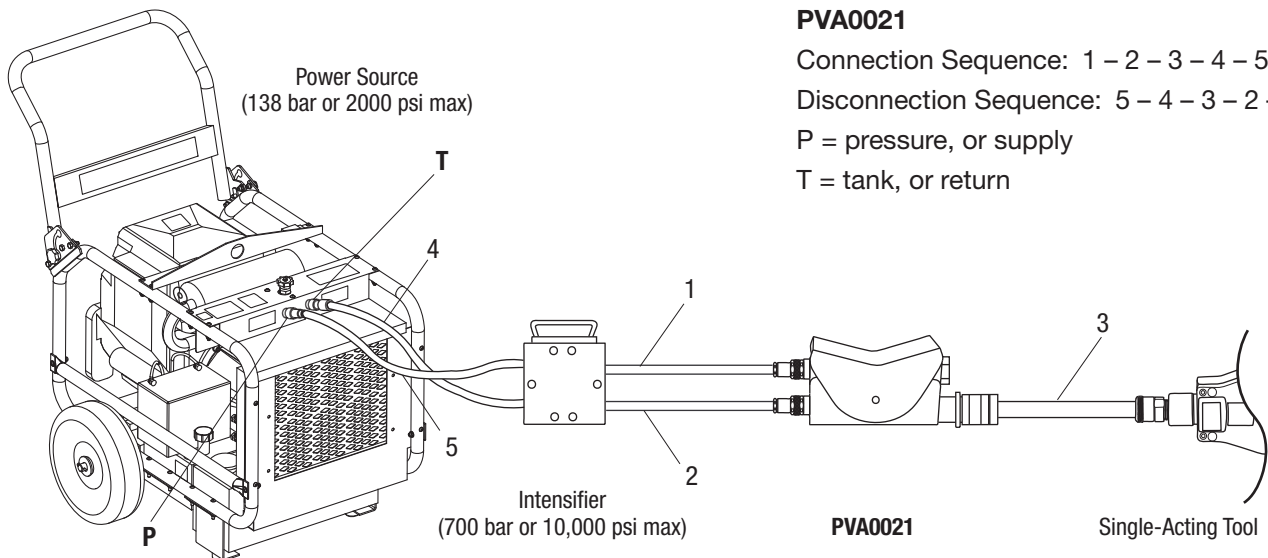

### PVA0021

Connection Sequence: 1 – 2 – 3 – 4 – 5

Disconnection Sequence: 5 – 4 – 3 – 2 – 1

P = pressure, or supply

T = tank, or return

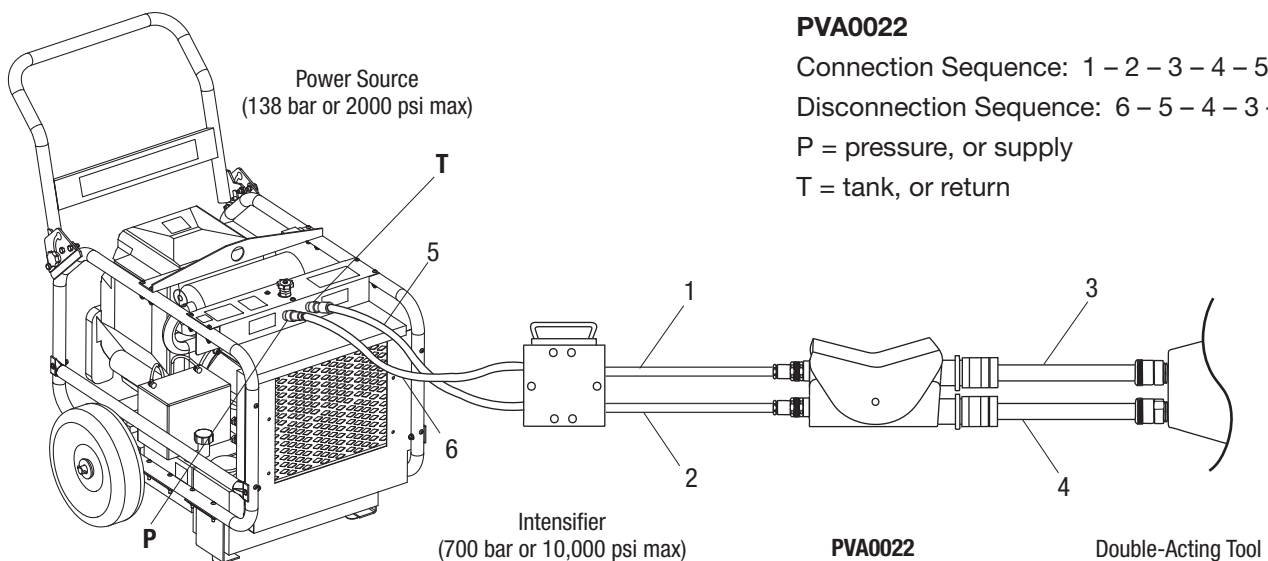

### PVA0022

Connection Sequence: 1 – 2 – 3 – 4 – 5 – 6

Disconnection Sequence: 6 – 5 – 4 – 3 – 2 – 1

P = pressure, or supply

T = tank, or return



**Operation**

|   |   |
|---|---|
|  | <b>⚠ WARNING</b>  |
|   | <p>Electric shock hazard:</p> <p>This tool is not insulated. When using this unit near energized electrical lines, use only certified non-conductive hoses and proper personal protective equipment.</p> <p>Failure to observe this warning could result in severe injury or death.</p> |

|   |   |
|---|---|
|  | <b>⚠ WARNING</b>  |
|   | <p>Valve and other components may be hot during and after operation. Allow to cool before handling, or handle with heat-resistant gloves.</p> <p>Failure to observe this warning could result in severe injury.</p> |

|  |   |
|--|---|
|  | <b>⚠ WARNING</b>  |
|  | <p>Skin injection hazard:</p> <ul style="list-style-type: none"> <li>• Do not use hands to check for leaks.</li> <li>• Do not hold hose or couplers while the hydraulic system is pressurized.</li> <li>• Depressurize the hydraulic system before servicing.</li> </ul> <p>Oil under pressure easily punctures skin causing serious injury, gangrene or death. If you are injured by escaping oil, seek medical attention immediately.</p> |

|   |   |
|---|---|
|  | <b>⚠ WARNING</b>  |
|   | <p>Wear eye protection when operating or servicing this tool.</p> <p>Failure to wear eye protection could result in serious eye injury from flying debris or hydraulic oil.</p> |

|   |
|---|
| <b>⚠ WARNING</b>  |
| <p>Use hoses, fittings, and other components rated for 700 bar (10,000 psi). An under-rated component may fail under pressure.</p> <p>Failure to observe this warning could result in severe injury or death.</p> |

*Note: Maintain proper footing and balance while using the tool. Do not over-reach. Unsuitable footing and balance may not allow counteracting normal or unexpected movement of the tool.*

1. Start the power source.

*Note: Allow the power source to run for a few minutes to warm the hydraulic fluid.*

2. Position the tool in the appropriate location or position.
3. To start the tool, press the lever to ADVANCE.

*Notes:*

- *When the hydraulic pressure reaches 207 bar to 276 bar (3000 psi to 4000 psi), you may release the lever and it will stay in the ADVANCE position. The tool will continue to advance until the intensifier reaches 700 bar (10,000 psi).*
- *You may stop the tool at any time by pressing the lever to NEUTRAL.*

4. To retract the tool, press the lever to RETRACT.
5. When the tool is not in use, stop the power source to reduce heat and wear on tool components.

## Maintenance

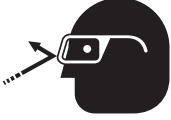
|   |   |
|---|---|
|  | <b>⚠ WARNING</b>  |
|   | <p>Wear eye protection when operating or servicing this tool.</p> <p>Failure to wear eye protection could result in serious eye injury from flying debris or hydraulic oil.</p> |

|   |
|---|
| <b>⚠ WARNING</b>  |
| <p>Do not change accessories, inspect, or clean tool when it is connected to a power source. Accidental start-up can result in serious injury.</p> <p>Failure to observe this warning could result in severe injury or death.</p> |

*Note: Keep all decals clean and legible, and replace when necessary.*

*When disposing of any components (hydraulic hoses, hydraulic fluid, worn parts, etc.), do so in accordance with federal, state, and local laws or ordinances.*

Use this maintenance schedule to maximize the tool's service life.

### Daily

1. Wipe all tool surfaces clean.
2. Inspect the hydraulic hoses and fittings for signs of leaks, cracks, wear or damage. Replace if necessary.
3. Install dust caps when the tool is disconnected.

### Monthly

1. Perform a thorough inspection of the hydraulic hoses and fittings as described in "Hose and Hose Assemblies" at the end of this manual or in publication 99930323, SAE J1273.
2. Check the pressure to the tool by installing an in-line pressure gauge, rated for 700 bar (10,000 psi), between the valve and the tool.

### Annually

If required by your organization, have the tool inspected by a Greenlee Authorized Service Center.

## Troubleshooting

### Isolating the Tool or Hoses

Before troubleshooting, determine whether the problem is in the tool, the hoses, or the power source. Substitute a tool or high-pressure hoses known to be in good working order to isolate the item that is not operating. If the problem is in the tool, see the troubleshooting table in the manual provided with the tool. If the problem is in the hoses, replace them.

### Isolating the Valve and Hydraulic Power Source

1. Stop the hydraulic power source.
2. Disconnect the tank (return) hose from the tank (return) port of the pump. Place the hose so that any fluid will run into a waste container.
3. Set the PVA valve to the neutral position.
4. Start the power source.
  - If hydraulic fluid flows from the disconnected return hose, proceed to Step 5.

- If hydraulic fluid does not flow from the disconnected return hose, verify that the pump is working properly. If the pump is working properly, the faulty component is likely to be the hoses or the PVA valve. Substitute high-pressure hoses known to be in good working order. If the problem is in the PVA valve, see the troubleshooting table in this manual, or send the PVA valve to a Greenlee Authorized Service Center.
5. Set the valve to the advance position.
    - If hydraulic fluid flows from the disconnected return hose, the faulty component is likely to be the PVA valve. See the troubleshooting table in this manual, or send the PVA valve to a Greenlee Authorized Service Center.
    - If hydraulic fluid does not flow from the disconnected return hose, the fault is likely to be in the pump or intensifier. See the corresponding manuals for the appropriate troubleshooting procedures.

| Problem   | Probable Cause  | Probable Remedy  |
|---|---|--|
| The PVA's lever sticks or binds.                                  | Dirt, gummy deposits, or other contamination under the lever.                 | Clean the area under the lever.  |
|   | Valve spring is sticking, binding, or broken.                                 | Clean or replace the spring.   |
| Hydraulic fluid flows out from the ground dump relief valve port. | The tank (return) coupler is not properly connected.                          | Disconnect the coupler and reconnect it properly.  |
|   | One of the tank (return) couplers on one of the system components is damaged. | Replace the damaged coupler.   |
|   | The remote control valve is connected improperly.                             | Connect the pressure (supply) hose and tank (return) hose to the proper ports.   |
|   | The ground dump relief valve is clogged.                                      | Clean or replace the ground dump relief valve components. Assemble the valve and adjust the settings.                      |
| The tool does not advance.  | The remote control valve seal is lodged in the seal positioning hole.         | Disassemble the valve and reposition the seal. Assemble the valve and adjust the settings.                                 |
|   | The remote control valve is leaking hydraulic fluid.                          | Disassemble the valve and replace the O-rings and backup rings. Assemble the valve and adjust the settings.                |
|   | The return relief valve is clogged.   | Disassemble the valve and clean or replace the return relief valve components. Assemble the valve and adjust the settings. |

## Troubleshooting (cont'd)

| Problem   | Probable Cause   | Probable Remedy   |
|---|--|---|
| The tool does not retract.  | The remote control valve seal is lodged in the seal positioning hole.  | Disassemble the valve and reposition the seal. Assemble the valve and adjust the settings.                      |
| The lever does not return to neutral after reaching the operating pressure.   | Dirt, gummy deposits, or other contamination under the lever.  | Clean the area under the lever.   |
|   | Some lever components are binding or damaged.  | Disassemble the lever and clean or replace the faulty components.   |
|   | The hydraulic oil is cold.   | Allow the oil to warm to the operating temperature. Actuate the tool intermittently to reduce the warming time. |
|   | The return spring is binding or broken.  | Disassemble the lever and clean or replace the faulty components.   |
|   | The control lever is not adjusted correctly; the lever stops are not aligned correctly.                                  | Disassemble the lever and stops. Adjust and align.  |
| The tool advances, builds pressure, and retracts, but does not build enough pressure to complete the operation (crimp the cable, etc.). | The pressure coupler connection between the valve and the tool is not complete.  | Tighten the coupler connection.   |
|   | The remote control valve builds pressure on both sides of the control lever, but there is no hydraulic flow to the tool. | The valve disk unit assembly was installed incorrectly.   |
| The pressure coupler connection between the tool and the valve is not complete.   |  | Tighten the coupler connection.   |

## Disassembly

Complete disassembly of the tool is not recommended. If a complete overhaul is necessary, return the tool to your nearest Greenlee Authorized Service Center.

The disassembly procedure is divided into sections of the tool. Disassemble only the section(s) necessary to complete the repair.

Disassemble the tool on a flat, clean surface. Take care not to lose or damage any parts that may fall free during disassembly.

### PVA0021: Plug, Coupler, and Adapter

1. Remove the adapter (25) and copper washer (31) from the block (21).
2. Use an O-ring tool to remove the internal O-ring (27) from the female coupler (26).
3. Remove the plug (24) and copper washer (31).

### PVA0022: Couplers

1. Remove the couplers (29, 30) and copper washers (31) from the block (21).
2. Use an O-ring tool to remove the internal O-ring (32) from the female coupler (30).

### Lever and Springs

1. Remove the two screws (3) from the lever (1). Spread the sides of the lever and remove it from the block (21).
2. Use a pair of pliers to hold the treadle stop (15). Remove the screw (14) and compression spring (16).
3. Repeat Step 2 for the other stop, screw, and spring.

### Valve Cap

*Note: The notch in the shaft of the valve disk unit (8) keeps the valve disk unit aligned to the block (21); mark the valve disk unit for proper alignment during assembly.*

1. Use a spanner wrench to unscrew the valve cap (4).  
*Note: Do not allow the valve disk to rotate while removing the cap.*
2. Remove the valve cap (4), thrust race (6) and thrust bearing (7).
3. Remove the O-ring (5) from the valve cap.

### Valve Disk

*Note: The holes in the back of the valve disk must be aligned correctly for proper assembly. Mark the end of the valve disk for proper alignment.*

1. Remove the valve disk unit (8) from the block (21).
2. Remove the two O-rings (9) from the valve disk assembly.

*Note: Do not disassemble the valve disk components that are pressed together.*

### Shear Seals

*Note: Make a note of the location of each shear seal in the block before removal.*

1. Remove the three shear seals (10) and compression springs (13).
2. Remove the O-ring (12) and backup ring (11) from each seal.

### PVA0021: Port Plug

1. Remove the two hollow set screws (33) from the block.
2. Remove the port plug (17) from the block.

### PVA0022: Return Relief Valve

1. Unscrew the two hollow set screws (33).
2. Remove the compression spring (20) and valve pin (19).

### Ground Dump Relief Valve

1. Unscrew the two hollow set screws (18).
2. Remove the compression spring (20) and valve pin (19).

## Inspection

Clean all parts with an appropriate cleaning solution and dry them thoroughly. Inspect each component as described in this section. Replace any component that shows wear or damage.

1. **Thrust bearing (7):** Insert the thrust bearing (7), thrust race (6) and valve disk unit (8) into the valve cap (4). Hold the cap in one hand and spin the valve disk with your other hand. The motion should be smooth with no rough spots. If it is not smooth, replace the bearing and race.
2. **Valve block (21), valve disk unit (8), and valve cap (4):** Inspect mating surfaces, bores, oil passageways, etc. for grooves or nicks.
3. **Shear seals (10) and compression springs (13):** Install the compression springs and shear seals into their ports. Push each shear seal in, then release. The shear seal should return by spring force without sticking or binding in the valve block.
4. **Valve pin (19) and PVA block:** The valve pin must seal completely. If it does not, dress the seat with a sharp drill point and re-seat.
5. **Thrust rings:** Replace any thrust ring that is out-of-round.
6. Inspect all other disassembled components for cracks, grooves or nicks.

## Assembly

### IMPORTANT

These hydraulic control valves are high-pressure components, with a maximum capacity of 700 bar (10,000 psi). Follow the assembly and adjustment instructions carefully so that the valve will operate properly.

Refer to the Illustration and Parts List for correct orientation and placement of parts.

Replace any O-rings and copper washers on parts that have been disassembled. Apply hydraulic fluid or O-ring lubricant to all O-rings and all metal surfaces which they must slide over. When installing an O-ring which must slide over sharp surfaces, use a rolling motion and be careful not to damage the O-ring.

Wherever the assembly results in metal-to-metal contact, coat the surfaces with hydraulic fluid or O-ring lubricant.

Some steps of the assembly procedure require a removable type of thread sealing and locking compound, such as Loctite® 242® or equivalent. Follow the manufacturer's instructions for curing.

#### Shear Seals

*Note: Install each shear seal in its original bore.*

1. Assemble one backup ring (11) and one O-ring (12) to each seal. Lubricate the O-rings.
2. Install three compression springs (13) and three shear seals (10) to the valve block (21).

#### Valve Disk

1. Assemble two O-rings (9) to the valve disk unit (8).
2. Assemble the valve disk unit to the valve block (21). Use the mark made during disassembly for proper alignment.

#### Valve Cap

1. Assemble the O-ring (5) to the valve cap (4).
2. Assemble the thrust race (6) and thrust bearing (7) to the valve cap (4).
3. While holding the valve disk unit (8) in place with a pair of pliers, thread the valve cap assembly onto the shaft of the valve disk unit. Use a spanner wrench to tighten the valve cap.

*Note: If the valve disk unit rotates during this step, the unit will not function properly.*

#### Lever and Springs

*Note: Step 1 requires a thread locking compound for hardware that will be adjusted in Step 7. Prepare the tools and components so you can complete the procedure before the compound hardens.*

1. Apply a removable type of thread sealing and locking compound, such as Loctite® 222 or equivalent, to the socket head screws (14). Follow the manufacturer's instructions for curing.
2. Install one socket head cap screw (14) into the valve block (21). Assemble one compression spring (16) and treadle stop (15). Tighten the socket head cap screw (14).
3. Repeat Step 2 for the other stop, screw and spring.
4. Install the valve lever (1) to the valve block (21), and secure with two screws (3).
5. Install the rubber boot (23). Apply a bead of glue to the perimeter of the boot.
6. Set the valve lever (1) to the neutral position. Back out the two screws (14) evenly until both treadle stops (15) lightly contact the valve lever.

#### PVA0021: Plug, Coupler, and Adapter

*Note: If the adapter (25) and female coupler (26) were disassembled, assemble them with a thread sealant that is compatible with hydraulic fluid. Do not, however, use a thread sealant to assemble the adapter to the valve block.*

1. Use an O-ring tool to install the internal O-ring (27) into the coupler (26).
2. Install the adapter (25) with a new copper washer (31) to the block (21). Torque to 27 Nm to 32 Nm (20 ft-lb to 24 ft-lb).
3. Install the plug (24) with a new copper washer (31) to the block (21). Torque to 27 Nm to 32 Nm (20 ft-lb to 24 ft-lb).

#### PVA0022: Couplers

*Note: This procedure requires the use of either a compatible tool or an assembly gauge (Greenlee number 50407711, purchased separately).*

1. Use an O-ring tool to install the internal O-ring (32) into the female coupler (30).
2. Thread the couplers (29, 30) with new copper washers (31) to the block (21). Do not tighten the couplers.
3. Use the compatible tool or an assembly gauge, as follows:
  - Connect the tool to the unit, as shown.

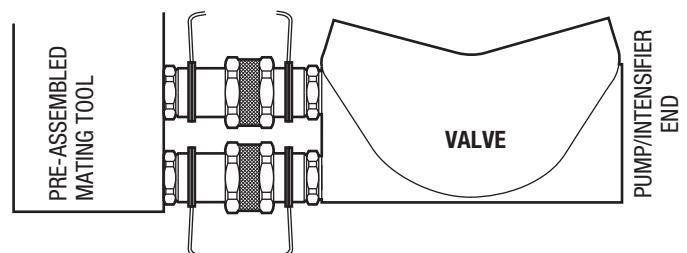

## Assembly (cont'd)

- Secure the assembly gauge in a vise. Mate the unit to the assembly gauge so that the male coupler is in the hole and the female coupler is over the pin.

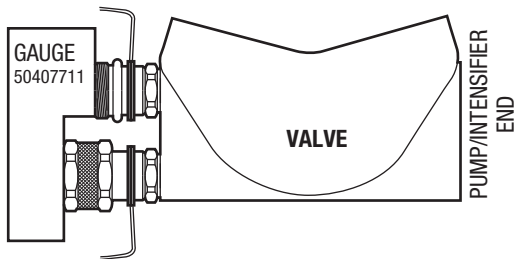

4. Tighten the couplers—evenly, alternating after each turn—until both couplers are tightened securely. Torque to 27 Nm to 32 Nm (20 ft-lb to 24 ft-lb).

### PVA0021: Port Plug

1. Install the port plug (17) into port T.
2. Install and tighten the two hollow set screws (33).

### PVA0022: Return Relief Valve

1. Install the valve pin (19) into port R. Lightly tap the end of the valve pin to form the seat.
2. Install the compression spring (20).
3. Apply a removable type of thread sealing and locking compound, such as Loctite® 222 or equivalent, to one hollow set screw (33). Follow the manufacturer's instructions for curing.
4. Use a high-pressure hydraulic hose and an in-line pressure gauge to connect the power source to the supply pressure port.
5. Position the unit so that the supply end is pointing toward a shield, such as a piece of sheet metal, with a pan to catch any escaping hydraulic fluid. Place the valve lever in the neutral position.
6. Start the hydraulic power source. Gradually increase the hydraulic pressure until oil sprays out through the hollow set screws (33). Note the pressure reading on the gauge when oil begins to spray out.
7. Shut off the power source and depressurize the hydraulic system.
8. If the hydraulic pressure was within the specified relief pressure range of 345 bar to 372 bar (5000 psi to 5400 psi) when the oil began to spray out, proceed to Step 10. Otherwise, proceed to Step 9.
9. To adjust the setting:
  - Turn the set screw clockwise to increase the relief pressure setting.
  - Turn the set screw counterclockwise to decrease the relief pressure setting.

10. Repeat Steps 6–9 until the setting is within the specified range. Install the second hollow set screw (33) and tighten it against the first hollow set screw.
11. Repeat Step 6 to ensure that the setting was not disturbed in Step 10.

### Ground Dump Relief Valve

1. Install the valve pin (19) into the center passage on the valve block (21). With a pin punch, lightly tap the stem of the valve pin (19). Insert the compression spring (20).
2. Apply a removable type of thread sealing and locking compound, such as Loctite® 222 or equivalent, to one hollow set screw (33). Follow the manufacturer's instructions for curing.
3. Use a high-pressure hydraulic hose and an in-line pressure gauge to connect the power source to the supply pressure port.
4. Disconnect the return line from the PVA valve, leaving the coupler in place to plug the port.
5. Position the unit so that the supply end is pointing toward a shield, such as a piece of sheet metal, with a pan to catch any escaping hydraulic fluid. Place the valve lever in the neutral position.
6. Start the hydraulic power source. Leaving the treadle in the neutral position, gradually increase the hydraulic pressure until oil sprays out through the hollow set screws (33). Note the pressure reading on the gauge when oil begins to spray out.
7. Shut off the power source and depressurize the hydraulic system.
8. If the hydraulic pressure was within the specified relief pressure range of 207 bar to 276 bar (3000 psi to 4000 psi) when the oil began to spray out, proceed to Step 10. Otherwise, proceed to Step 9.
9. To adjust the setting:
  - Turn the set screw clockwise to increase the relief pressure setting.
  - Turn the set screw counterclockwise to decrease the relief pressure setting.
10. Repeat Steps 6–9 until the setting is within the specified range. Install the second hollow set screw (33) and tighten it against the first hollow set screw.
11. Repeat Step 6 to ensure that the setting was not disturbed in Step 10.





## Parts List

| Key | UPC No.<br>78-3310- | Part No. | Description  | Qty     |         |
|-----|---------------------|----------|--|---------|---------|
|     |                     |          |  | PVA0021 | PVA0022 |
| 1   | 43459               | 50434594 | Valve lever with warning decal (next item).....      | 1       | 1       |
|     | 43460               | 50434608 | Decal, warning (not shown).....                      | 1       | 1       |
| 2   | 43461               | 50434616 | Decal, identification.....                           | 1       | 0       |
| 2   | 43462               | 50434624 | Decal, identification.....                           | 0       | 1       |
| 3   | 48703               | 50487035 | Screw, #8-32 x .250 slotted truss head.....          | 2       | 2       |
| 4   | 43465               | 50434659 | Valve, cap.....                                      | 1       | 1       |
| 5*  | 43262               | 50432621 | O-ring, 1.75 x 1.875 x .062-70.....                  | 1       | 1       |
| 6   | 42017               | 50420173 | Race, thrust, 1.002 x 1.552 x .032.....              | 1       | 1       |
| 7   | 43467               | 50434675 | Bearing, thrust, 1.005 x 1.547 x .078.....           | 1       | 1       |
| 8   | 43468               | 50434683 | Disk unit, valve.....                                | 1       | 1       |
| 9   | 43469               | 50434691 | O-ring, .250 x .375 x .062-70.....                   | 2       | 2       |
| 10  | 43470               | 50434705 | Seal, shear.....                                     | 3       | 3       |
| 11* | 43049               | 50430491 | Backup ring, single turn, .140 x .246 x .048.....    | 3       | 3       |
| 12* | 41844               | 50418440 | O-ring, .125 x .250 x .062-70.....                   | 3       | 3       |
| 13* | 43471               | 50434713 | Spring, compression.....                             | 3       | 3       |
| 14  | 43472               | 50434721 | Screw, #10-32 x 1.75 socket head.....                | 2       | 2       |
| 15  | 43473               | 50434730 | Stop, treadle.....                                   | 2       | 2       |
| 16  | 43474               | 50434748 | Spring, compression.....                             | 2       | 2       |
| 17  | 43475               | 50434756 | Port plug.....                                       | 1       | 0       |
| 18  | 43476               | 50434764 | Screw, set, 3/8-24 x .187, hollow socket.....        | 2       | 2       |
| 19  | 30146               | 50301462 | Pin, valve, .305 x .870.....                         | 1       | 2       |
| 20  | 48234               | 50482343 | Spring, compression, .190 x .318 x 1.088.....        | 1       | 2       |
| 21  | 43477               | 50434772 | Block, PVA valve.....                                | 1       | 1       |
| 22  | 41830               | 50418301 | Dust cap.....  | 1       | 0       |
| 23  | 43478               | 50434780 | Boot, rubber.....                                    | 1       | 1       |
| 24  | 40764               | 50407641 | Plug, 1/4-18 NPSM.....                               | 1       | 0       |
| 25  | 40748               | 50407481 | Adapter, 3/8-18 NPTF to 1/4-18 NPSM F/M.....         | 1       | 0       |
| 26  | 41877               | 50418771 | Female coupler.....                                  | 1       | 0       |
| 27* | 42030               | 50420304 | O-ring, .750 x 1.00 x .125-90.....                   | 1       | 0       |
| 28  | 41834               | 50418341 | Dust cap.....  | 0       | 2       |
| 29  | 40647               | 50406471 | Male coupler, 1/4-18 NPSM.....                       | 0       | 1       |
| 30  | 40652               | 50406522 | Female coupler, 1/4-18 NPSM.....                     | 0       | 1       |
| 31  | 40646               | 50406461 | Washer, flat, .514 x .030, copper.....               | 2       | 2       |
| 32* | 41842               | 50418421 | O-ring.....  | 0       | 1       |
| 33  | 54643               | 90546431 | Screw, set, 7/16-20 hollow socket.....               | 2       | 2       |
| *   | 43479               | 50434799 | Packing kit (includes items marked with an asterisk) |         |         |

## Accessories

### 700 bar (10,000 psi) High-Pressure Certified Nonconductive Hose

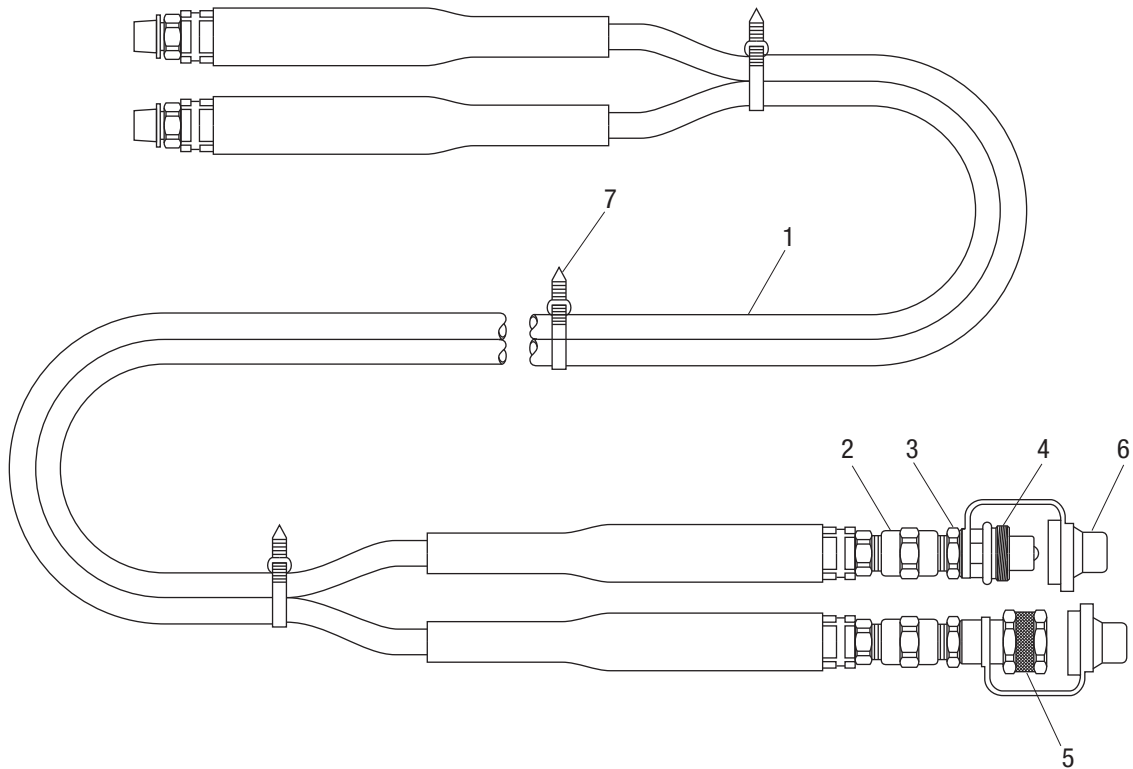

| UPC No.<br>Key 78-3310- | Part No. | Description | Qty |
|-------------------------|----------|-------------|-----|
|-------------------------|----------|-------------|-----|

#### Complete Hose Assemblies Rated at 700 bar (10,000 psi)

|       |          |                                 |   |
|-------|----------|---------------------------------|---|
| 41107 | 50411074 | 6 ft (includes items 1-7).....  | 1 |
| 41108 | 50411083 | 10 ft (includes items 1-7)..... | 1 |

#### Hoses Rated at 700 bar (10,000 psi)

|   |       |          |                                  |   |
|---|-------|----------|----------------------------------|---|
| 1 | 41795 | 50417951 | 6 ft, 1/4 MNPT x 1/4 MNPT .....  | 1 |
| 1 | 41796 | 50417961 | 10 ft, 1/4 MNPT x 1/4 MNPT ..... | 1 |

| UPC No.<br>Key 78-3310- | Part No. | Description | Qty |
|-------------------------|----------|-------------|-----|
|-------------------------|----------|-------------|-----|

#### Couplers and Fittings

|   |       |          |                                      |   |
|---|-------|----------|--------------------------------------|---|
| 2 | 41401 | 50414014 | Coupler, 1/4 FNPT x 1/4 FNPT .....   | 2 |
| 3 | 41344 | 50413442 | Adapter, 1/4 MNPT x 1/4 MNPT .....   | 1 |
| 4 | 41811 | 50418112 | Male coupler, 1/4 FNPT .....         | 1 |
| 5 | 42096 | 50420961 | Female coupler, 1/4 MPNT .....       | 1 |
|   | 41842 | 50418421 | O-ring, 5/8 x 13/16 x 3/32-90D ..... | 1 |
| 6 | 41834 | 50418341 | Dust cap .....                       | 2 |
| 7 | 41587 | 50415870 | Ty-Rap .....                         | 3 |

## Accessories (cont'd)

### 700 bar (10,000 psi) High-Pressure Couplers

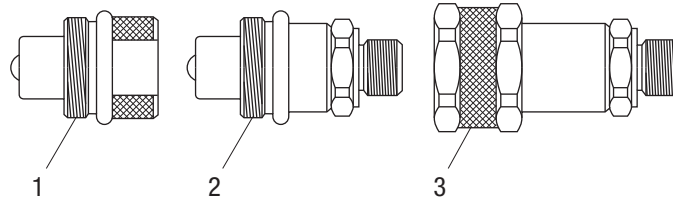

|   | UPC No.  | Part No.   | Description   | Qty |
|---|----------|--|---|-----|
| 1 | 41811    | 50418112   | Male coupler, 1/4 FNPT.....                                   | 1   |
|   | 41941    | 50419411   | Male coupler, 3/8 FNPT.....                                   | 1   |
| 2 | 40647    | 50406471   | Male coupler, 1/4 MNPS.....                                   | 1   |
|   | 40646    | 50406461   | Washer, copper.....   | 1   |
| 3 | 42096    | 50420961   | Female coupler, 1/4 MNPT.....                                 | 1   |
|   | 41842    | 50418421   | O-ring, 5/8 x 13/16 x 3/32-90.....                            | 1   |
|   | 40652    | 50406522   | Female coupler, 1/4 MNPS.....                                 | 1   |
|   | 41842    | 50418421   | O-ring, 5/8 x 13/16 x 3/32-90.....                            | 1   |
|   | 40646    | 50406461   | Washer, copper.....   | 1   |
|   | 41877    | 50418771   | Female coupler, 3/8 MNPT<br>(Pioneer or Bruning).....         | 1   |
|   | 42030    | 50420304   | O-ring, .734 x 1.012 x .139-90<br>(Pioneer coupler only)..... | 1   |
|   | 41372    | 50413722   | O-ring, .737 x .943 x .103-70<br>(Bruning coupler only).....  | 1   |
|   | 52000678 | Backup ring, .759 x .929 x .085<br>(Bruning coupler only)..... | 1   |     |

## Accessories (cont'd)

### Flow Test Kit for Testing Low-Pressure Systems

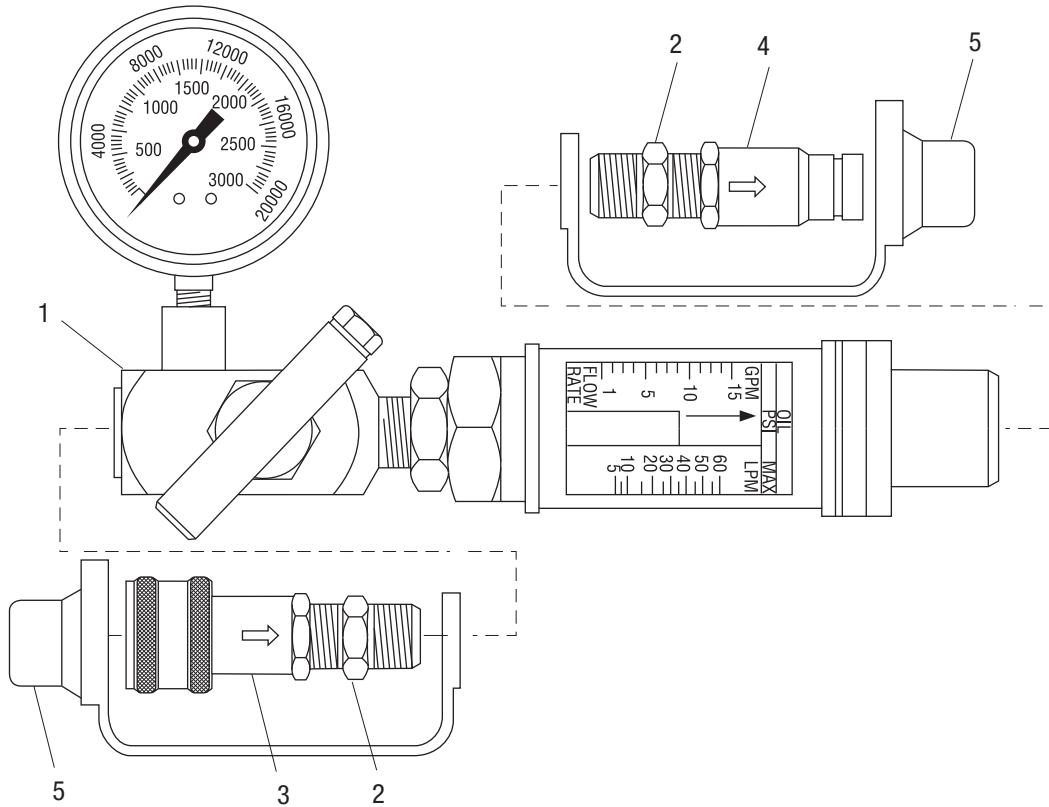

| UPC No.<br>Key 78-3310- | Part No.       | Description   | Qty |
|-------------------------|----------------|---|-----|
| 40884                   | 50408840       | Flow test kit (includes items 1–5) .....  | 1   |
| 1                       | 52000616       | Flow meter and gauge, 1–10 gpm, 0–3,000 psi,<br>1/2 FNPT both ends (Hedland #693015)..... | 1   |
| 2                       | 41351 50413513 | Adapter, 1/2 MNPT x 1/2 MNPT.....   | 2   |
| 3                       | 41778 50417781 | Female coupler, 1/2 FNPT.....   | 1   |
| 4                       | 41779 50417791 | Male coupler, 1/2 FNPT.....   | 1   |
| 5                       | 41834 50418341 | Dust cap.....   | 2   |

## HOSE AND HOSE ASSEMBLIES

### SELECTION, INSTALLATION AND MAINTENANCE OF HOSE AND HOSE ASSEMBLIES —SAE J1273 1986

#### SAE Recommended Practice

##### 1. Scope

Hose (also includes hose assemblies) has a finite life and there are a number of factors which will reduce its life.

This recommended practice is intended as a guide to assist system designers and/or users in the selection, installation, and maintenance of hose. The designers and users must make a systematic review of each application and then select, install, and maintain the hose to fulfill the requirements of the application. The following are general guidelines and are not necessarily a complete list.

### **WARNING**

Improper selection, installation, or maintenance may result in premature failures, bodily injury, or property damage.

##### 2. Selection

The following is a list of factors which must be considered before final hose selection can be made.

- 2.1 Pressure – After determining the system pressure, hose selection must be made so that the recommended maximum operating pressure is equal to or greater than the system pressure. Surge pressures higher than the maximum operating pressure will shorten hose life and must be taken into account by the hydraulic designer.
- 2.2 Suction – Hoses used for suction applications must be selected to insure the hose will withstand the negative pressure of the system.
- 2.3 Temperature – Care must be taken to insure that fluid and ambient temperatures, both static and transient, do not exceed the limitations of the hose. Special care must be taken when routing near hot manifolds.
- 2.4 Fluid Compatibility – Hose selection must assure compatibility of the hose tube, cover, and fittings with fluid used. Additional caution must be observed in hose selection for gaseous applications.
- 2.5 Size – Transmission of power by means of pressurized fluid varies with pressure and rate of flow. The size of the components must be adequate to keep pressure losses to a minimum and avoid damage to the hose due to heat generation or excessive turbulence.
- 2.6 Routing – Attention must be given to optimum routing to minimize inherent problems.
- 2.7 Environment – Care must be taken to insure that the hose and fittings are either compatible with or protected from the environment to which they are exposed. Environmental conditions such as ultra-violet light, ozone, salt water, chemicals, and air pollutants can cause degradation and premature failure and, therefore, must be considered.
- 2.8 Mechanical Loads – External forces can significantly reduce hose life. Mechanical loads which must be considered include excessive flexing, twist, kinking, tensile or side loads, bend radius, and vibration. Use of swivel type fittings or adapters may be required to insure no twist is put in the hose. Unusual applications may require special testing prior to hose selection.
- 2.9 Abrasion – While a hose is designed with a reasonable level of abrasion resistance, care must be taken to protect the hose from excessive abrasion which can result in erosion, snagging and cutting of the hose cover. Exposure of the reinforcement will significantly accelerate hose failure.
- 2.10 Proper End Fitting – Care must be taken to insure proper compatibility exists between the hose and coupling selected based on the manufacturer's recommendations substantiated by testing to industry standards such as SAE J517d.
- 2.11 Length – When establishing proper hose length, motion absorption, hose length changes due to pressure, as well as hose and machine tolerances must be considered.
- 2.12 Specifications and Standards – When selecting hose, government, industry, and manufacturer's specifications and recommendations must be reviewed and applicable.
- 2.13 Hose Cleanliness – Hose components vary in cleanliness levels. Care must be taken to insure that the assemblies selected have an adequate level of cleanliness for the application.
- 2.14 Electrical Conductivity – Certain applications require that the hose be non-conductive to prevent electrical current flow. Other applications require the hose to be sufficiently conductive to drain off static electricity. Hose and fittings must be chosen with these needs in mind.

## HOSE AND HOSE ASSEMBLIES (cont'd)

### 3. Installation

After selection of proper hose, the following factors must be considered by the installer.

- 3.1 Pre-Installation Inspection – Prior to installation, a careful examination of the hose must be performed. All components must be checked for correct style, size, and length. In addition, the hose must be examined for cleanliness, I.D. obstructions, blisters, loose cover, or any other visual defects.
- 3.2 Follow Manufacturers' Assembly Instructions.
- 3.3 Minimum Bend Radius – Installation at less than minimum bend radius may significantly reduce hose life. Particular attention must be given to preclude sharp bending at the hose/fitting juncture.
- 3.4 Twist Angle and Orientation – Hose installations must be such that relative motion of machine components produces bending of the hose rather than twisting.
- 3.5 Securement – In many applications, it may be necessary to restrain, protect, or guide the hose to protect it from damage by unnecessary flexing, pressure surges, and contact with other mechanical components. Care must be taken to insure such restraints do not produce additional stress or wear points.
- 3.6 Proper Condition of Ports – Proper physical installation of the hose requires a correctly installed port connection while insuring that no twist or torque is put into the hose.
- 3.7 Avoid External Damage – Proper installation is not complete without insuring tensile loads, side loads, kinking, flattening, potential abrasion, thread damage, or damage to sealing surfaces are corrected or eliminated.
- 3.8 System Check Out – After completing the installation, all air entrapment must be eliminated and the system pressurized to the maximum system pressure and checked for proper function and freedom from leaks.

*Note: Avoid potential hazardous area while testing.*

### 4. Maintenance

Even with proper selection and installation, hose life may be significantly reduced without a continuing maintenance program. Frequency should be determined by the severity of the application and risk potential.

A maintenance program should include the following as a minimum.

- 4.1 Hose Storage – Hose products in storage can be affected adversely by temperature, humidity, ozone, sunlight, oils, solvents, corrosive liquids and fumes, insects, rodents and radioactive material. Storage areas should be relatively cool and dark, and free of dust, dirt, dampness and mildew.
- 4.2 Visual Inspection – Any of the following conditions requires replacement of the hose:
  - a. Leaks at fitting or in hose.  
(Leaking fluid is a fire hazard).
  - b. Damaged, cut or abraded cover.  
(Any reinforcement exposed).
  - c. Kinked, crushed, flattened or twisted hose.
  - d. Hard, stiff, heat cracked or charred hose.
  - e. Blistered, soft degraded or loose cover.
  - f. Cracked, damaged, or badly corroded fittings.
  - g. Fitting Slippage on hose.
- 4.3 Visual Inspection – The following items must be tightened, repaired, or replaced as required:
  - a. Leaking port conditions.
  - b. Clamps, guards, shields.
  - c. Remove excessive dirt buildup.
  - d. System fluid level, fluid type, and any air entrapment.
- 4.4 Functional Test – Operate the system at maximum operating pressure and check for possible malfunctions and freedom from leaks.  
*Note: Avoid potential hazardous areas while testing.*
- 4.5 Replacement Intervals – Specific replacement intervals must be considered based on previous service life, government or industry recommendations, or when failures could result in unacceptable down time, damage, or injury risk.

Reprinted with permission from the 1990 SAE Handbook.





|               |                 |                      |
|---------------|-----------------|----------------------|
| USA           | 800-435-0786    | Fax: 800-451-2632    |
|               | 815-397-7070    | Fax: 815-397-1865    |
| Canada        | 800-435-0786    | Fax: 800-524-2853    |
| International | +1-815-397-7070 | Fax: +1-815-397-9247 |

4455 Boeing Drive • Rockford, IL 61109-2988 • USA • 815-397-7070  
An ISO 9001 Company • Greenlee Tools, Inc.

[www.greenlee.com](http://www.greenlee.com)