

H.V.L.P. GRAVITY FEED SPRAY GUN

Stock Number M707

OWNERS MANUAL

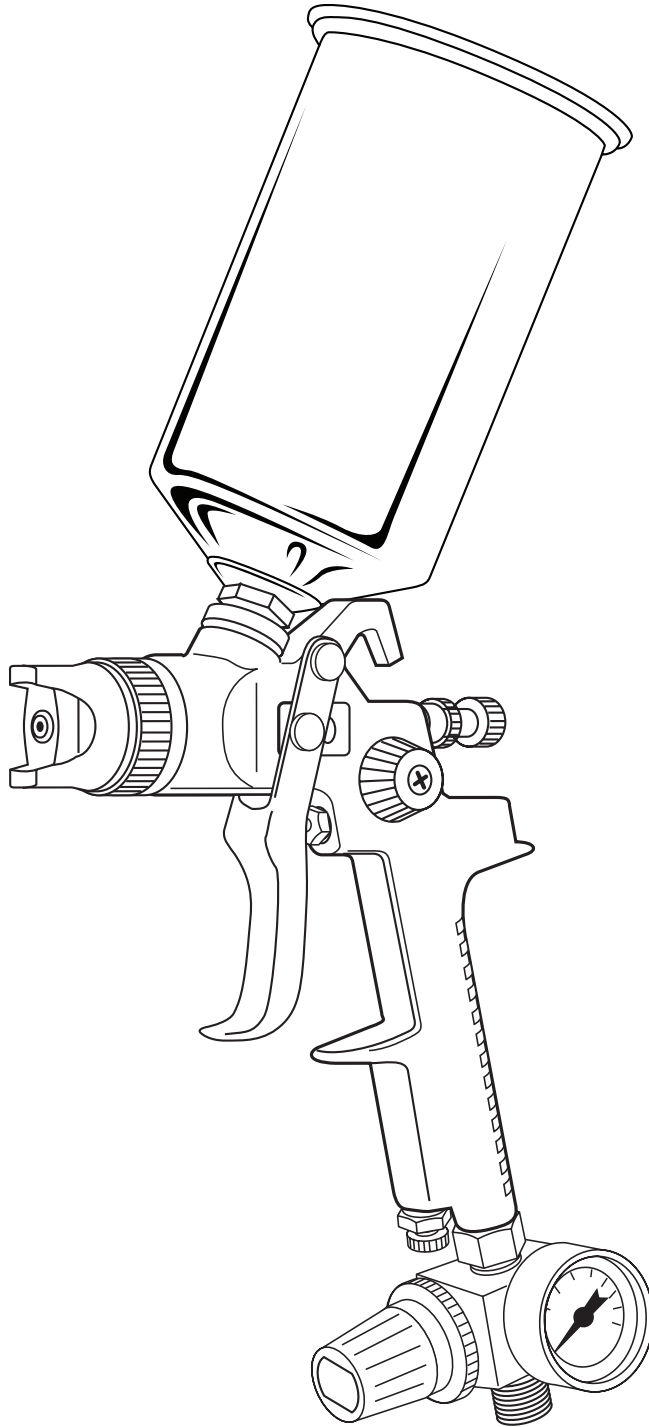

Performance Tool®

PT
Performance Tool®

Please read these instructions carefully and retain them for future use.

On occasion, after printing of our literature is completed, our manufacturers may make changes and/or modifications to merchandise which will not be reflected in this manual. Although we strive to maintain complete and accurate information, it is possible in some instances, that the product may differ slightly from printed specifications. Illustrations are intended for reference only. Actual merchandise may vary. Wilmar is not responsible for typographical errors.

SPECIFICATIONS

Air Pressure:.....	15 - 45 P.S.I.	Avg. Air Consumption (CFM):	7-9
Spray pattern:	3-7 in.	Fluid Inlet (NPS):	3/8 in.
Spray Head & Needle:	1.3, 1.5 & 1.7 MM	Air Inlet (NPS):.....	1/4 in.
Cup capacity:	1000 ml	Hose Size (ID):.....	3/8 in.

Specifications are subject to change without notice

IMPORTANT SAFETY INFORMATION

WARNING!

READ, UNDERSTAND AND FOLLOW ALL INSTRUCTIONS AND WARNINGS BEFORE OPERATING THIS TOOL. FAILURE TO DO SO MAY RESULT IN PERSONAL INJURY AND/OR PROPERTY DAMAGE AND WILL VOID WARRANTY.

1. Keep work area clean. Cluttered areas invite injuries.
2. Observe work area conditions. Do not use machines or power tools in damp or wet locations. Don't expose to rain. Keep work area well lighted. Do not use electrically powered tools in the presence of flammable gases or liquids. **Always keep work area free from obstructions and well ventilated.**
3. Keep children away. Children must never be allowed in the work area. Do not let them handle machines, tools, hoses or extension cords.
4. Store idle equipment. When not in use, tools must be stored in a dry location to inhibit rust. Always lock up tools and keep out of reach of children and other untrained persons. Switch off all unused electrical tools when stored. Tools are dangerous in the hands of untrained users.
5. **WARNING: All persons in the work area must always wear approved eye and ear protection and approved breathing apparatus when this spray gun is in operation.**
6. Work Safe. Do not wear loose clothing or jewelry that could become caught by moving parts, causing injury. Operate tool a safe distance from yourself and others in the work area. Keep proper footing and balance at all times. Do not reach over or across running machines, hoses, etc.
7. Stay alert. Watch what you are doing, use common sense. Be sure all personnel are clear of the direction of the spray gun. Do not operate any tool when you are tired.
8. Do not operate any tool if under the influence of alcohol or drugs. Read warning labels on prescriptions to determine if your judgment or reflexes are impaired while taking drugs. If there is any doubt, do not operate any tool.
9. Never aim spray gun at anyone. Do not spray near sparks, open flame, lit cigarettes, pilot lights, space heaters or any other potential ignition source. **DO NOT SMOKE IN WORK AREA.**
10. Follow air source manufacturers directions for connection of regulators, filters, and other accessories to air source. Do not install quick couplers directly on tool as they put unnecessary strain on the air inlet threads possibly causing them to wear out prematurely. Instead, install them on a short length of air hose attached to the tool.
11. Follow manufacturers instructions and safety information to ensure safe handling and proper use of paints, lacquers, thinners, base coats, etc. Do not use latex or other heavy paints. They are not recommended for this spray gun.
12. Always disconnect spray gun from air source before disassembly.
13. **Warning!** Solvents 1,1,1-Trichloroethane and Methylene Chloride (Dichloromethane - sometimes called Methylchloride) can chemically react with the Aluminum used in most spray equipment creating an explosion hazard. Read the label or data sheet from the material you intend to spray. NEVER use any material containing these solvents. If unsure as to the composition of your material, check with your supplier. Do not use acids for cleaning.
14. Check for damaged parts. Before using any tool, any part that appears damaged should be carefully checked to determine that it will operate properly and perform its intended function. Check for alignment and binding of moving parts; any broken parts or mounting fixtures; and any other condition that may affect proper operation. Any part that is damaged should be properly repaired or replaced by a qualified technician.
15. Maintenance. For your safety, maintenance should be performed regularly by a qualified technician using original PERFORMANCE TOOLS® replacement parts. Failure to do so can lead to accidents for the operator. Use of any other parts will void the warranty. Only use accessories intended for use with this tool. Approved accessories are available from Performance Tool®. Use only accessories that are recommended by the manufacturer for your model. Accessories that may be suitable for one tool may become hazardous when used on another tool.

WARNING: This product and its packaging contain a chemical known to the State of California to cause cancer, birth defects, or other reproductive harm.

WARNING: The warnings, cautions, and instructions discussed in this instruction manual cannot cover all possible conditions and situations that may occur. It must be understood by the operator that common sense and caution are factors which cannot be built into this product, but must be supplied by the operator. Read and understand all of the instructions provided in the instruction manual of this product, as well as, any other tool (s) used with this product.

CARE & MAINTENANCE

Warning! Clean gun before and after each use.

To protect the precision machined internal parts and fittings in this gun from corrosion during shipping, some oils or other corrosion resistant agents may have been applied. It is important to remove any such residue before attempting to use the gun. To clean, place a small amount of appropriate thinner into paint cup and spray through gun while pulling and releasing trigger repeatedly. Wipe exterior of gun, nozzles and paint cup. In some cases, if the gun becomes clogged, disassemble completely and soak all parts in thinner. After soaking, use wire and cleaning brush to clear small internal passages. Check and clean paint

cup filter. Replace if worn.

A clean air source is imperative to ensure peak performance. The use of an in-line air filter is highly recommended to keep any contaminants from entering the spray gun. Inspect all fittings and hardware to ensure proper seating. Be sure air line fittings are tight with no leaks. Replace any worn parts as necessary.

Check needle and nozzles for nicks, scratches or burrs. Any such conditions will seriously impair performance. Replace as necessary.

OPERATION

Step 1: Inlet Air Pressure Regulation

Assemble components of spray gun and connect to clean air source as described above. Clean air source is imperative to ensure peak performance. The use of an in-line air filter is highly recommended to keep any contaminants from entering the spray gun. Set inlet air pressure to between 20 and 30 P.S.I. to begin adjustments.

(This is a good operating inlet pressure suitable for most applications, however, depending on materials being sprayed and other external factors such as temperature, humidity, etc., you may need to come back to this step and increase or decrease pressure as needed after attempting adjustments in step 2.)

Inlet pressure is adjusted by turning the Pressure Regulator Control Knob. Knob must first be pulled out to unlock.

Turning knob clockwise increases pressure, turning knob counter-clockwise decreases pressure. Once desired pressure is reached, push the knob back in to lock the adjustment.

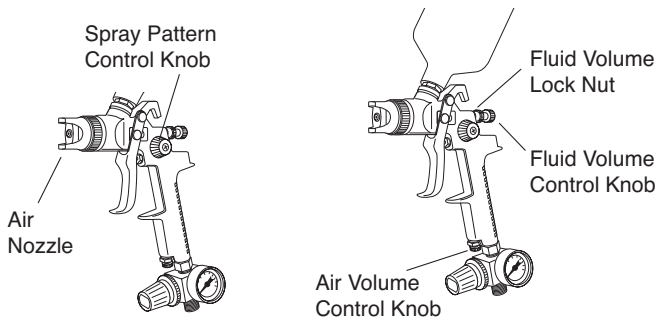
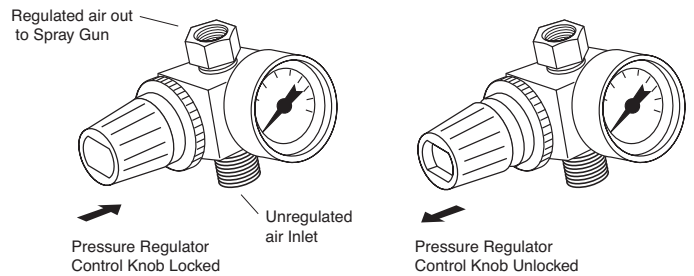

Step 2: Air and Fluid Volume Controls

These two controls are used in conjunction with each other to accurately adjust air/fluid (Paint) ratio and will vary for different paints. Changing one control Fluid Volume affects the other so alternating back and forth between them to fine tune your adjustment will yield optimum results.

Air Volume Control - Air volume is adjusted by turning the Air Fluid Volume Control Knob. Turning knob in reduces volume, turning knob out Control Knob increases volume.

Fluid Volume Control - Fluid volume is adjusted by turning the Fluid Volume Control Knob. Turning knob in decreases volume, turning knob out increases volume. Once a satisfactory volume is set, you can lock the adjustment by turning the lock nut in tight.

Step 3: Spray Pattern Controls

Pattern Shape - The shape of the spray can be adjusted from a round pattern to a flat pattern by turning the Pattern Control Knob. Turning knob in rounds the pattern, turning knob out flattens the pattern.

Pattern Orientation - A flat or semi-round spray pattern

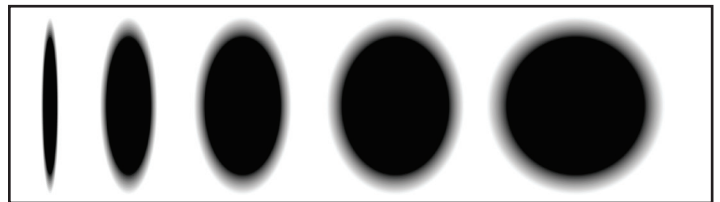

can be adjusted to any angle from horizontal to vertical by turning the Air Nozzle. Pattern is perpendicular to "ears" on nozzle. That is, when the ears are horizontal, the spray pattern will be vertical and when the ears are vertical the spray pattern will be horizontal.

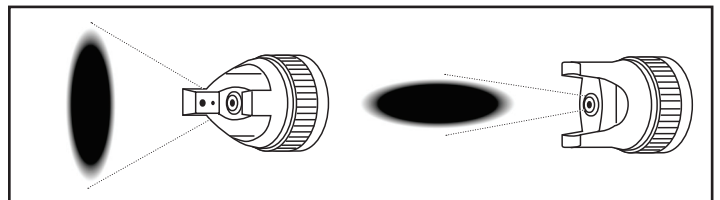

REPLACEMENT PARTS LIST

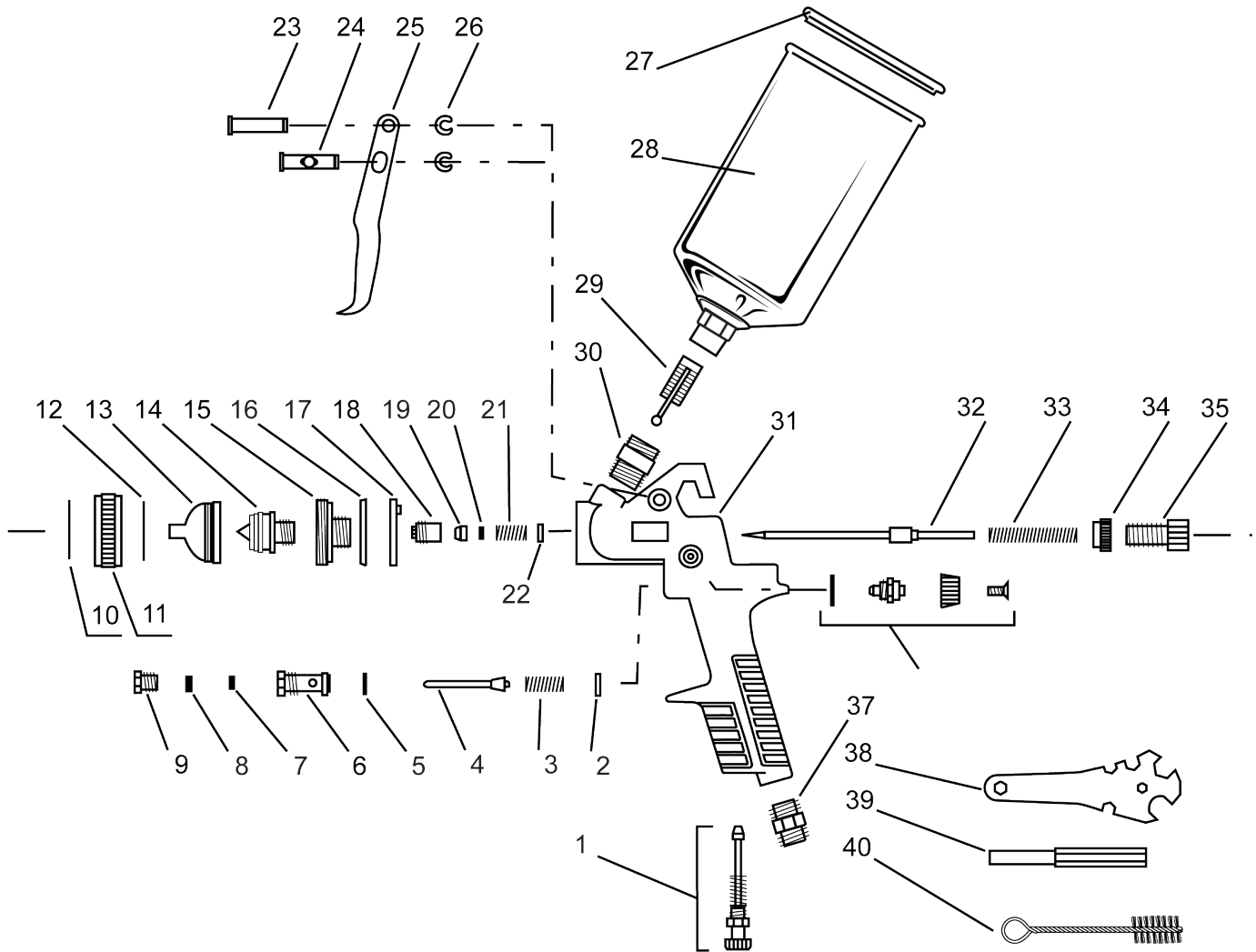

REPLACEMENT PARTS LIST

#	Description	Qty.	#	Description	Qty.
1.	Air Adjustment Valve (6.5 x 1.9 mm)	1	11.	Air Cap Locking Ring	1
2.	Gasket	1	12.	Air Cap Washer	1
3.	Air Valve Spring	1	13.	Air Cap	1
4.	Air Valve Piston Shaft	1	14.	Fluid Nozzle	1
5.	O-Ring (10.5 x 5.2 x 2.5 mm)	1	15.	Air Manifold	1
6.	Air Valve Seat	1	16.	Tapered Washer (34.5 x 32.5 x 1.6 mm)	1
7.	O-Ring (6.5 x 1.9 mm)	1	17.	Air Manifold Spacer	1
8.	Pliable Packing Washer	1	18.	Retention Screw	1
9.	Air Valve Packing Nut	1	19.	Paint Needle Washer	3
10.	Air Cap Retention Ring	1	20.	Sealing Washer	1

REPLACEMENT PARTS LIST

#	Description	Qty.	#	Description	Qty.
21.	Locking Spring	1	32.	Fluid Needle	1
22.	Gasket (9 x 3.3 x 2 mm)	1	33.	Fluid Needle Spring	1
23.	Trigger Pin - Pivot	1	34.	Fluid Adjustment Locking Ring	1
24.	Trigger Pin - Fluid Needle	1	35.	Fluid Adjustment Knob	1
25.	Trigger	1	36.	Pattern Adjustment Valve	1
26.	Retaining Ring	2		(10 x 1.5, 9 x 1.9 mm)	
27.	Lid	1	37.	Air Inlet Fitting	1
28.	Cup	1	38.	Gun Wrench	1
29.	Fluid Filter	1	39.	Internal/External Hex Wrench	1
30.	Fluid Inlet Fitting	1	40.	Brush	1
31.	Gun Body	1			

Call Customer service for replacement parts: 1-800-497-0552

TROUBLESHOOTING

Your spray gun was constructed with quality materials and workmanship and will give you many years of trouble free use when cared for as described in the "Care and Maintenance" section on page 3. However, as with any

mechanical device, periodic adjustments are necessary to maintain a peak level of performance. Should your spray gun be displaying any of the following symptoms, the simple procedures shown below will correct the problem.

WARNING - Disconnect spray gun from air source before making adjustments

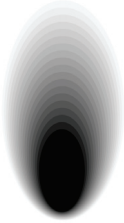
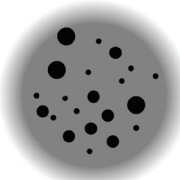
Problem:	Probable Cause:	Solution:
	Half-Moon Shaped Pattern This is usually caused by clogged air holes on the Air Nozzle ears.	Carefully clean out holes with wire after soaking in thinner.
	Irregular or Offset Pattern This can be caused by 1. A dirty or damaged Needle tip or Fluid Nozzle 2. Clogged atomization holes on Air Nozzle around the center	1. Clean or replace Needle or Fluid Nozzle. 2. Clean Air Nozzle
	Spitting 1. Too little material in cup 2. Loose Fluid Nozzle 3. Damaged Needle Packing 4. Dirty or damaged Needle & Nozzle Set.	1. Refill cup 2. Tighten Nozzle 3. Replace Packing 4. Clean or replace parts
	Material in cup bubbles or "Boils" 1. Loose, clogged or damaged Fluid Nozzle 2. Loose, clogged or damaged Air Nozzle	1. Clean, tighten or replace 2. Clean, tighten or replace

NOTE:

Problems listed above with more than one solution may have a combination of causes. Please be sure that all solutions listed for each problem have been checked to eliminate possibility of further trouble. Sometimes solutions may need to be repeated for best results.

LIMITED WARRANTY

PERFORMANCE TOOL® extends only the following warranties, and only to original retail purchasers. These warranties give specific legal rights. Except where prohibited by local law, the law of the State of Washington governs all warranties and all exclusions and limitations of warranties and remedies. There may be other rights which vary from state to state.

PERFORMANCE TOOL® warrants the product to be free from defects in materials and workmanship under normal use and service. A defective product may be returned for a free replacement within 90 days from the date of purchase, provided that product is returned to place of purchase immediately after discovery of defect. After 90 days and up to one year from date of purchase, PERFORMANCE TOOL® will replace at no charge any parts which our examination shall disclose to be defective and under warranty. These warranties shall be valid only when a sales receipt showing the date of purchase accompanies the defective product or defective part (s) being returned. For part (s) after 90 days, please remit your request, postage prepaid to:

PERFORMANCE TOOL, P.O. Box 88259 Tukwila, WA 98138

These warranties exclude blades, bits, punches, dies, bulbs, fuses, hoses, and other consumables which must be replaced under normal use and service. These warranties shall not apply to any product or part which is used for a purpose for which it is not designed, or which has been repaired or altered in any way so as to affect adversely its performance or reliability, nor shall these warranties apply to any product or part which has been subject to misuse, neglect, accident or wear and tear incident to normal use and service.

PERFORMANCE TOOL® does not authorize any other person to make any warranty or to assume any liability in connection with its products.

Except for warranties of title and the limited express warranties set forth above, PERFORMANCE TOOL® makes no express or implied warranties of any kind with respect to its products. In particular, PERFORMANCE TOOL® makes no implied warranty of merchantability and no implied warranty of fitness for any particular purpose, except that for goods purchased primarily for personal, family or household use and not for commercial or business use, PERFORMANCE TOOL® makes an implied warranty of merchantability (and, if otherwise applicable, an implied warranty of fitness for a particular purpose), but only for the particular qualities or characteristics, and for the duration, expressly warranted above.

The laws on limitation of implied warranties may differ from state to state, so the above limitations may not apply in all cases.

PERFORMANCE TOOL® shall not be liable for consequential, incidental or special damages resulting from or in any manner related to any product, or to the design, use, or any inability to use the product. The sole and exclusive remedy for a defective product or part shall be the repair, or replacement thereof as provided above. The laws on limitation of remedies or on consequential, incidental or special damages may vary from state to state, so the above limitations may not apply in all cases.