

SIDES

BOTTOM

Material:malleable casting,Finish:Zinc plated

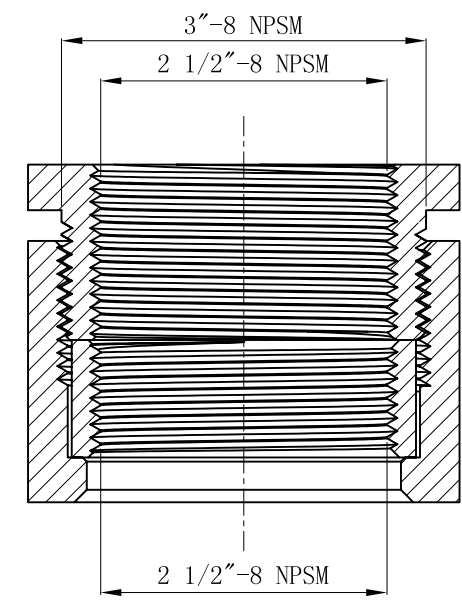
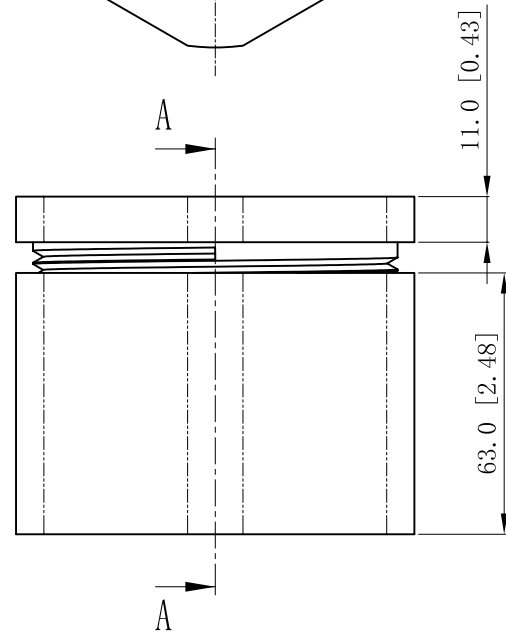
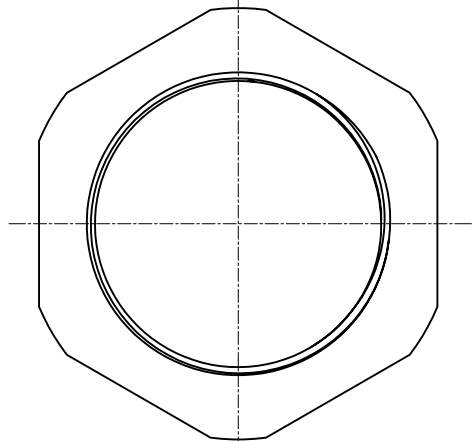
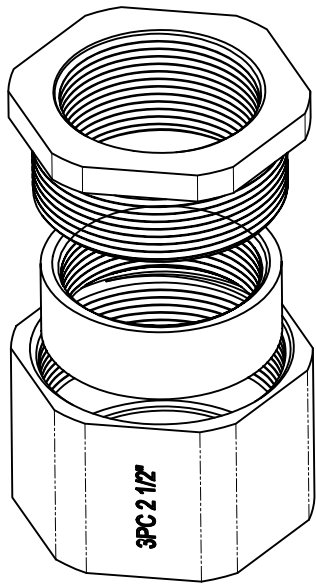

CUTAWAY VIEW A-A

This data sheet is for reference only .GARVIN INDUSTRIES reserves the right to make changes to the design without prior notice.

DESCRIPTION
TRADE REFERENCE TERMS

STANDARD PACKING
2 PCS

GARVIN INDUSTRIES		
TITLE THREE-PIECE COUPLING		
SIZE A4	DWG NO. 3PC250	REV
DATA SHEET		