



XOIL3622KSE

ALL-IN-ONE INSERT BLOWER + LINER

HOW BEAUTIFUL KITCHENS BREATHE

1000
CFM



XOIL3622KSE

- Combination Blower and SS Liner in One
- 3 speed electronic illuminated controls
- Dimmable 3000K LED lights (x2)
- 5 Minute delay function

POWERFUL 1000CFM INSERT BLOWER + LINER

The XOIL series are designed as all-in-one blower / liner combination units for easy installation into custom hoods. Each XOIL model is designed and crafted in Italy to incorporate a multi-speed blower, controls, filtration, LED Lamps and back flow damper. The XOIL is everything you need in one easy to install package.

At XO, we believe that a good design is something everyone can afford

WORLD CLASS SERVICE | COMPREHENSIVE WARRANTIES

OUR LASTING COMMITMENT TO YOU



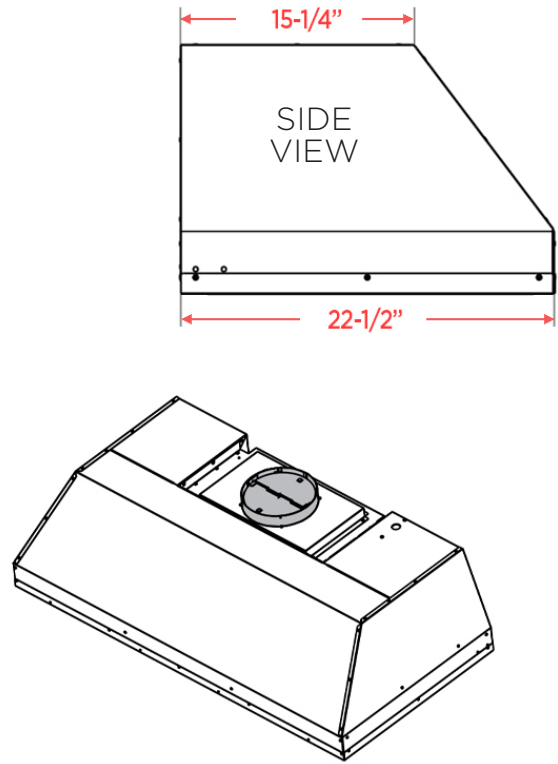
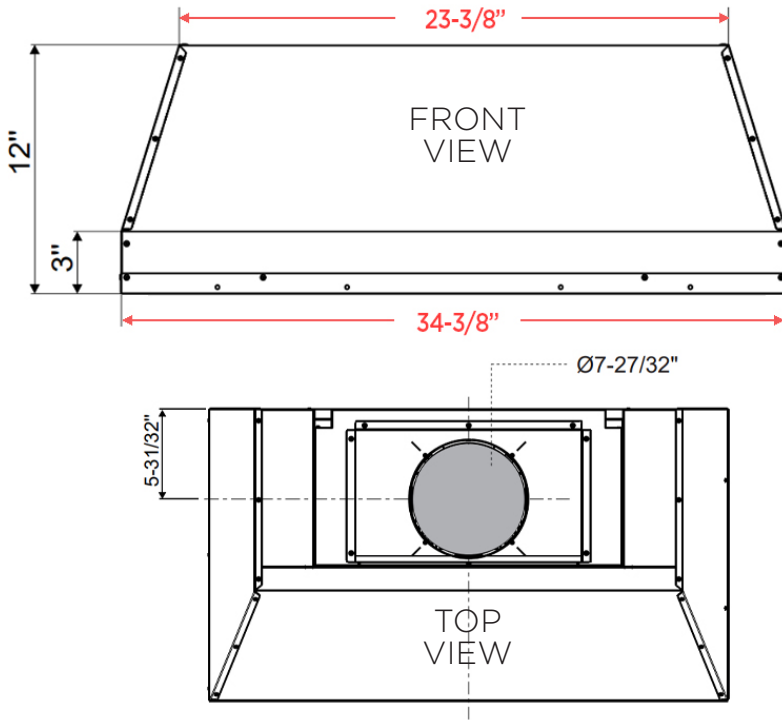

FEATURES

FINISH

Stainless Steel

FEATURES

- **POWERFUL 1000 CFM MAXIMUM AIRFLOW**
- Electronic 3 Speed Control
- High Efficiency Dimmable 3000k LED lights
- High Velocity Blower optimally removes Smoke, Grease and Odors
- Optional ADA Compliant Wireless Remote Control
- Dishwasher Safe Stainless Steel PRO Baffle Filters
- 8" Vertical Duct
- 5 Minute Delay Shutoff Timer
- Made In Italy

PERFORMANCE

SPEED	1	2	3
CFM	200	590	1000
SONES	2.0	6.4	8.0

SPECIFICATIONS

ELECTRICAL 115V 60HZ 6.6 AMP

DIMENSIONS

H 12"
W 34-3/8"
D 22-1/2"

CUTOUT DIMENSIONS

XOIL3622KSE 34-1/2"W x 22-5/8"H

MOUNTING HEIGHT

ABOVE COOKING 27" - 32"

OPTIONS

Wireless ADA Compliant Remote Control **XOVREMOTE1**

Optional 8" Automatic Make-Up Air Kit **XOMA08**

RECOMMENDED MOUNTING HEIGHT

All range hoods have a recommended range of installation height over the cooking surface. However cooking styles, types of cooking equipment and installation limitation can vary greatly. For installations outside the recommended range - consult XO.

THIS MODEL HAS AN 8" DIAMETER EXHAUST DUCT

MAKE-UP AIR

Many states have adopted regulations regarding the re-introduction of make-up air for homes with ventilation systems which can exhaust more than a specified volume of air, typically 400 CFM.

Your cooking equipment and use determine how much ventilation you need. If your local building codes require a make-up air solution based on that need, XO has the answer.

XOMA MAKE-UP AIR KITS

Make-Up Air Kits consist of two parts.

1. A sensor collar which is mounted in the exhaust duct of the hood.

This contains a feather switch that is activated when air flow is detected in the duct.

2. A motorized air inlet damper which is usually mounted to the home's HVAC system.

When it receives a signal from the sensor collar, the damper automatically opens to admit fresh air which is distributed via the HVAC system.

When the blower shuts off, the feather switch returns to the off position and the motorized damper is deactivated. The air inlet damper is automatically closed by a return spring.

