



**IMPORTANT**

Carefully remove all the parts from the carton and place them individually on a soft cloth to prevent scratches or other damage.

Carefully and strictly follow these assembly instructions to ensure a completed product as designed.

Do not use power tools above 8 volts to assemble.

**Part List**

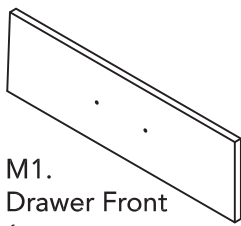

M1.  
Drawer Front  
1 pc.

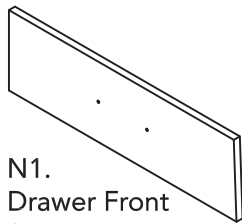

N1.  
Drawer Front  
1 pc.

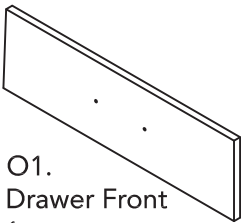

O1.  
Drawer Front  
1 pc.

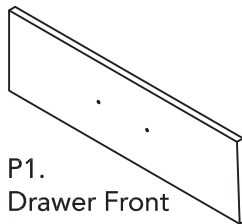

P1.  
Drawer Front  
1 pc.

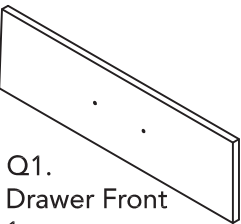

Q1.  
Drawer Front  
1 pc.

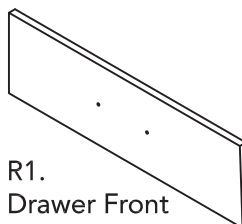

R1.  
Drawer Front  
1 pc.

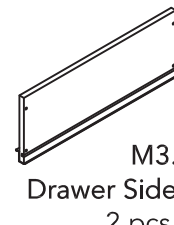

M3.  
Drawer Side  
2 pcs.

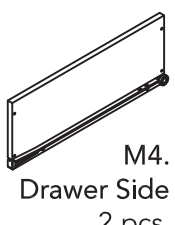

M4.  
Drawer Side  
2 pcs.

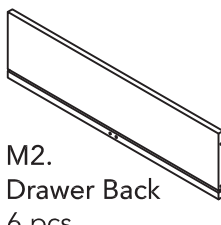

M2.  
Drawer Back  
6 pcs.

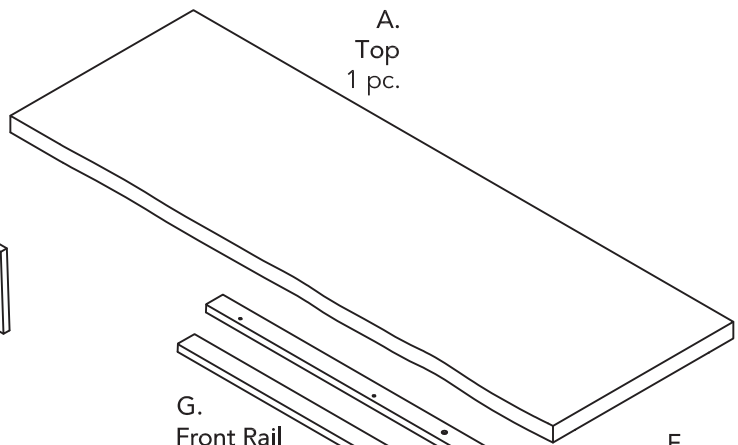

A.  
Top  
1 pc.

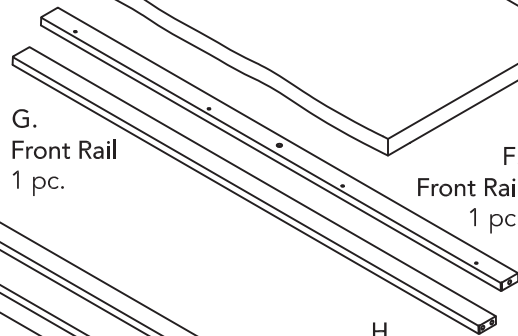

G.  
Front Rail  
1 pc.

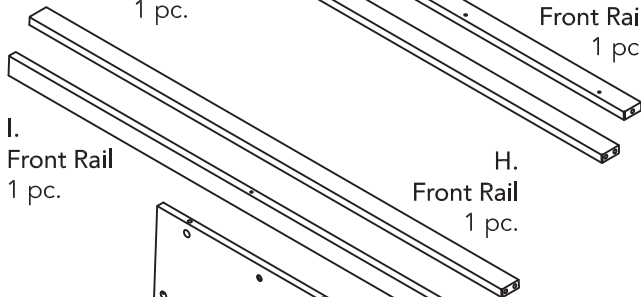

F.  
Front Rail  
1 pc.

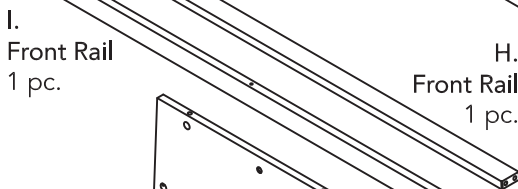

H.  
Front Rail  
1 pc.

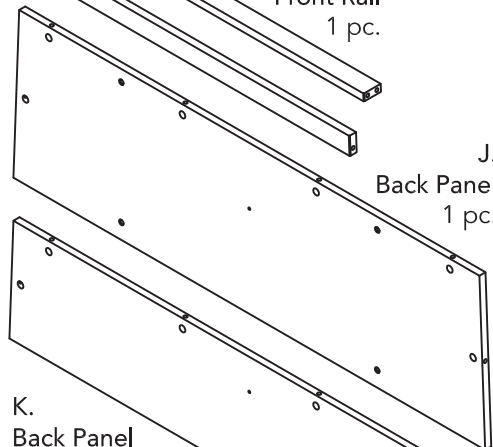

J.  
Back Panel  
1 pc.

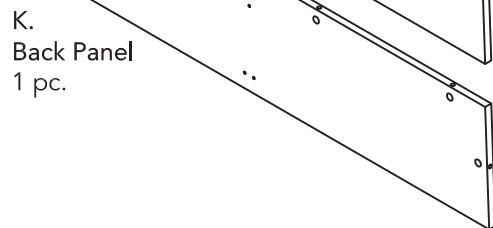

K.  
Back Panel  
1 pc.

For assembly see instructions in carton 5185-432