

# SIMPLIHOME®

## Lowell / Calinda / Ridley

---

### Bentwood Dining Chair

MODEL # AXCLOW-LG

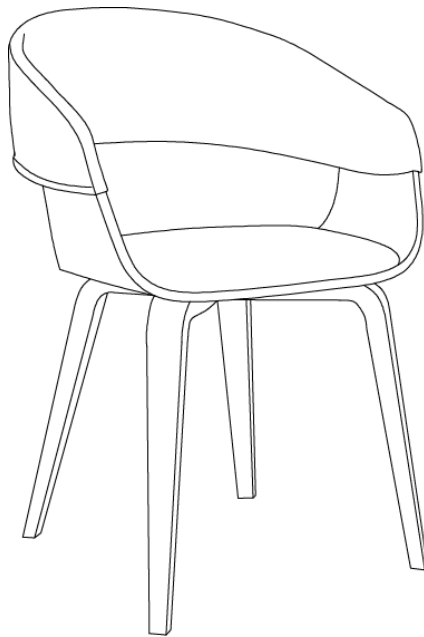

# SIMPLIHOME®

## Great quality is a right.

Thank you for shopping with Simpli Home,  
America's top brand for high-value furniture.



## It's time to register your product warranty.

It's quick and easy. And you'll be happy you did.



- ✓ Activate your 1-year warranty.
- ✓ Automatic entry to win a \$500 gift certificate.
- ✓ Earn instant rewards and save.

[simpli-home.com/product-registration](https://simpli-home.com/product-registration)

# SIMPLIHOME®

## Review your product and collect rewards!

Thank you for your purchase! We hope you enjoy it. We'd love your feedback. Please share a review and get instant rewards!



[simpli-home.com/product-review](https://simpli-home.com/product-review)



## Share photos and get your cash back!



Send us images or share them on social and qualify for instant rewards. You may even receive store credit on your entire purchase!



[simpli-home.com/share-images](https://simpli-home.com/share-images)

# SIMPLIHOME®

## For fastest customer service:

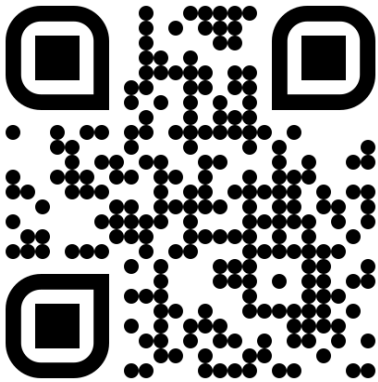

1. Open your phone's camera.
2. Point your phone's camera at the QR code to scan.
3. Click on the pop up.
4. You'll be taken to our customer service page.
5. Fill the form with your order information and issue.
6. Submit form.
7. A customer service associate will contact you.

## Other ways to contact us...



### Email Us

[customerservice@simpli-home.com](mailto:customerservice@simpli-home.com)



### Visit Us

Visit our site directly at  
[www.simpli-home.com](http://www.simpli-home.com)



### Call Us

1-866-518-0120  
Monday to Friday  
9am to 5pm EST

**\*If you've purchased from a retailer and you wish to return the product, please contact the retailer directly.**

**IMPORTANT:** Please read this manual carefully before beginning assembly of this product. Keep this manual for future reference.

## Safety Information

**This furniture is designed for indoor use.**

Identify all the parts and hardware. Do not discard of the packaging until you have checked that you have all the parts and hardware required. Hardware package may have spare parts.

**WARNING:** This item contains small parts which can be swallowed by children and pets. Keep children and pets away during assembly. To avoid danger of suffocation, always keep plastic bags away from children and pets.

We recommend that you assemble this unit on a carpeted floor to avoid scratches. If using power tools, set the tool to low torque to avoid damage.

**May require 2 people for ease of assembly.**

## Care & Maintenance

Wipe regularly with clean water and a damp, clean, soft white cloth.

General cleaning can be done as needed with a mild detergent and water solution.

Always rinse with clean water and dry.

For heavy soiling, dampen a soft white cloth or soft bristle brush.

Use care as scrubbing can damage the surface.

More difficult stains can be treated, but this should be occasional, not daily cleaning.

ANY cleaning solution used must be removed with clean water and a clean white cloth. Cleaning residue left on the material can cause it to dry out and crack or affect the color.

**DO NOT** use any cleaners with corrosive ingredients (lye, acids or ammonia).

**Part Description**

**A**

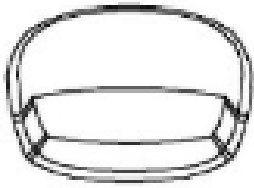

SEAT  
QTY 1

**B**



LEG  
QTY 1

**C**



LEG  
QTY 1

**Hardware Description**

**1**

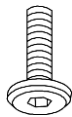

ALLEN KEY SCREW  
M6 x 27 mm  
QTY 1

**2**

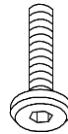

ALLEN KEY SCREW  
M6 x 40 mm  
QTY 4

**3**



ALLEN KEY  
QTY 1

**4**



WASHER  
QTY 5

## Step 1

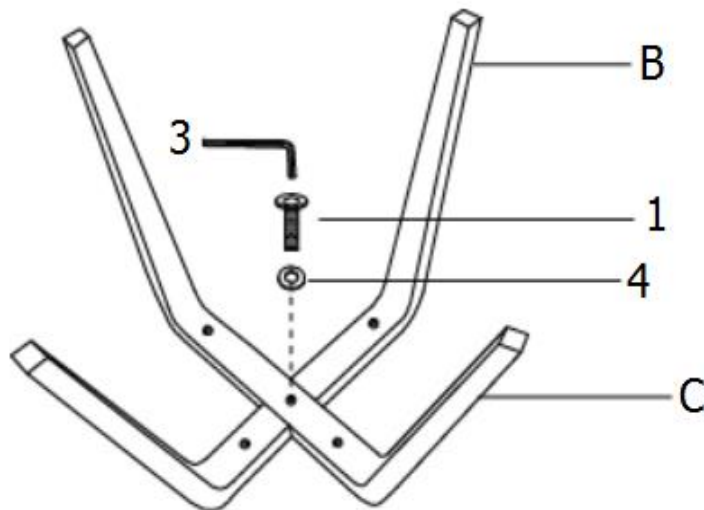

1. Attach Leg (B) to Leg (C) using Allen Key Screw (1) and one Washer (4).
2. Use Allen Key (3) to tighten. Do not over-tighten.

Step 2

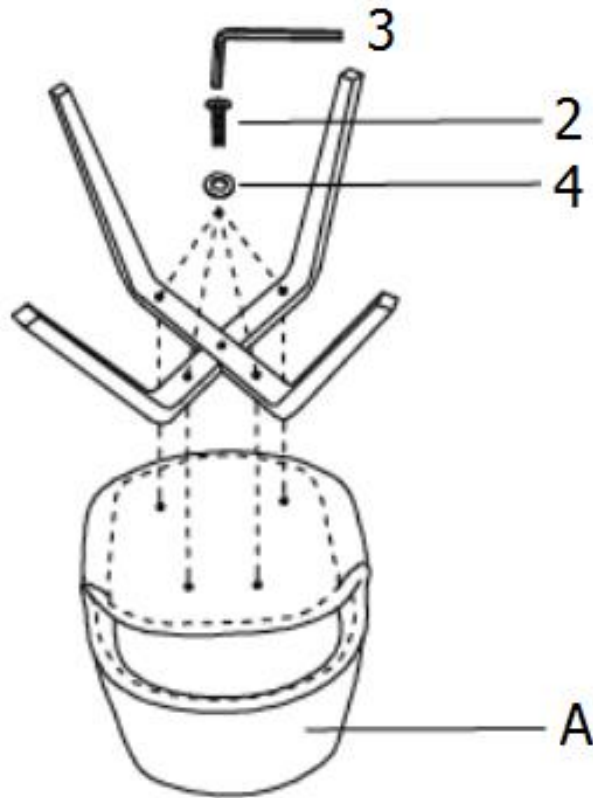

1. Attach Legs to the bottom of Seat (A) using Allen Key Screws (2) and four Washers (4).
2. Use Allen Key (3) to tighten.

**Step 3**

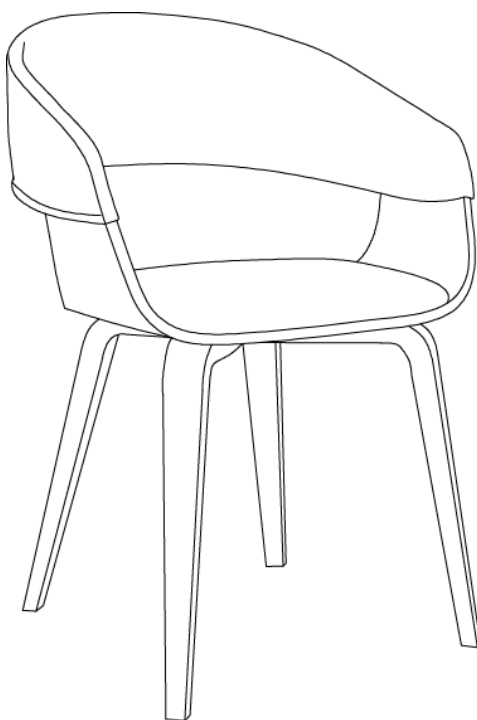

I. Turn Chair right side up.