







# ASSEMBLY INSTRUCTION

ITEM: 6025-85004-40 Vecchia Three-Drawer Chest

Thank you for purchasing this quality product. Be sure to unpack carefully looking for small parts which may have come loose during shipment.  
Read all instruction and study the drawing carefully before starting the assembly process.

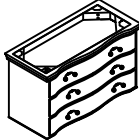
HARDWARE PACK				
NO.	DRAWING	DESCRIPTION	SIZE	Q'TY
A		Flat Washer	Ø5/16"	8PCS
B		Lock Washer	Ø5/16"	8PCS
C		Bolt	Ø5/16"	8PCS
D		Allen Wrench	73*29*5mm	1PC
E		Anti - Tip Kit		1PC

PARTS LIST			
NO.	DRAWING	DESCRIPTION	Q'TY
1		Case Body	1PC
2		Leg	4PCS

**NOTE: KINDLY MATCH THE NUMBERS ON LEGS AND CORNER BLOCKS WHEN ASSEMBLE.**

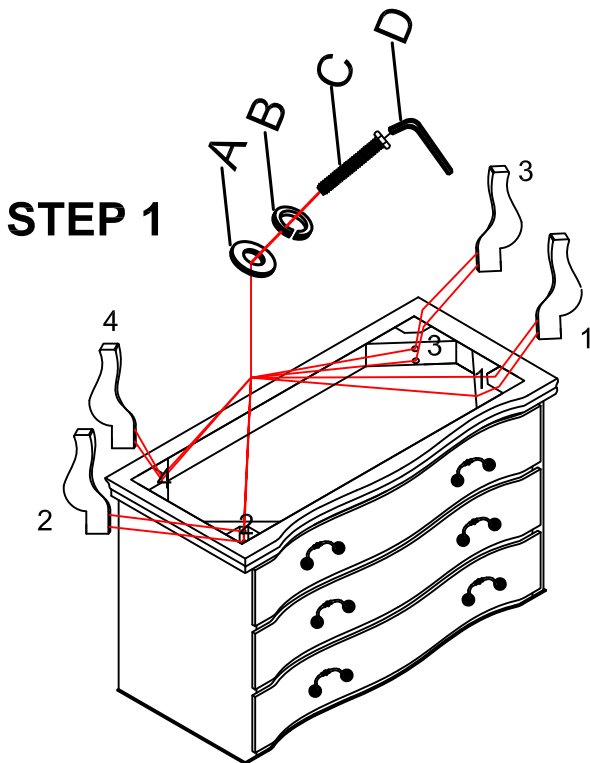

Attach legs (2) to the holes at the bottom corners of case body (1), tighten all with flat washers (A), lock washers (B) and bolts (C) by using allen wrench (D).

Tipping Restraint

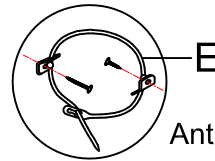

Anti-tip kit is included for use. We recommend installing for safety reason

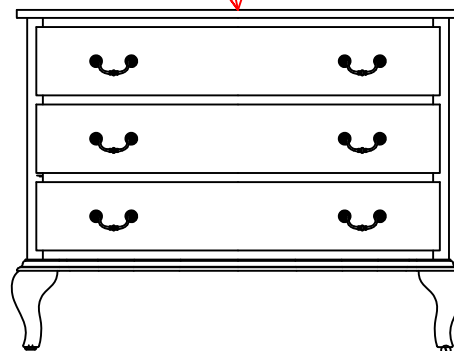

**STEP 2**

Adjust Leveler if needed to level chest on uneven floor.

