

SIDES	BOTTOM
Material: Steel-C.R.S Zinc Plated	

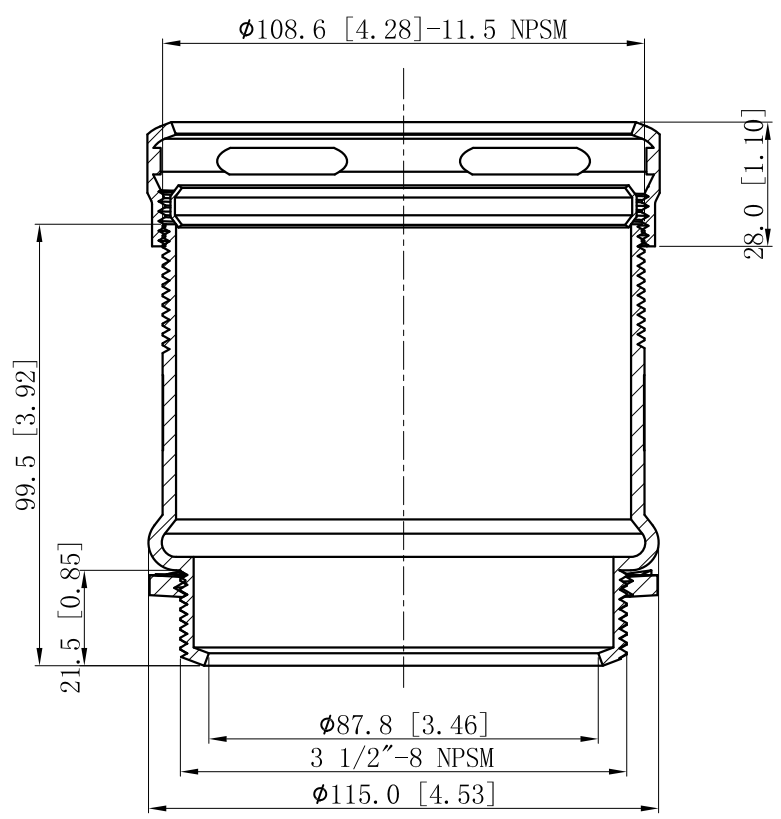

CUTAWAY VIEW A-A

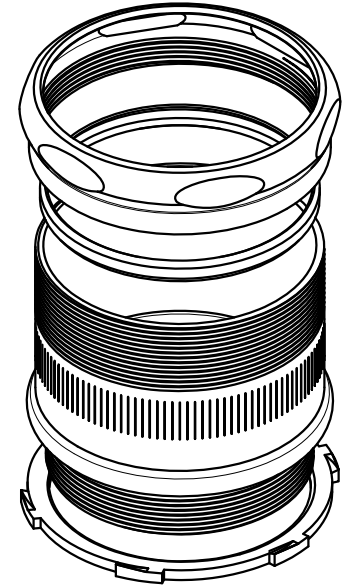
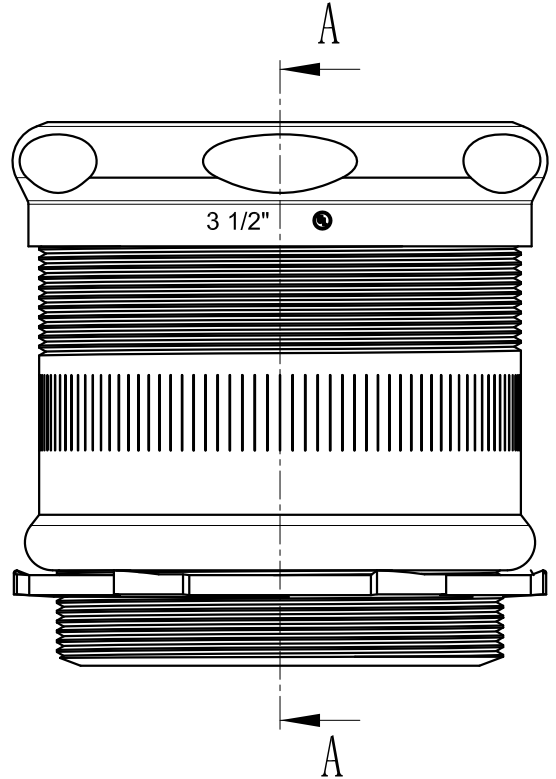

DESCRIPTION
TRADE REFERENCE TERMS

This data sheet is for reference only .GARVIN INDUSTRIES reserves the right to make changes to the design without prior notice.

STANDARD PACKING	<h1 style="margin: 0;">GARVIN INDUSTRIES</h1> <h2 style="margin: 0;">STEEL EMT SET COMPRESSION CONNECTORS</h2>		
5 PCS			
SIZE	DWG NO.	CCN-350	REV
A4			
DATA SHEET			