







Thank you for purchasing this quality product. Be sure to unpack carefully looking for small parts which may have come loose during shipment.

Read all instruction and study the drawing carefully before starting the assembly process.

HARDWARE PACK					PART LIST			
NO.	DRAWING	DESCRIPTION	SIZE	Q'TY	NO.	DRAWING	DESCRIPTION	Q'TY
A		Allen Wrench		1pc	①		Table Top	1PC
B		Bolt	108MM*14MM	4pcs	②		Post	4PCS
C		Adj. Leveler	28m	4pcs	③		Bottom Shelf	1PC

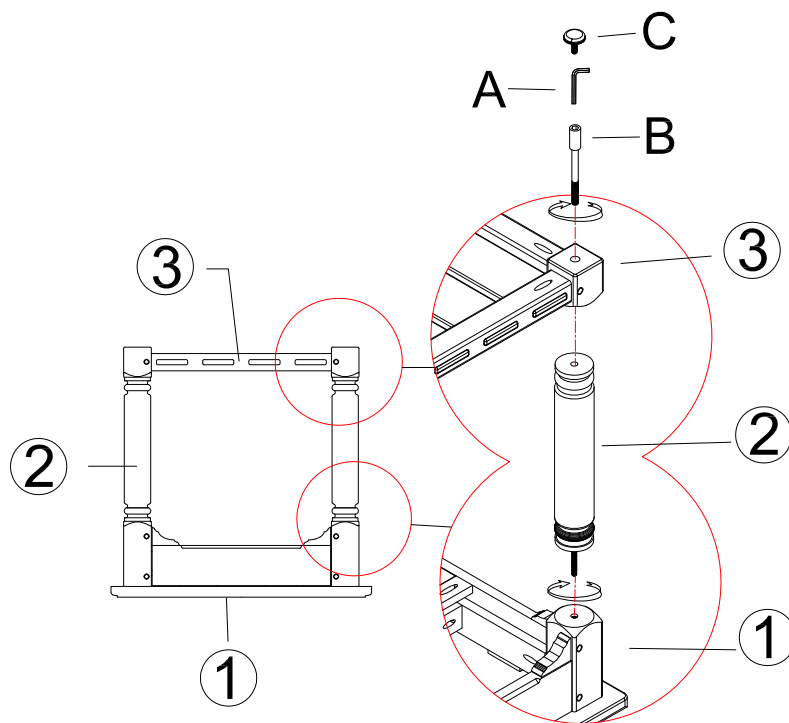

Step 3:
Insert bolts (B) to bottom shelf (3) and tighten them by allen wrench (A), well screw adjustable levelers (C) to bolts (B).

Step 2:
Put bottom shelf (3) onto the posts (2).

Step 1:
Attach posts (2) to table top (1).

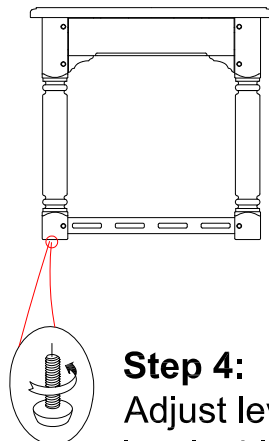

Step 4:
Adjust leveler if needed to level table on uneven floor.