

Thank you for choosing Sunnydaze Decor. We stand behind our brand and the quality of the items we sell. Replacement parts or products will be sent at our discretion within the 1-year warranty period. Proof of purchase, with the date of purchase as well as photos of the merchandise defect, must be provided. Photos are used to determine the cause of defects and for future quality control. Register your warranty at <https://tiny.cc/SunnydazeWarranty>. If you have any questions, comments or concerns, feel free to contact us by phone at 833-982-1977, by email: customerservice@sunnydazedecor.com, or via our contact us page at <https://tiny.cc/SunnydazeContact>

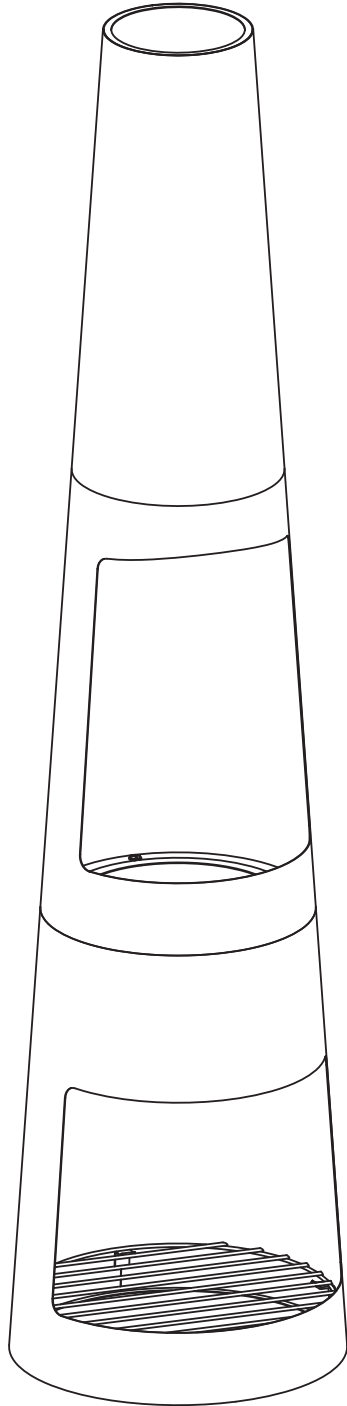





BLACK STEEL CHIMINEA

FSN-1851

Review all assembly and care information before using this product. Save this manual for future reference.
Assemble components on a soft, clean surface to avoid damaging the finish.



Inspect packaging to ensure all parts are accounted for before disposing of packing materials.
 Save the packing slip.

No.	PARTS		QTY.
A		Flue	1
B		Main Body	1
C		Base	1
D		Fire Bowl	1
E		Wood Grate	1
F		Poker	1

No.	HARDWARE		QTY.
1		M6x20mm Bolt	6

TOOLS REQUIRED (not included)		
		Phillips Screwdriver

⚠ WARNING ⚠

CHOKING HAZARD — This item contains small parts that can be swallowed. Keep children and pets away during assembly.

⚠ WARNING:

Manufacturer and seller expressly disclaim any and all liability from personal injury, property damage or loss, whether direct or indirect, or incidental, resulting from the incorrect attachment, improper use, inadequate maintenance, or neglect of this product.

ASSEMBLY

STEP 1

A: 1

B: 1

1: 3

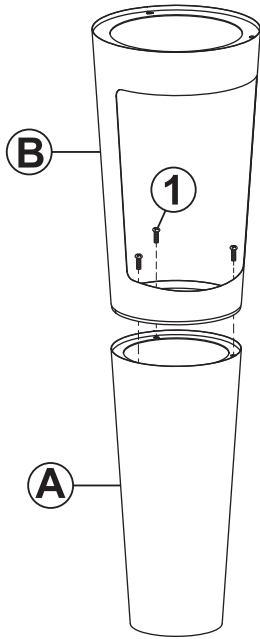

Place Flue (A) upside-down on a soft, clean surface.

Align Main Body (B) and secure using three M6x20mm Bolts (1).

STEP 2

C: 1

1: 3

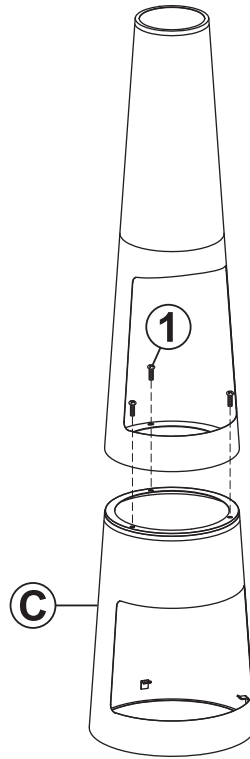

Secure the assembled components on Base (C) using three M6x20mm Bolts (1).

STEP 3

D: 1

E: 1

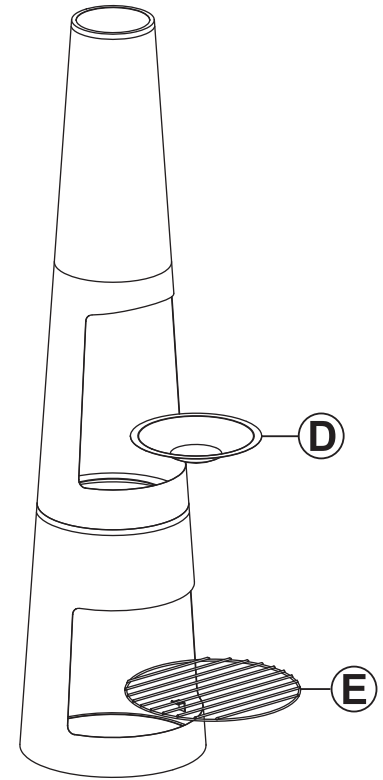

Place Fire Bowl (D) in the main body and Wood Grate (E) in the base.

CARE & MAINTENANCE

SAFE USE: Only use a chiminea on a flat, non-combustible surface such as concrete, rock, or stone. Do not use this fire pit on a wood deck or any other combustible surfaces like dry grass, leaves, mulch, etc. Never use in an area with an overhead structure or near any unprotected combustible constructions like vinyl or wood siding. Avoid using near or under overhanging trees and shrubs.

The unit will become extremely hot while in use. Always use the poker and heat-resistant gloves when maintaining a fire.

NO ACCELERANTS, NO PLASTICS: Never use an accelerant, i.e. gasoline or kerosene, to start a fire; doing so is dangerous and can damage the chiminea.

Never use any plastic materials in or near a fire. The emissions from burning plastic are toxic. Additionally, plastic residue is very difficult to remove.

EXTINGUISH: Let fires die down gradually and go out on their own. DO NOT use water to put out a fire as the sudden drop in temperature may cause serious injury and/or damage the metal.

EXPOSURE & MAINTENANCE: Long-term exposure to high-intensity heat can cause the high-temperature paint to flake or burn off the steel. If the paint burns off the steel and is exposed to moisture, it will rust. As with any outdoor steel product, periodic maintenance is required to maintain integrity and appearance. Remove rust and refinish with a suitable high-temperature paint; carefully follow the paint manufacturer instructions and ensure the paint is completely dry before using the unit again.

CLEANING: Remove ashes and debris before every use. Ensure the chiminea and ashes are completely cool before cleaning. Ashes can remain hot long after a fire dies down. If you feel heat when your hand is close to the metal or the ashes, the unit is too hot to clean.

COVER AND STORE: Ensure the entire unit is completely cool before covering. Always clean the unit before covering it. Do not allow the fire pit to be exposed to water. Store in a dry location to protect it from the effects of environmental elements. The manufacturer is not liable for damage resulting from general use and/or environmental conditions.

WARNING: THE ONE-YEAR WARRANTY DOES NOT COVER DAMAGES OR DEFECTS CAUSED BY THE APPLICATION OF CHEMICAL TREATMENTS, PROTECTIVE COATINGS, TOUCH-UP PAINT, OR CLEANING PRODUCTS.

SAFETY STATEMENTS & WARNINGS

- For outdoor use only. Never use this product in an enclosed area.
- Always follow local laws and regulations when using wood-burning fire pits and chimineas.
- Exercise the same care and precautions as you would with an open fire.
- Always supervise children and pets when they are in proximity of this product, whether it is in use or not in use.
- Never use any fire pit or chiminea during dry or windy conditions.
- Keep unit a safe distance away from buildings, balconies, or overhangs when in use.
- Do not use on or near combustible surfaces or structures such as wood decks, dry leaves or grass, mulch, vinyl or wood siding, etc.
- Only use this unit on a level, non-combustible surface.
- Keep away from all combustible materials including gasoline and other flammable liquids and vapors.
- Never use accelerants such as, but not limited to, gasoline, alcohol, paint thinners, kerosene, as this may cause serious injury or product damage.
- Do not overfill or use this unit or use it to burn leaves or trash.
- This unit becomes very hot when in use and can remain hot for a long time after fire is extinguished. Ensure the unit is completely cool before cleaning or moving it.
- Never leave unit unattended while hot or in use.
- Extinguish the fire properly before leaving the unit unattended. If necessary, use a fire extinguisher or sand to smother the fire. NEVER use water to extinguish hot fires or embers as doing so may cause serious injury and/or permanently damage the product.
- Ashes can remain hot for a long time after fire is extinguished. Dispose of cold ashes properly.
- Ensure the unit is completely cool before covering, failure to do so will damage the cover and the unit.
- DO NOT USE CHEMICAL-BASED CLEANERS as this may damage the product and/or ignite a flame during the next use.

Contact the local authorities regarding possible burn restrictions before using this product.

Any modification to the product or failure to follow recommended care will void the product warranty.

If you experience issues with assembly or the product was damaged during shipping, please contact our customer service team through one of the methods mentioned at the top of page 1.

Please have the item number and order information ready to expedite response time.

WARNING:

Manufacturer and seller expressly disclaim any and all liability from personal injury, property damage or loss, whether direct or indirect, or incidental, resulting from the incorrect attachment, improper use, inadequate maintenance, or neglect of this product.