

**Elegant Home Fashions
Corner Wall Cabinet
-Shutter Doors**

ELG-587/597

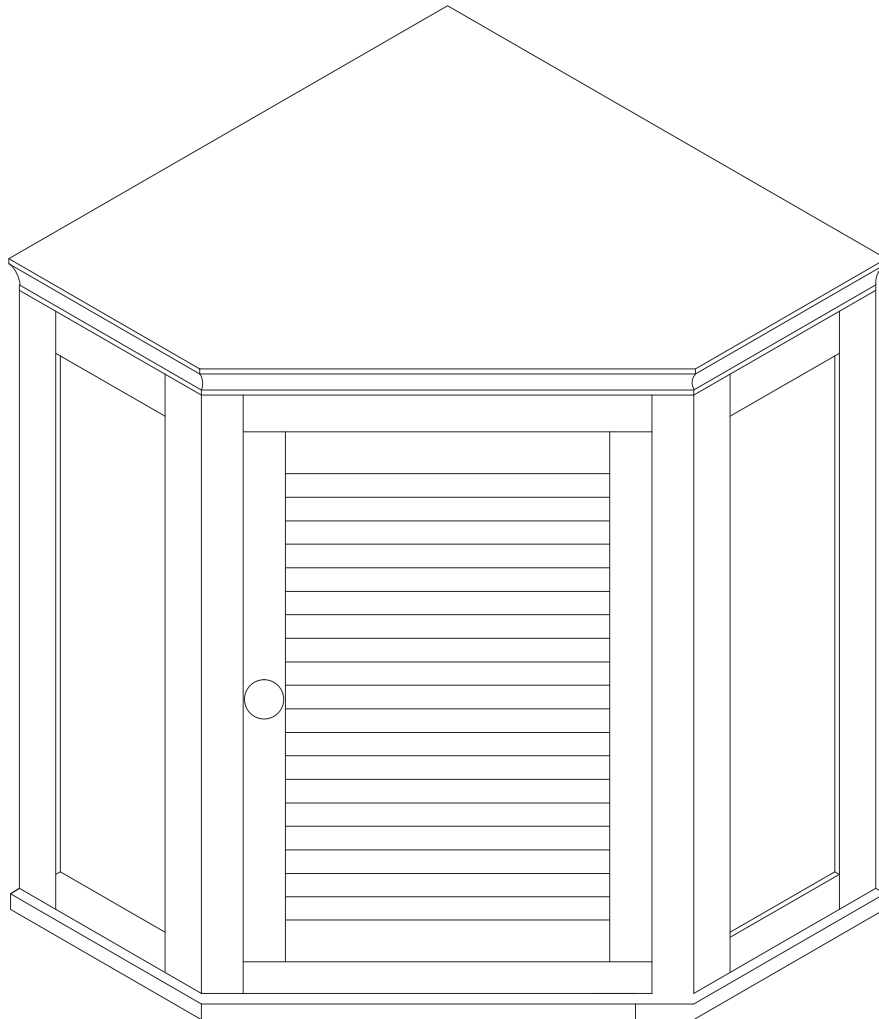

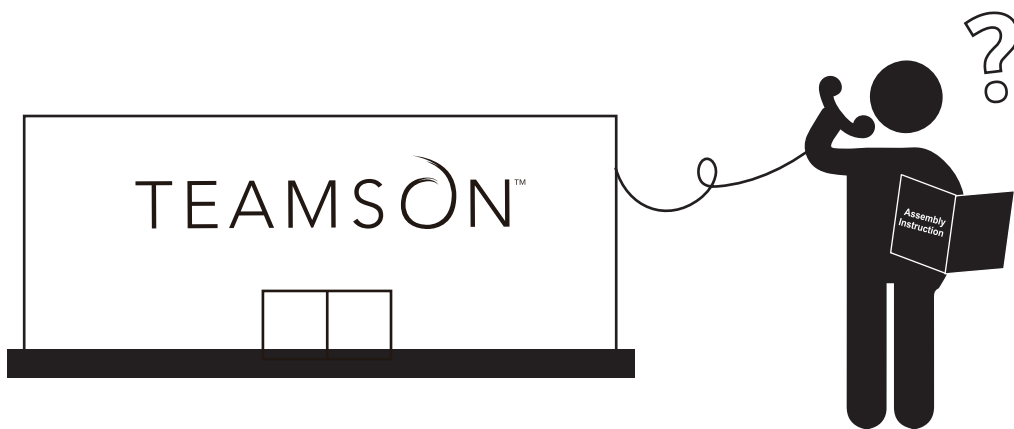
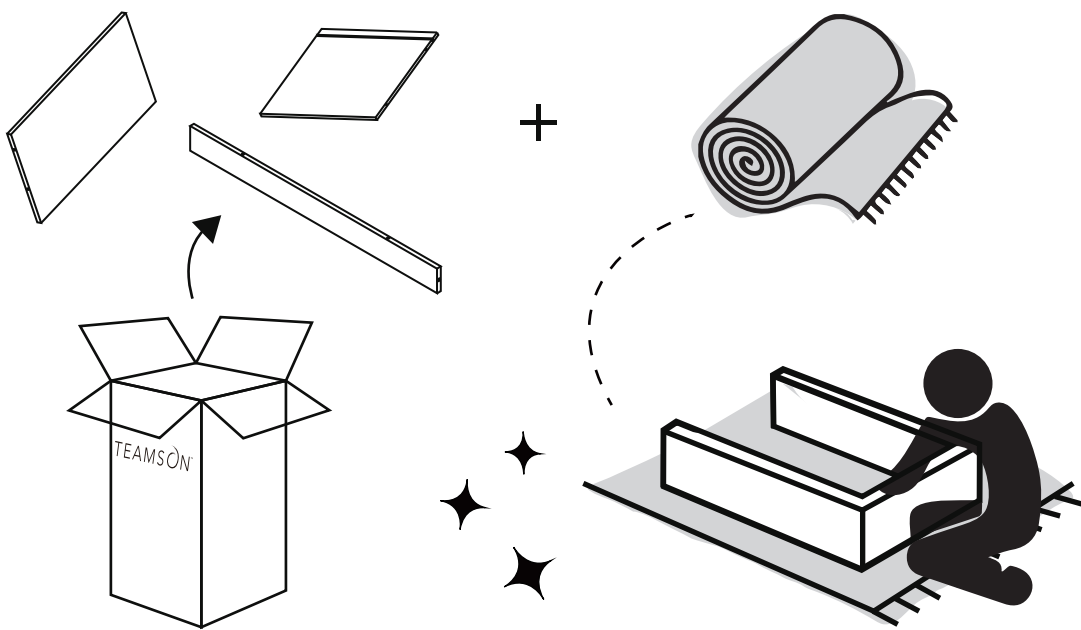
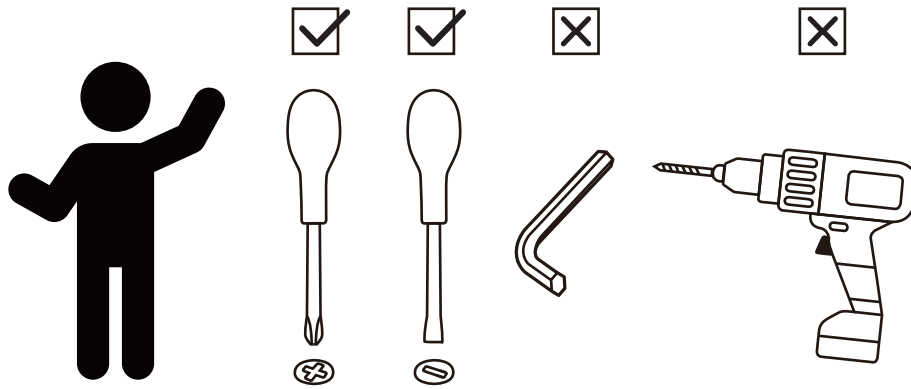

** Got questions? Please have your product code (on the first page of this instruction, e.g. TD-12345A) and the order number ready, give us a call or email us through our customer care support! We are always ready to assist you!

TEAMSON HOME



Warranty sign up

www.teamsonhome.com

Serving you well gives us great joy!

USA +1(770)-246-4898

Mon - Fri 9:00am ~ 5:00pm EST

✉ service@eleganthf.net

EU +44(0)1952-916-050

Mon - Thu 9:00am ~ 5:00pm GMT

Friday 9:00am ~ 4:00pm GMT

✉ support@teamson.co.uk

ASSEMBLY INSTRUCTIONS-IMPORTANT

Carefully unpack & identify each component before attempting to assemble. Refer to parts list. Please take care when assembling the unit and always set the parts on a clean, soft surface. If you require any assistance with assembly, parts, please call the company you place order with or please email to: service@eleganthf.net

INSTRUCCIONES PARA ARMAR-IMPORANT:

Desempaque cuidadosamente e identifique cada componente antes de tartar de empezar su ensambladura. Verifique la lista de partes. Por favor tenga cuidado cuando arme la unidad y siempre coloque las piezas sobre una superficie plana, suave y limpia. Si necesita ayuda con el armado, envíe un correo electzórico a service@eleganthf.net

DIRECTIVES DE MONTAGE-IMPORTANT:

Avant de commencer l' assemblage, déballez délicatement toutes les pièces et repérez-les sur la liste des pièces. Procédez avec soins durant l' assemblage et posez toujours les pièces sur une surface proper, douce et lisse. sie vouo plait e-mail á service@eleganthf.net

Thank you for choosing Teamson Home

Exploded Drawing

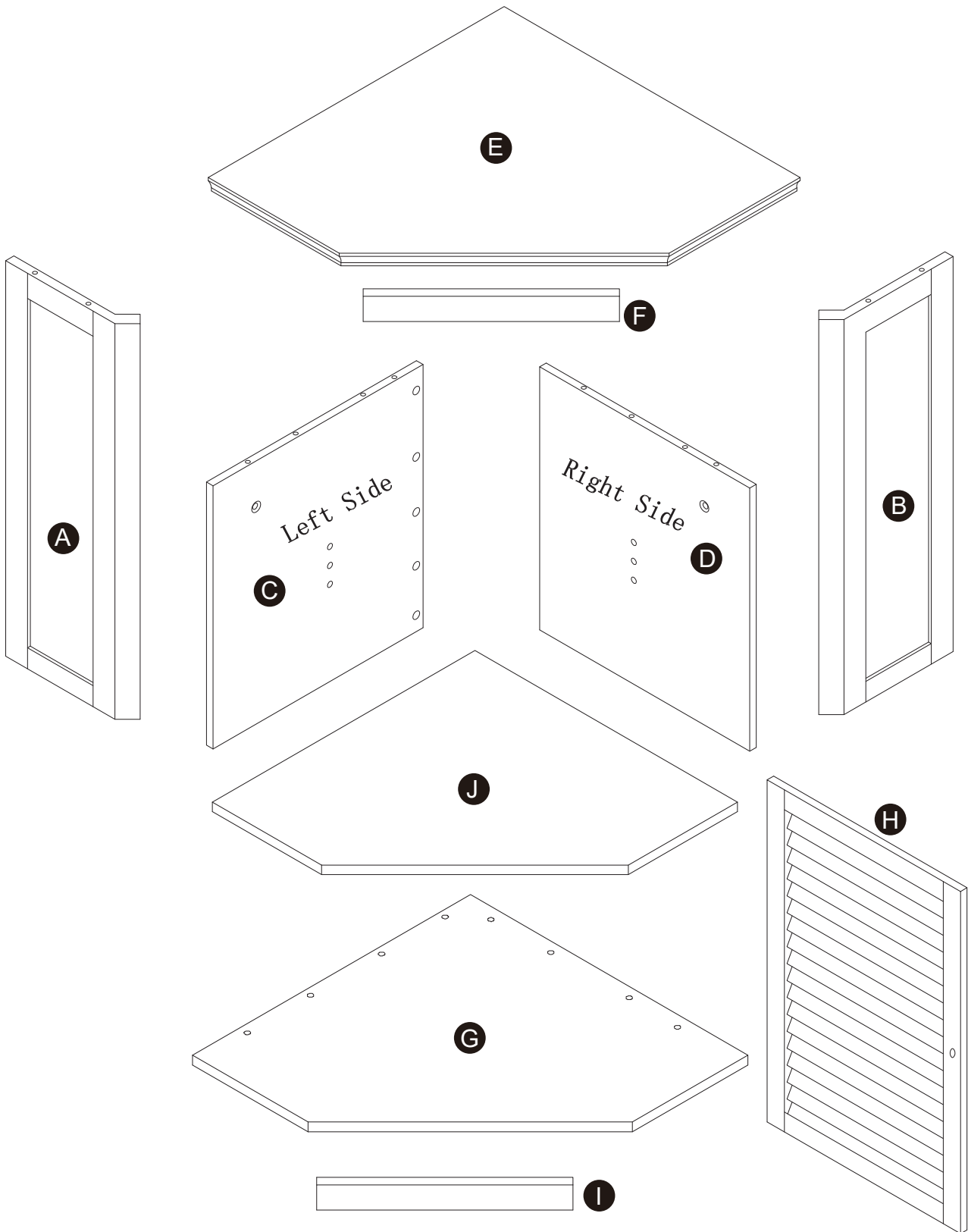

Product Parts

A

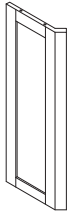

B



C

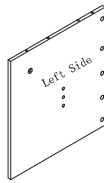

D

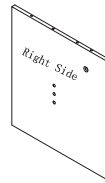

E

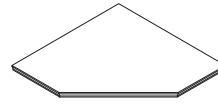

F



G

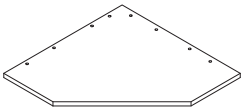

H

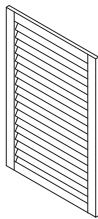

I



J



WARNING:

1. Do not let any sharp objects touch or rub the surface of the product.
2. When assembling, do not let children play around the working area.
3. Please confirm all parts are correct before starting the assembly process.
4. Do not tighten all bolts and screws completely until the entire unit has been assembled and set up.

Hardware

1

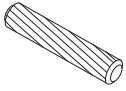

$\phi 8 \times 30$

25 pcs

2

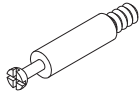

16 pcs

3

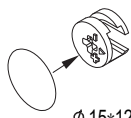

$\phi 15 \times 12$

12 pcs

4

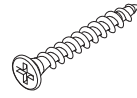

$\phi 4 \times 25$

3 pcs

5



$\phi 3 \times 12$

4 pcs

6

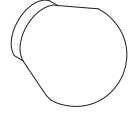

1 pc

7

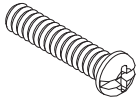

1 pc

8

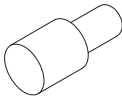

4 pcs

9

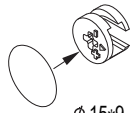

$\phi 15 \times 9$

4 pcs

10

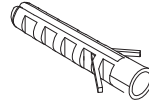

2 pcs

11

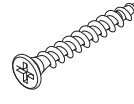

$\phi 4 \times 35$

2 pcs

TEMPLATE PAPER

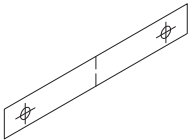

Step 1

- 1**  9 pcs
- 2**  4 pcs
- 3**  $\phi 15 \times 12$ 2 pcs
- 4**  $\phi 4 \times 25$ 2 pcs

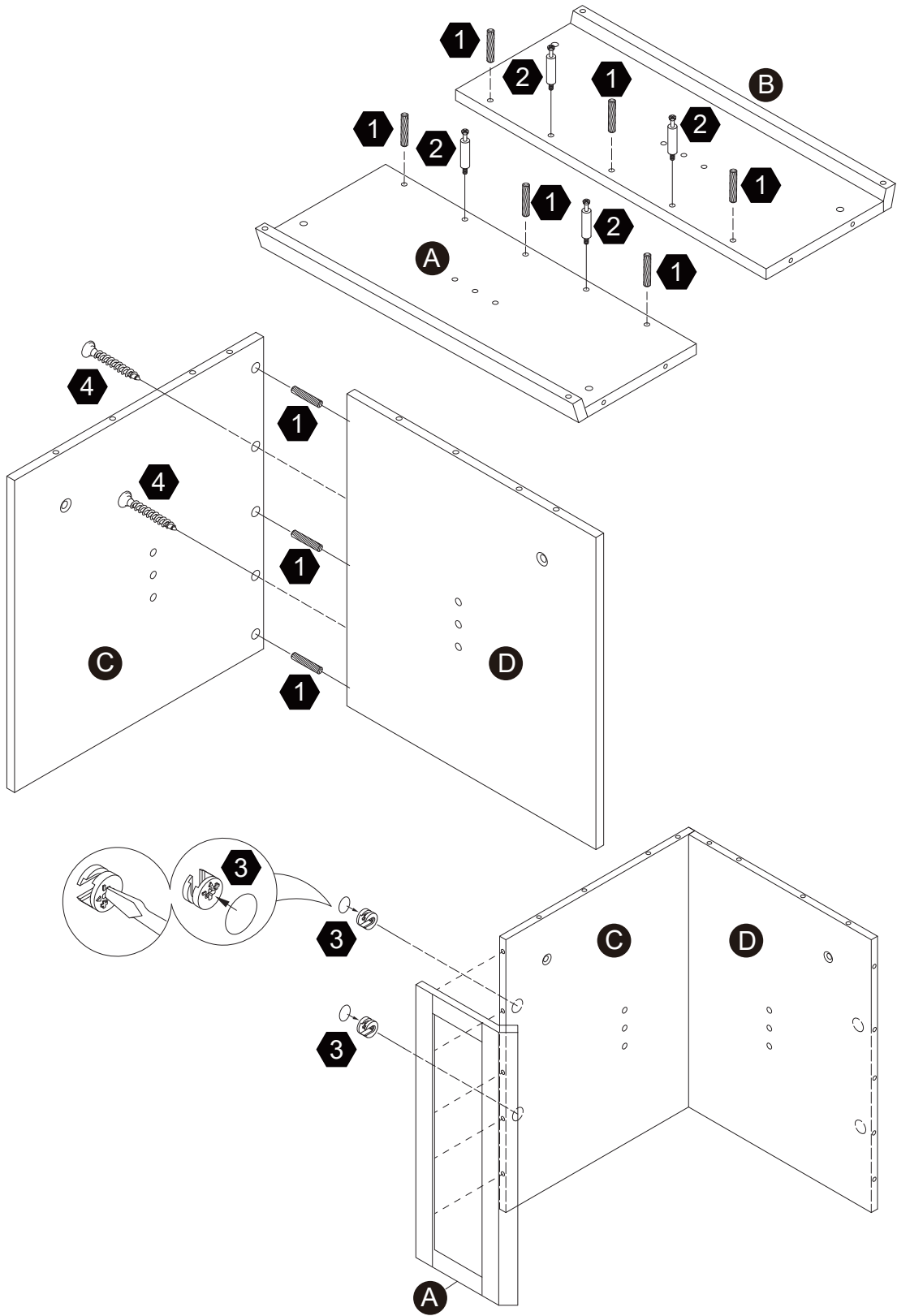

Step 2

1

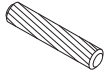

4 pcs

3



2 pcs

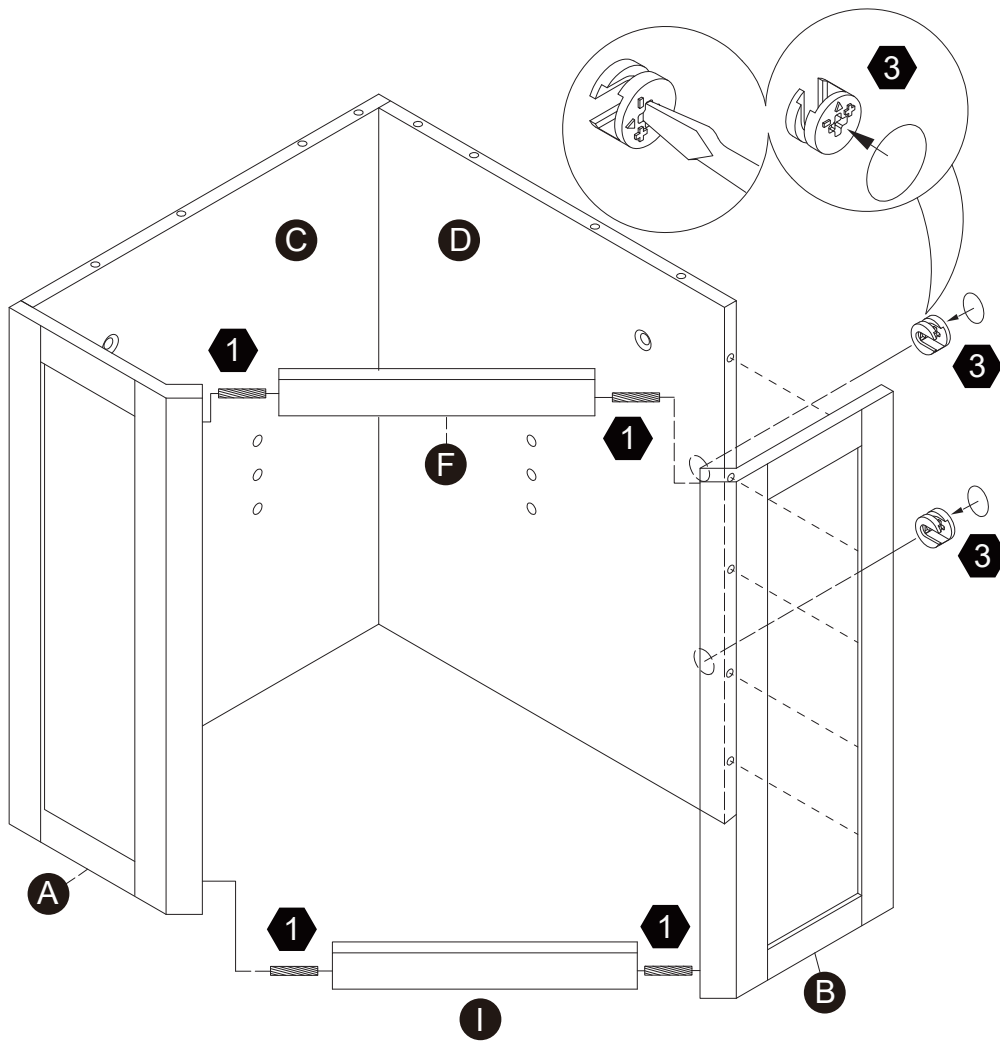

Step 3

1

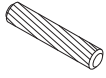

6 pcs

2

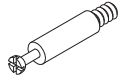

6 pcs

3

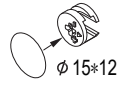

4 pcs



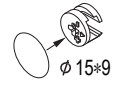

9

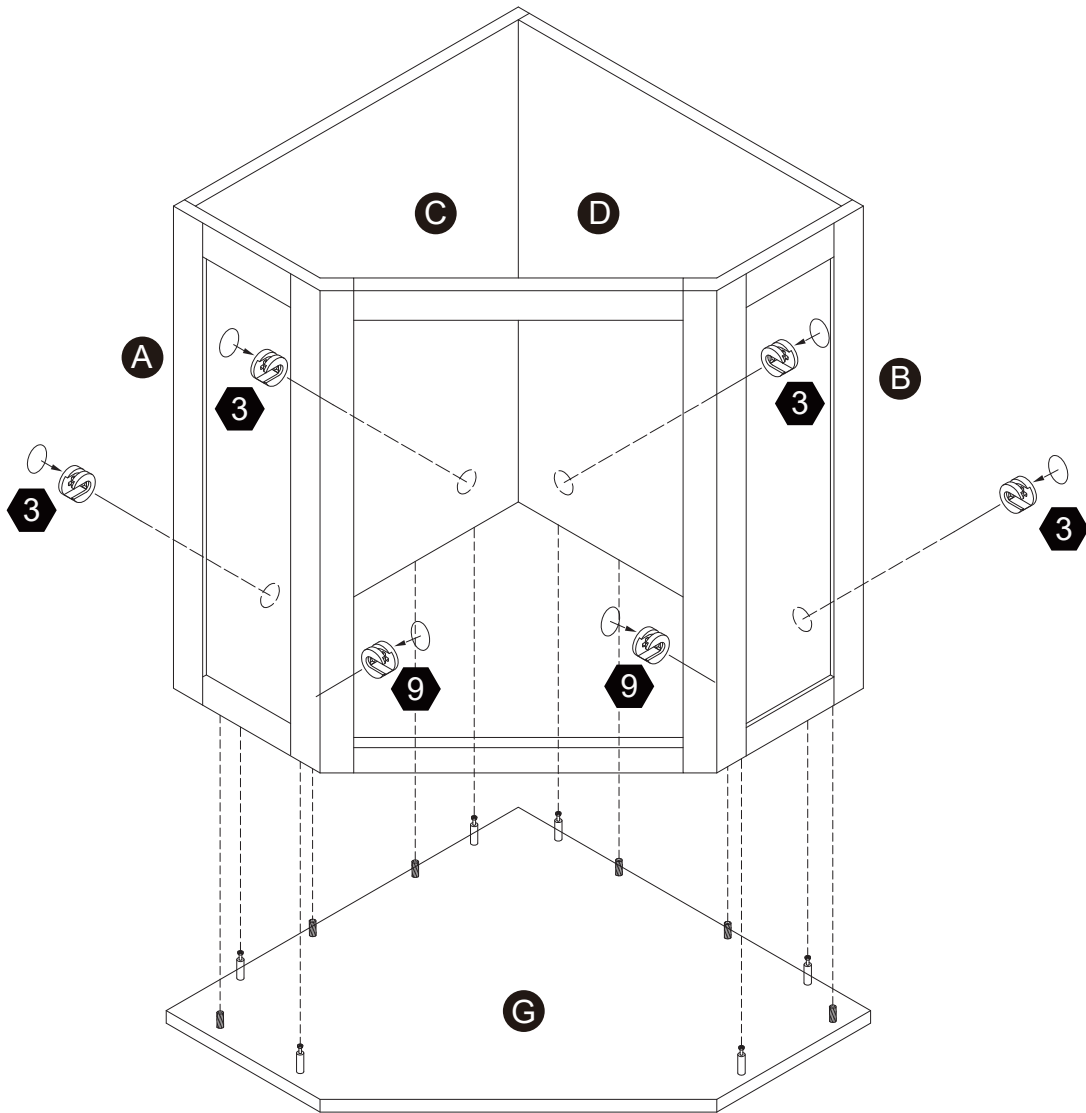
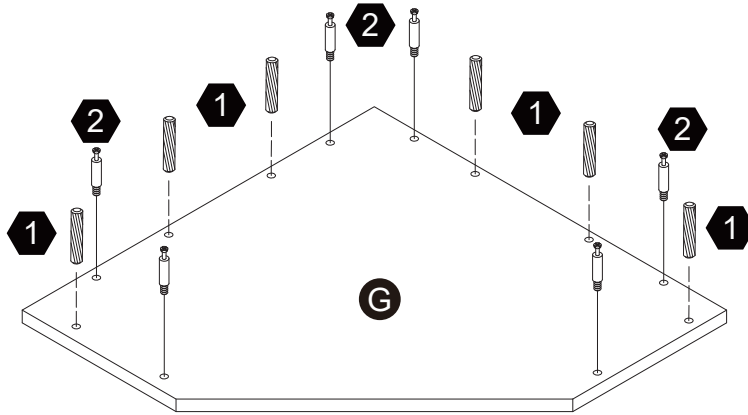

2 pcs

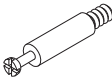

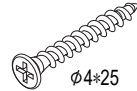
Step 4

- 1 6 pcs
- 2  6 pcs
- 3  $\phi 15 \times 12$ 4 pcs
- 4  $\phi 4 \times 25$ 1 pc
- 9  $\phi 15 \times 9$ 2 pcs

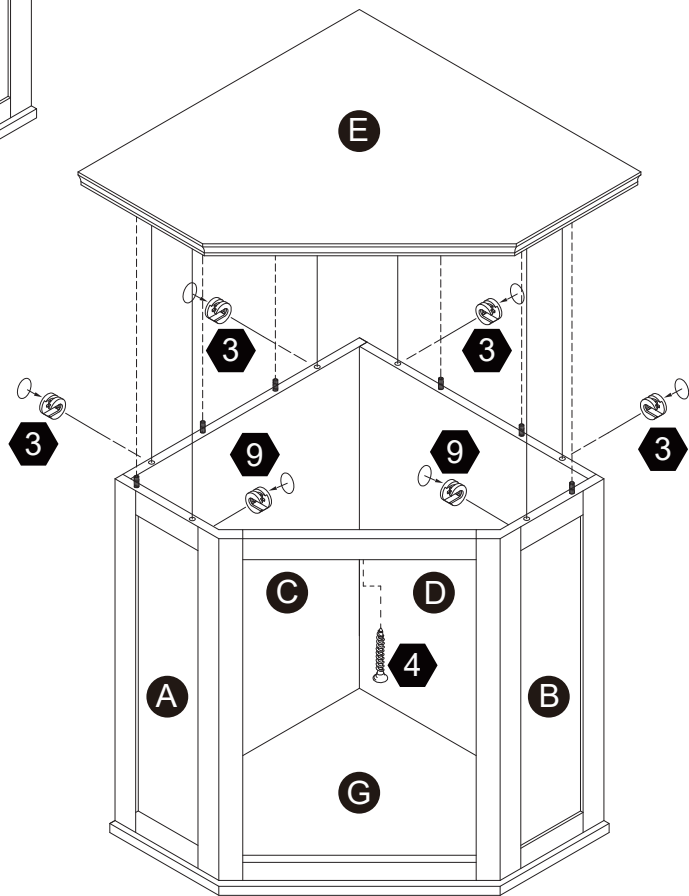
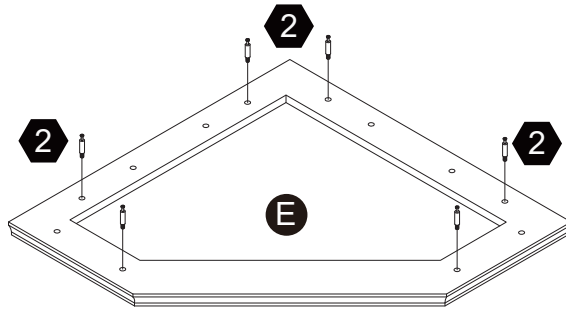
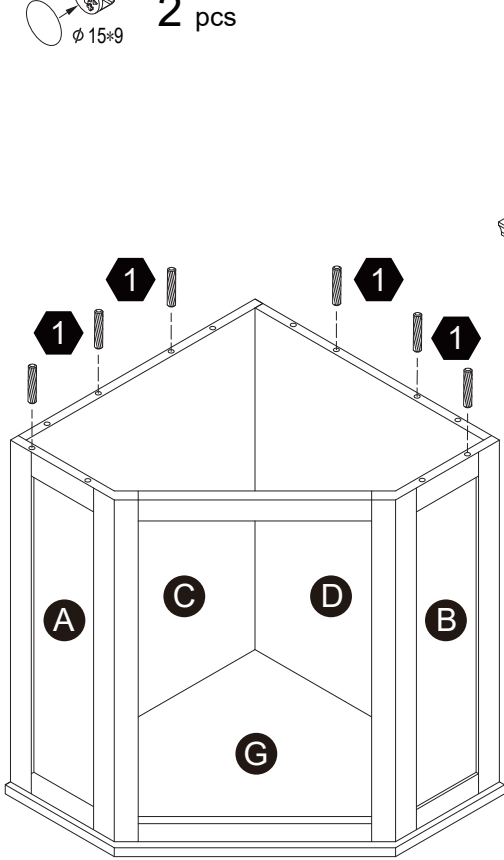

Step 5

5



4 pcs

6



1 pc

7

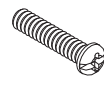

1 pc

8

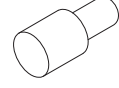

4 pcs

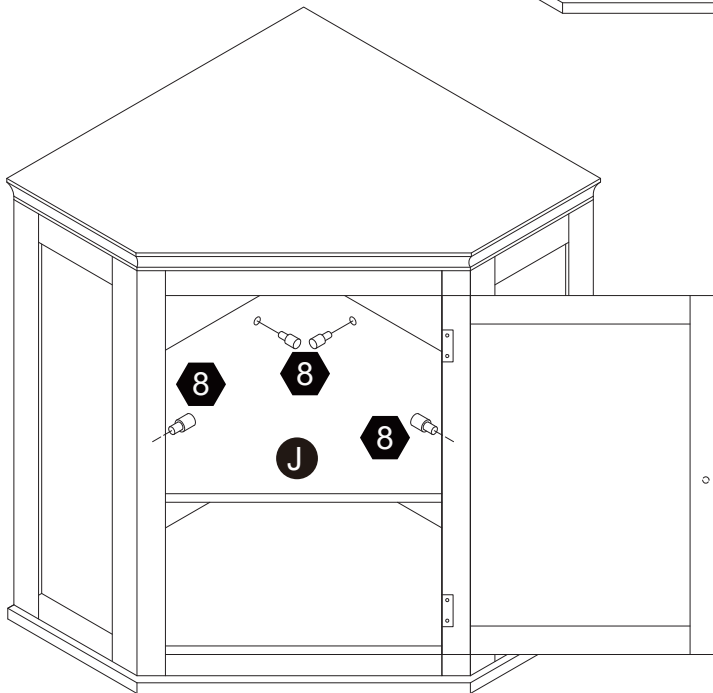
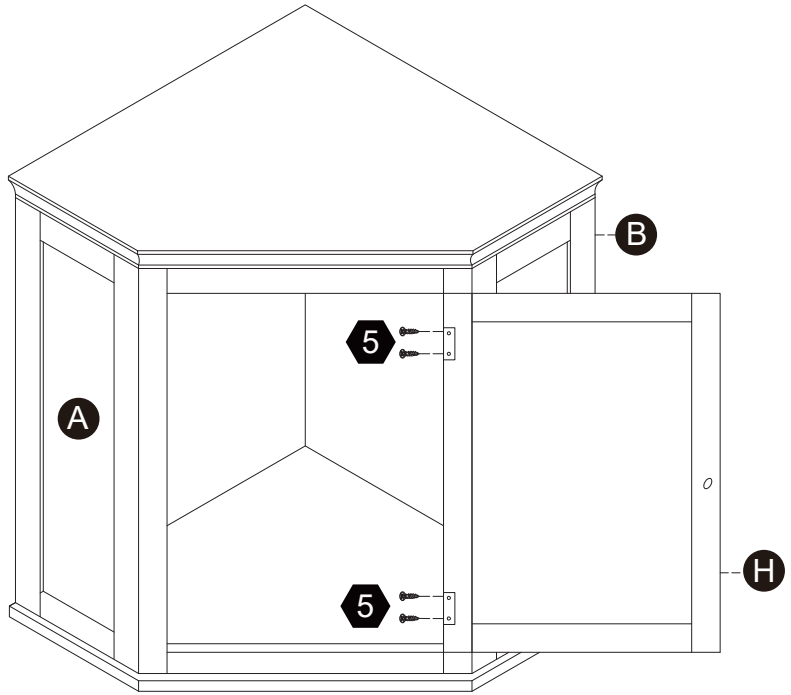
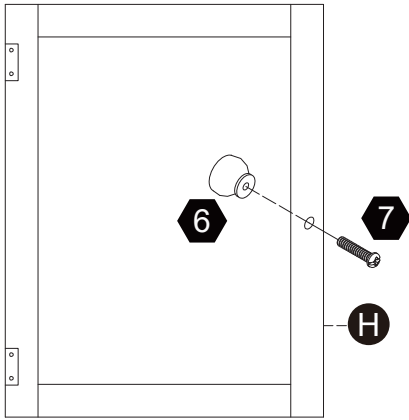

Step 6

10

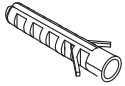

2 pcs

11

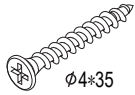

2 pcs

