

Queen Bed

IMPORTANT

Carefully remove all the parts from the carton and place them individually on a soft cloth to prevent scratches or other damage.

Carefully and strictly follow these assembly instructions to ensure a completed product as designed.

Do not use power tools above 8 volts to assemble.

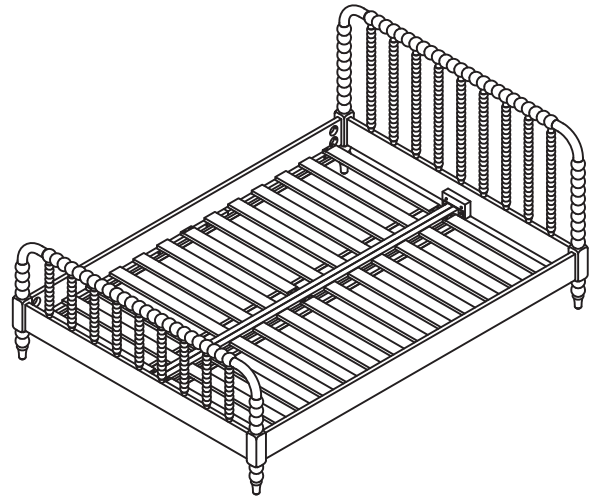

Part List

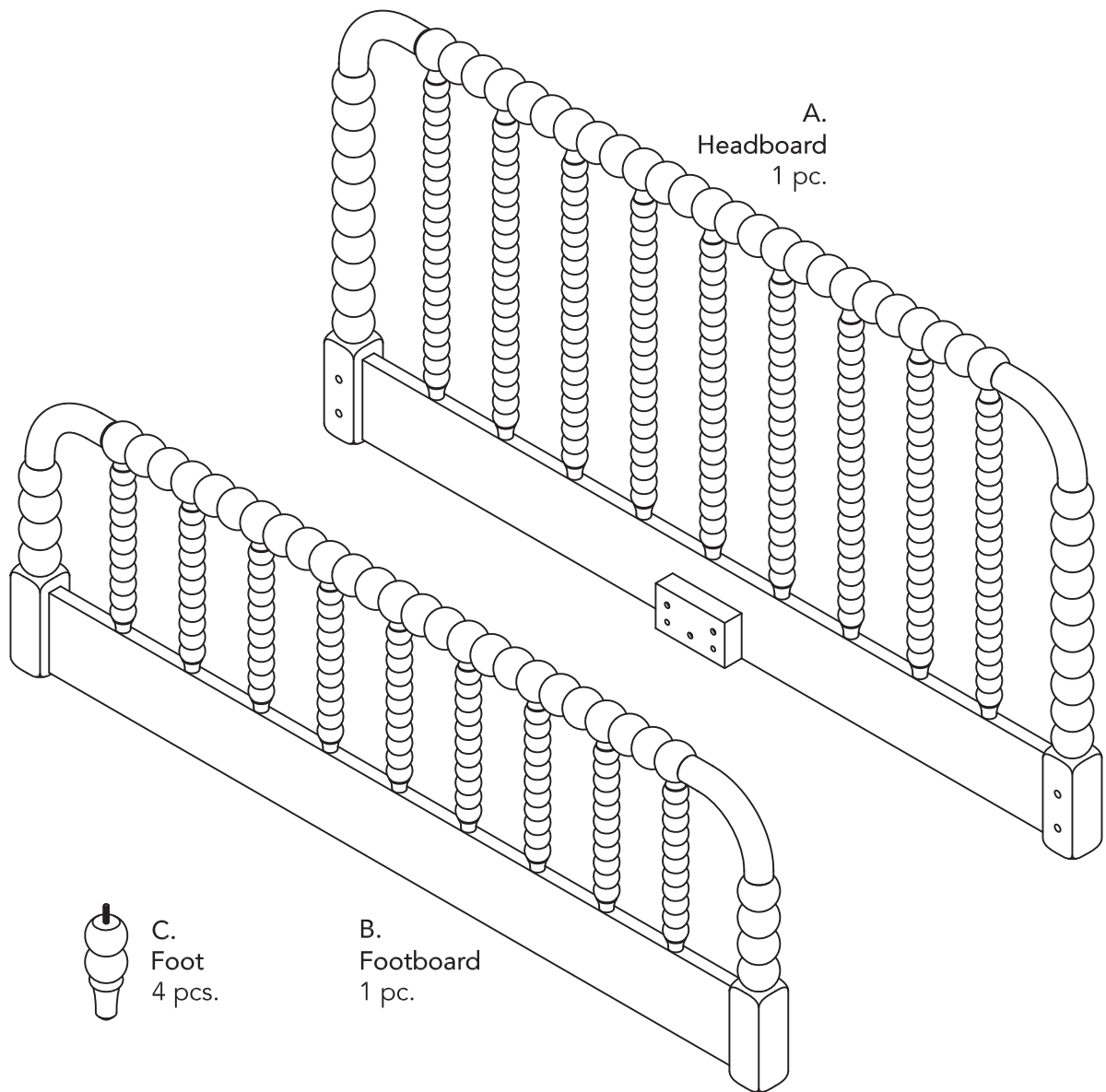

Assembly Instructions 2/2

IMPORTANT

- Use a soft cloth between these parts and the floor.

STEP 1

Attach Feet (C) to Headboard (A) and Footboard (B).

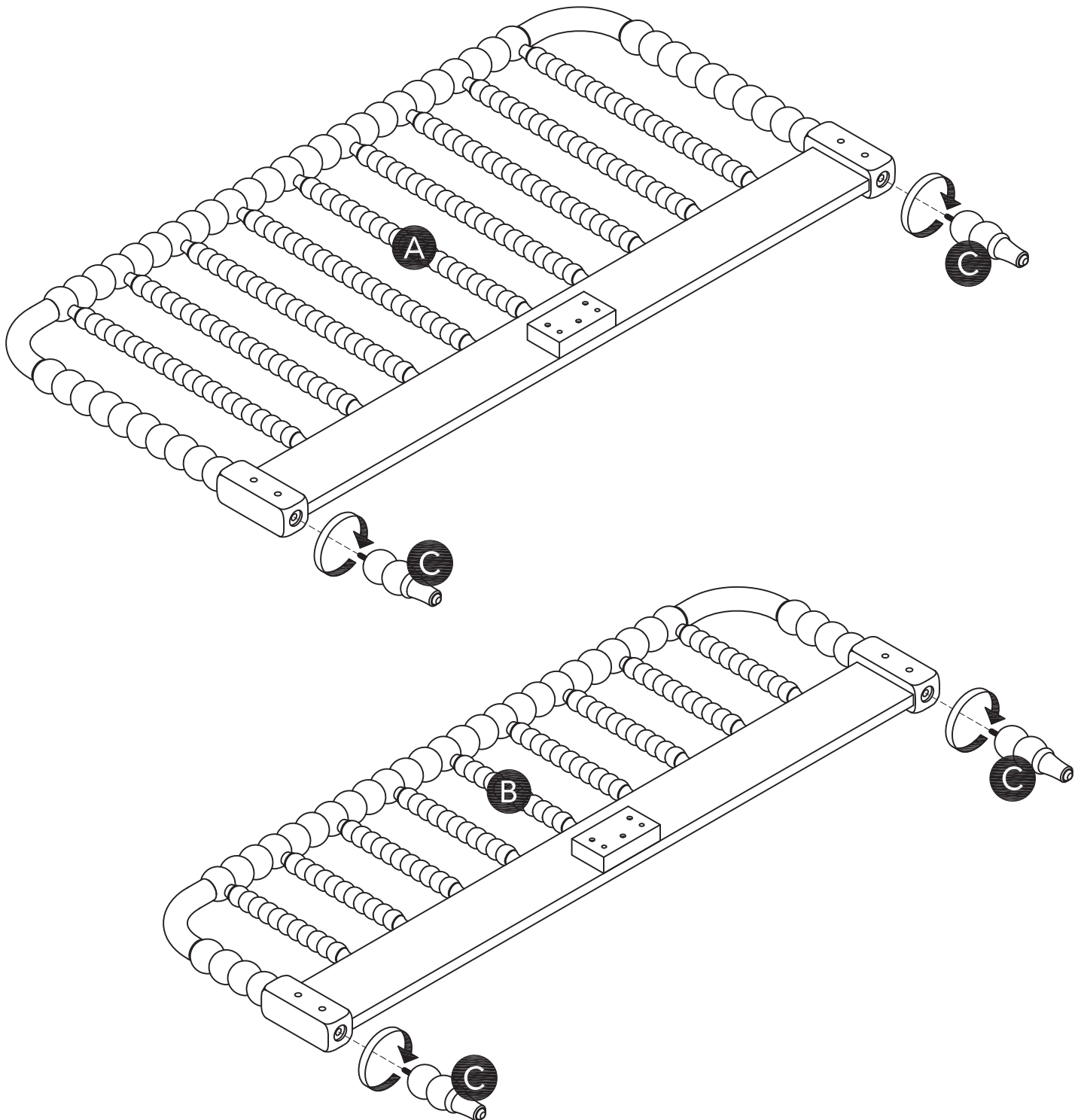

To complete assembly see instructions in carton 5900-502.

Queen Bed

IMPORTANT

Carefully remove all the parts from the carton and place them individually on a soft cloth to prevent scratches or other damage.

Carefully and strictly follow these assembly instructions to ensure a completed product as designed.

Do not use power tools above 8 volts to assemble.

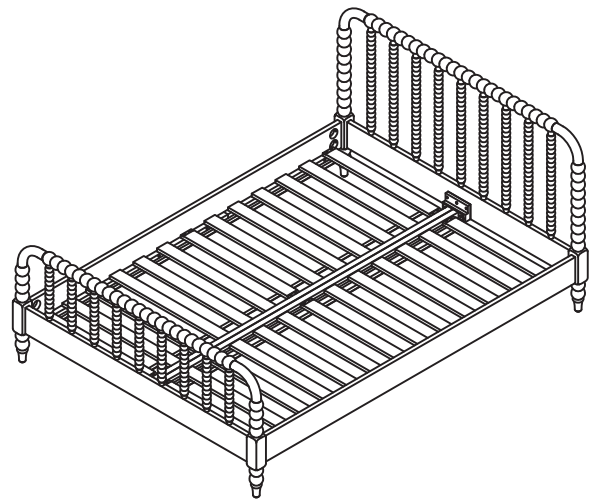

Part List

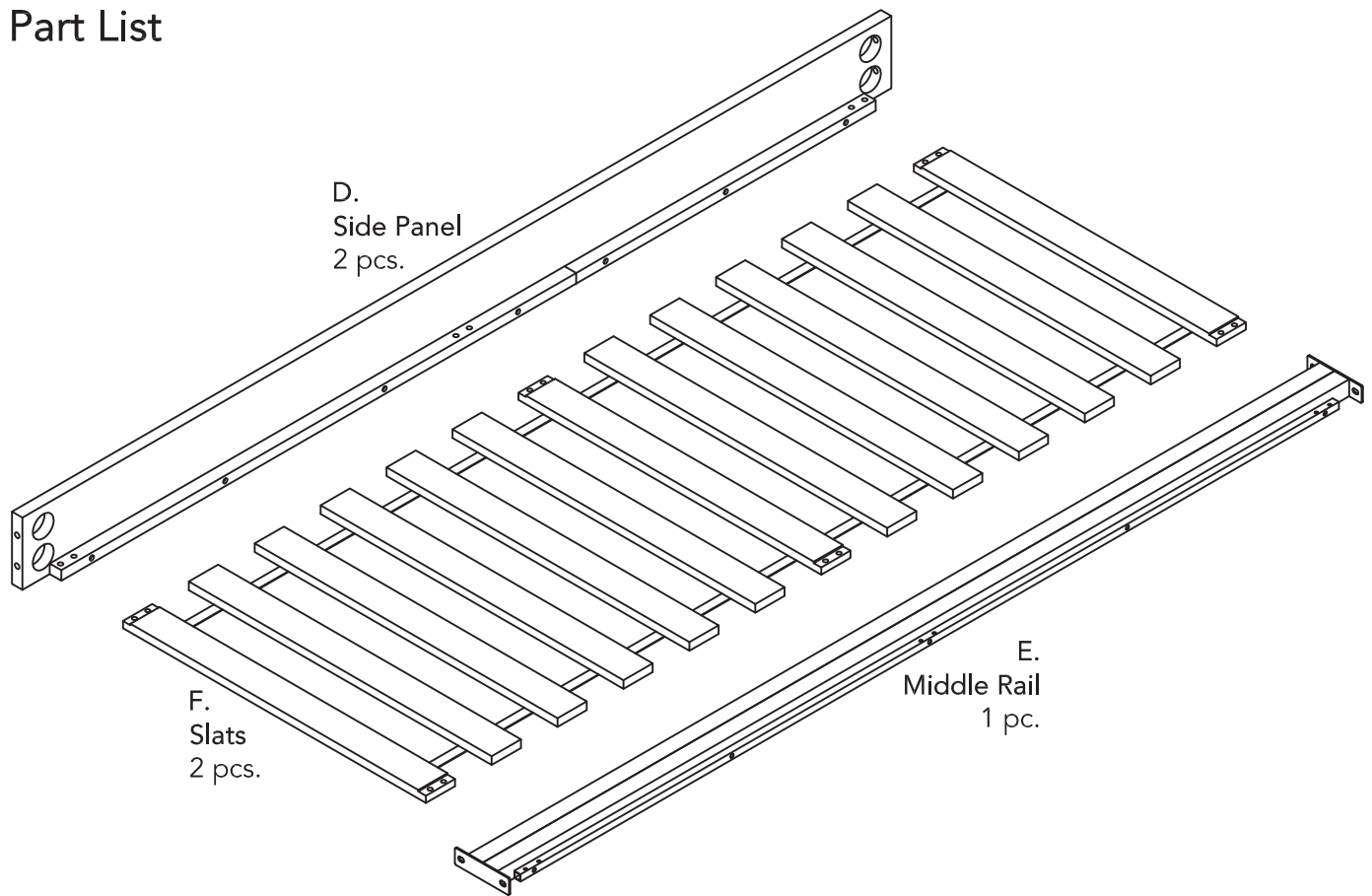

Hardware List



5/16"x3 1/8"
Bolt
8 pcs. (+1 extra)



Square Washer
8 pcs. (+1 extra)



Nut
8 pcs. (+1 extra)



Wrench
1 pc.



M6x25
Head Cap Bolt (long)
24 pcs. (+1 extra)



M6x15
Head Cap Bolt (short)
4 pcs. (+1 extra)



Hex Wrench
1 pc.

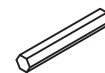

Small
Hex Wrench
1 pc.

Assembly Instructions 2/4

IMPORTANT

- Use a soft cloth between these parts and the floor.
- Do not use power tools above 8 volts to assemble.
- Do not tighten all the bolts until each part is properly assembled.
- Keep Hex Wrench and Wrench as the bolts and nuts may need to be tightened in the future.
- Do not slide bed on floor. To move assembled bed requires two people. Remove any bedding, then lift and carry bed.

Follow instructions in carton 5900-501 first, then proceed with Step 2.

STEP 2

Insert Bolts into pre-drilled holes in Headboard and Footboard, then tighten.

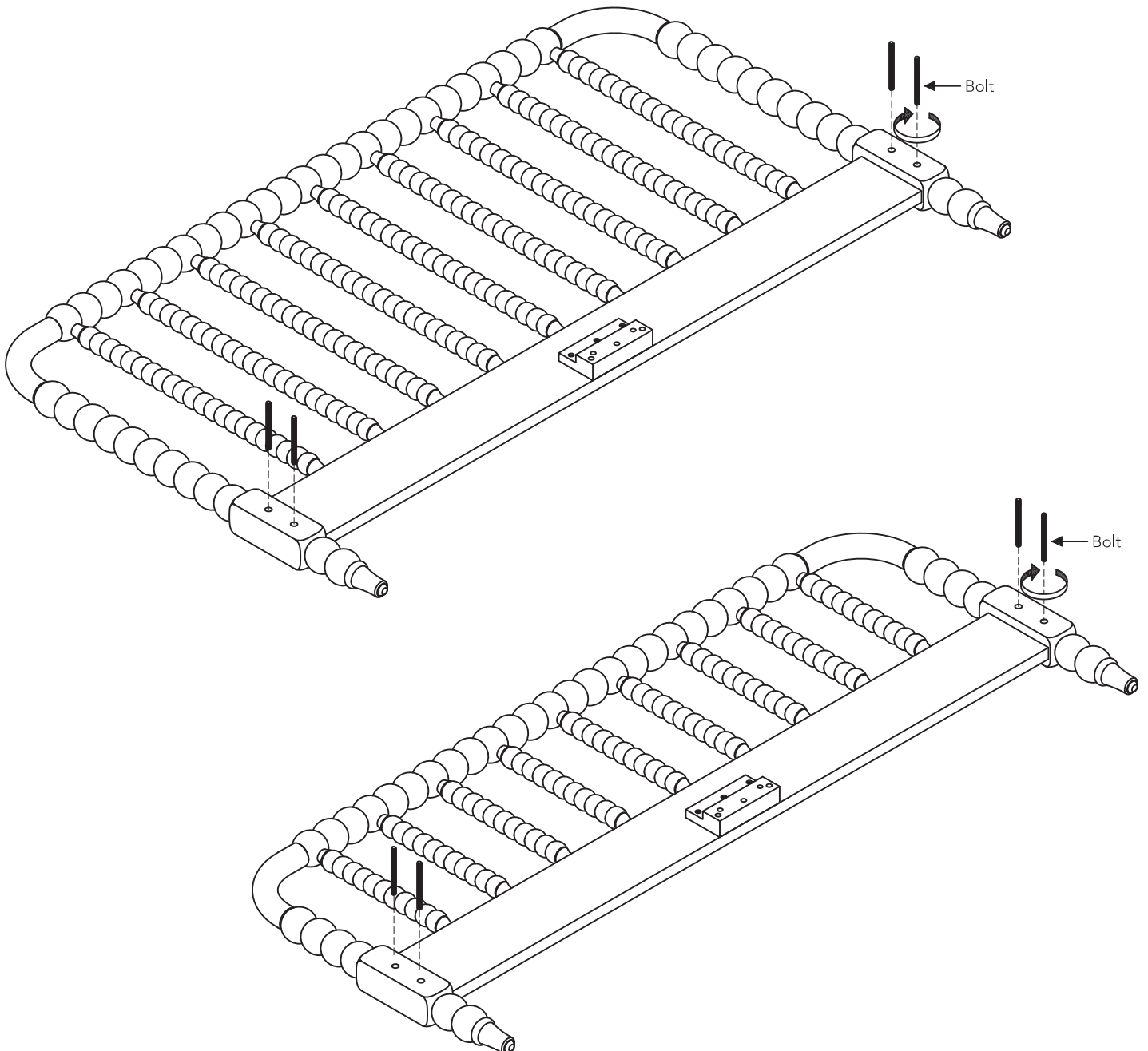

Assembly Instructions 3/4

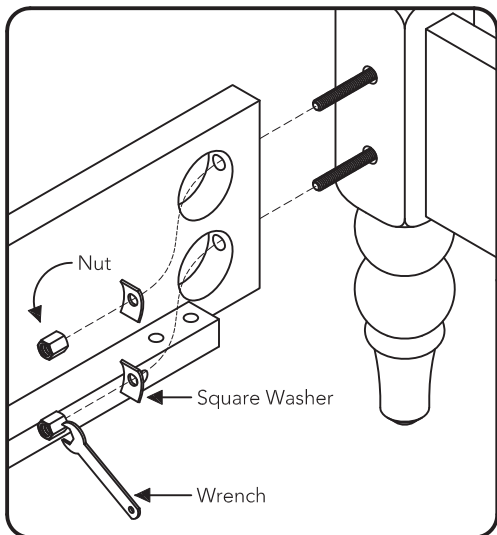
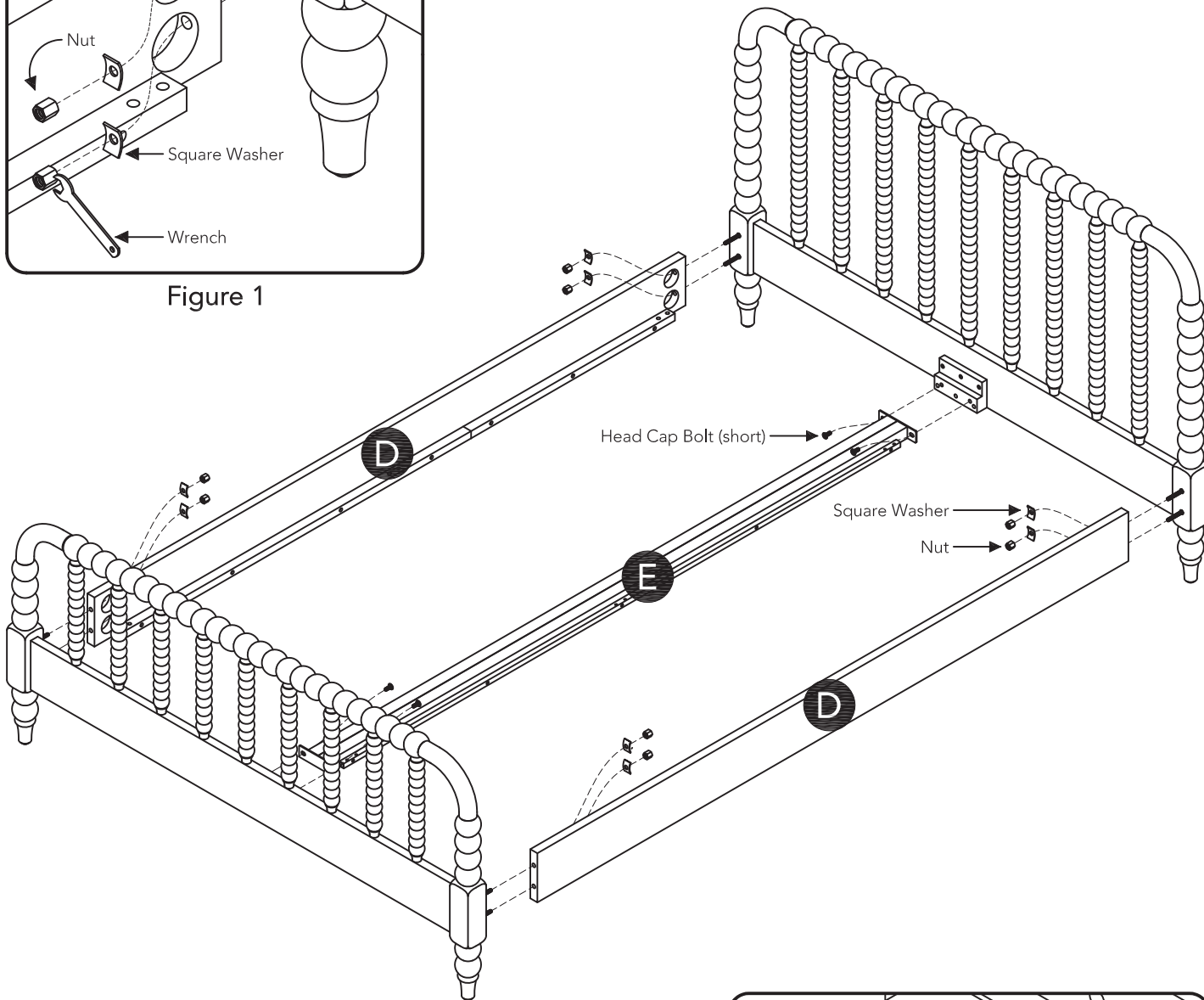

Figure 1



STEP 3

Attach Side Panels (D) to Headboard with Square Washers and Nuts.

Attach Middle Rail (E) to unit with Head Cap Bolts (short).

Attach unit to Footboard with Square Washers, Nuts and Head Cap Bolts (short).

Tighten Nuts with Wrench. (See Figure 1)

Tighten Head Cap Bolts (short) with Hex Wrench. (See Figure 2)

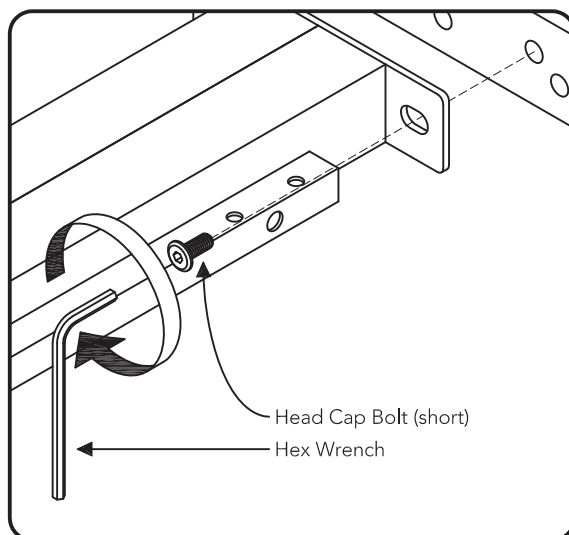
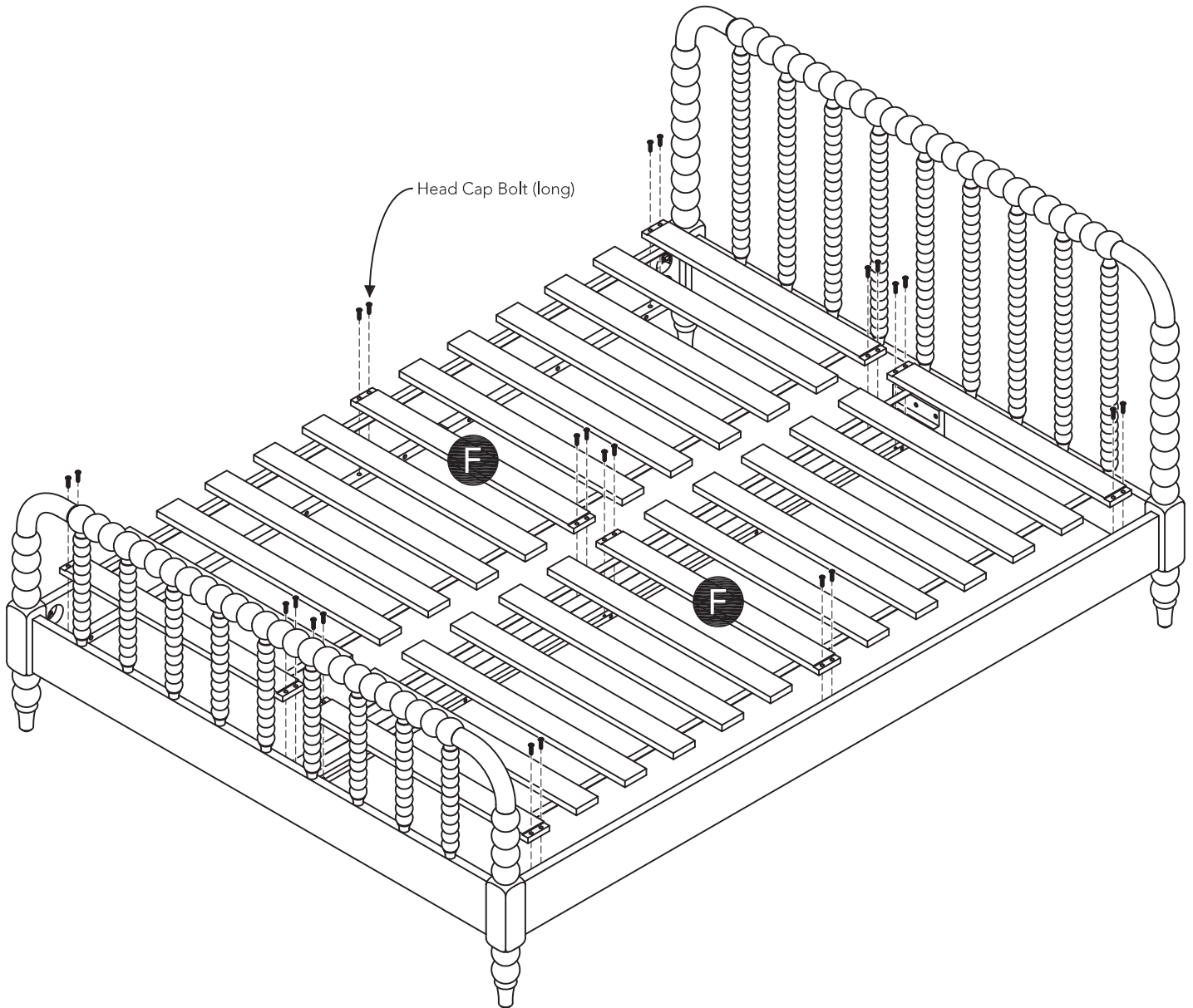

Figure 2

Assembly Instructions 4/4



STEP 4

Attach Slats (F) to unit with Head Cap Bolts (long).

Tighten all bolts with Hex Wrench.

Note: Do not slide bed on floor. To move assembled bed requires two people.
Remove any bedding, then lift and carry bed.

CARE INSTRUCTIONS

NEVER

allow liquids to remain on furniture.
Absorption causes parts to warp
and split and finishes to delaminate.

NEVER

use glass cleaners on
finished furniture. Ammonia
chemically attacks the finish.



Do not use power tools
above 8 volts to assemble.

**PREVENT
CRACKING**



Do not place
in direct sunlight.

**PREVENT
FADING**



Do not write
directly on surface.

**PREVENT
MARKING**



Do not place hot
objects on surface.

**PREVENT
FINISH DAMAGE**



Do not use rubber
based placemats.

**PREVENT
DISCOLORING**



Do not use commercial
waxes and polishes.

**PREVENT
YELLOWING**

CLEAN

with a soft cloth moistened
in lukewarm soap and water.
Buff with a dry clean cloth.



homestyles will provide replacements free of charge for missing or damaged parts within 30 days of purchase. Digital images of the defective parts may be required. If the product was not purchased from an authorized retailer, **homestyles** is under no obligation to provide replacement parts. Parts are not available for fully assembled items nor are parts available for sale. Replacements for missing or damaged parts may be requested via contact info below.

homestyles Customer Service: www.homestylesfurniture.com,
servicedesk@homestylesfurniture.com, 888-680-7460