

USER'S MANUAL

BV8974B

BLUETOOTH® | SINGLE-DIN DVD/MP3/CD AM/FM RECEIVER

BOSS[®]
AUDIO SYSTEMS

BOSS Audio Systems
3451 Lunar Court • Oxnard, CA 93030
www.bossaudio.com | 805.322.8794
tech support: www.bossaudio.com/support/technical-support



0616

iPod® and iPhone® are trademarks of Apple, Inc. registered in the U.S. and other countries.
BOSS Audio Systems is not affiliated with Apple, Inc.
The Bluetooth® word mark and logos are registered trademarks owned by Bluetooth SIG, Inc. and any use of such marks by BOSS Audio Systems is under license. Other trademarks and trade names are those of their respective owners.

USER'S MANUAL

BV8974B

BLUETOOTH[®]
SINGLE-DIN DVD/MP3/CD AM/FM
RECEIVER

FEATURING MOTORIZED 7" (178mm) WIDESCREEN TOUCHSCREEN
DIGITAL TFT LCD MONITOR



BOSS[®]
AUDIO SYSTEMS

**To ensure safety while driving
and to comply with laws,
drivers should not watch video or
operate the video device while driving.**

Content

Precaution	2	Automatic Memory Storing &	
Safety Information	3	Program Scanning.....	19
Disc Note	4	Media Operation.....	20
Installation	5	Basic Operation	21
Electric Connection	9	Selecting Play Mode	21
Remote Control	10	On-Screen Display Function	22
Basic Operation	13	Digital Video Special Function	24
Main Menu Operation.....	13	Multi-Subtitle Language function.....	24
Setting animation.....	13	Multi-audio language Function.....	24
Setting disc.....	13	Multi-angle Function.....	24
Setting radio.....	14	Title menu function	24
Setting BT.....	14	A-B Repeat function.....	25
Setting wallpaper.....	14	Program function.....	25
Version about.....	14	Step function.....	25
Setting time.....	15	Slow speed function.....	25
Setting audio mode.....	15	BT Operation	26
Setting video mode.....	15	AUX Operation	29
Setting illumination color.....	15	AV Operation	30
TFT display calibration.	15	USB Operation	30
Rear View Camera	15	Card Operation	31
Control Panel	16	SWC Operation	32
Unit keys	16	Parental Control	33
Radio Operation	18	Region Code	34
Listening to the radio	18	Specification	35
Storing and Listening to a memory		Troubleshooting	36
station	18		

Precaution

THANK YOU FOR PURCHASING A BOSS AUDIO MULTIMEDIA PLAYER .

Before operating the unit, read this manual thoroughly and keep it handy for future reference .

To avoid injury or accident , read the following precautions before installing and operating the unit .

ON INSTALLATION

- DO NOT install any receiver in locations where;
 - it may obstruct the steering wheel and gearshift lever operations, as this may result in a traffic accident.
 - it may obstruct the operation of safety devices such as air bags, as this may result in a fatal accident.
 - it may obstruct visibility.
- DO NOT operate any receiver while manipulating the steering wheel, as this may result in a traffic accident.
- The driver must not watch the monitor while driving.
- IF THE DRIVER watches the monitor while driving, it may lead to carelessness and cause an accident.
- IF YOU NEED to operate the receive while driving, be sure to look ahead carefully or you may be involved in a traffic accident.
- IF THE PARKING BRAKE is not engaged. “ ParkingBrake ” flashes on the monitor, and no playback picture will be shown.
 - This warning appears only when the parking brake wire is connected to the parking brake system built in the car (refer to the electric connection)

ABOUT THE LIQUID CRYSTAL DISPLAY (LCD) PANEL

Do not press hard on the LCD panel. Doing so can distort the picture or cause a malfunction . The picture may become unclear , or the LCD panel may be damaged .

NOTES ON CLEANING

- Clean the LCD panel with a slightly damp soft cloth.
- Do not use solvents such as benzine, thinner, commercially available cleaners or antistatic spray .
- Do not use alcohol to clean the screen .

If your car was parked in a cold or hot place, the picture may not be clear . The monitor is not damaged . The picture will become clear the temperature in your car becomes normal .

Safety Information

CAUTION:

THIS DIGITAL VIDEO PLAYER IS A CLASS I LASER PRODUCT. HOWEVER THIS DIGITAL VIDEO PLAYER USES A VISIBLE/INVISIBLE LASER BEAM WHICH COULD CAUSE .

HAZARDOUS RADIATION EXPOSURE IF DIRECTED. BE SURE TO OPERATE THE DIGITAL VIDEO PLAYER CORRECTLY AS INSTRUCTED.

USE OF CONTROLS OR ADJUSTMENTS OR PERFORMANCE OF PROCEDURES OTHER THAN THOSE SPECIFIED HEREIN MAY RESULT IN HAZARDOUS RADIATION EXPOSURE. DO NOT OPEN COVERS AND DO NOT REPAIR YOURSELF. REFER SERVICING TO QUALIFIED PERSONNEL.

WARNING:

TO REDUCE THE RISK OF FIRE OR ELECTRIC SHOCK, DO NOT EXPOSE THIS EQUIPMENT TO RAIN OR MOISTURE.

TO REDUCE THE RISK OF FIRE OR ELECTRIC SHOCK, AND ANNOYING INTERFERENCE, USE ONLY THE RECOMMENDED ACCESSORIES.

THIS DEVICE IS INTENDED FOR CONTINUOUS OPERATION.

This product incorporates copyright protection technology that is protected by method claims of certain U.S. Patents and other intellectual property rights owned by Macrovision Corporation and other rights owners. Use of this copyright protection technology must be authorized by Macro vision Corporation, and is intended for home and other limited viewing uses only unless otherwise authorized by Macrovision Corporation. Reverse engineering or disassembly is prohibited.

REGION MANAGEMENT INFORMATION:

This Digital Video Player is designed and manufactured to respond to the Region Management Information that is recorded on a Digital Video disc. If the Region number described on the Digital Video disc does not correspond to the Region number of this Digital Video Player, this Digital Video Player cannot play this disc.

Disc Note

Disc formats supported by this player

Digital Video	Audio and Video Disc size 12 cm
VCD	Audio and Video Disc size 12 cm
CD	Audio Disc size 12 cm
MP3	Audio Disc size 12 cm

Discs which cannot be played with this player

- Digital Video-RAM
- CDV
- CDG

Handling and Cleaning

- Dirt, dust, scratches and warping disc will cause misoperation.
- Do not place stickers or make scratches on discs.
- Do not warp discs.
- A disc should always be kept in its case when not in use to prevent from damaging.
- Do not place discs in the following places:
 1. Direct sunlight
 2. Dirty, dusty and damp areas
 3. Near car heaters
 4. On the seats or dashboard

Disc Cleaning

Use a dry soft cloth to wipe the surface. If the disc is quite dirty, use a soft cloth slightly moistured with isopropyl (rubbing) alcohol. Never use solvents such as benzine, thinner or conventional record cleaners as they may mar the surface of the disc.

Note:

A disc may become somewhat scratched (although not enough to make it

unusable) depending on your handle it and conditions in the usage environment. Note these scratches are not an indication of any problem with the player.

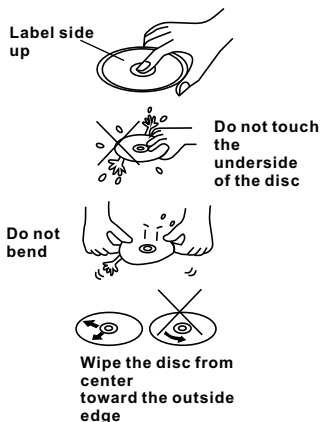

Preparing New Discs with Rough Spots

A new disc may have rough edges on its inside and outside edges. If a disc with rough edges is used, the proper setting will not be performed and the player will not play the disc. Therefore, remove the rough edges in advance by using a ball point pen or pencil as shown on the right. To remove the rough edges, press the side of the pen or pencil against the inside and outside edges of the disc.

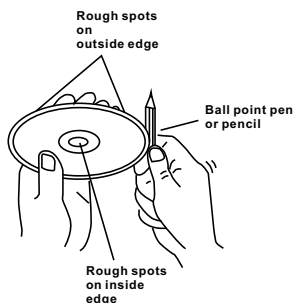

Installation

NOTES:

1. Choose the mounting location where the unit will not interfere with the normal driving function of the driver.
2. Before finally installing the unit, connect the wiring temporarily and make sure it is all connected up properly and the unit and the system work properly.
3. Use only the parts included with the unit to ensure proper installation. The use of unauthorized parts can cause malfunctions.
4. Consult with your nearest dealer if installation requires the drilling of holes or other modifications of the vehicle.
5. Install the unit where it does not get in the driver's way and cannot injure the passenger if there is a sudden stop, like an emergency stop.
6. Avoid installing the unit where it would be subject to high temperature, such as from direct sunlight, or from hot air, from the heater, or where it would be subject to dust, dirt or excessive vibration.
7. If installation angle exceeds 30° from horizontal, the unit might not give its optimum performance.

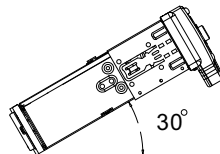

DIN FRONT/REAR-MOUNT

This unit can be properly installed either from "Front"(conventional DIN Front-mount) or "Rear"(DIN Rear-mount installation, utilizing threaded screw holes at the sides of the unit chassis). For details, refer to the following illustrated installation methods.

Removing the unit

1

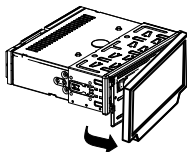

1. Press the **REL** button to release the front panel .

2

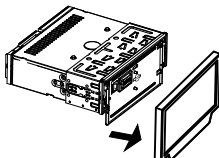

2. Remove the control panel .

Installation

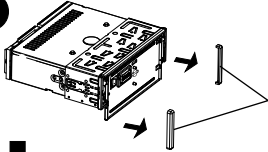
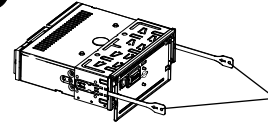
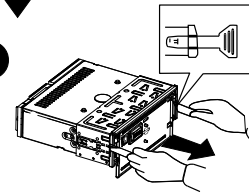
- 3**  3. Remove the PLASTIC COVER of the both sides away
- 4**  4. Insert the two KEY PLAT into the grooves at both sides of the unit as shown in figure until they click .
- 5**  5. Pulling the levers makes it possible to remove the unit from the dashboard .

Installation the unit

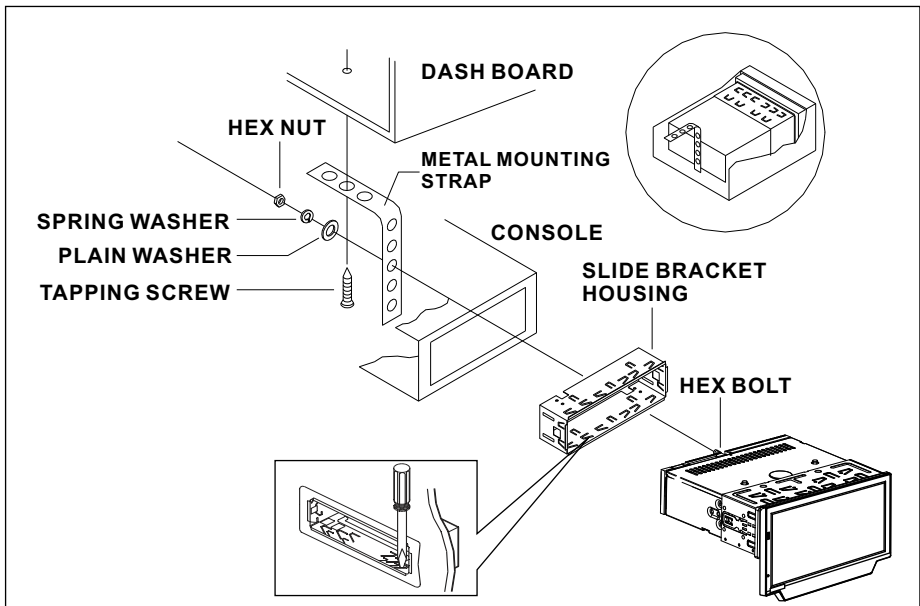

Installation

How To Remove And Install The Front Panel

When detaching or attaching the control panel, be careful not to damage the connectors on the back of the control panel and on the panel holder.

Detaching Control Panel

Before detaching the control panel, be sure to turn off the power.

1). Press the "REL" release button and the left hand side of front panel will release.

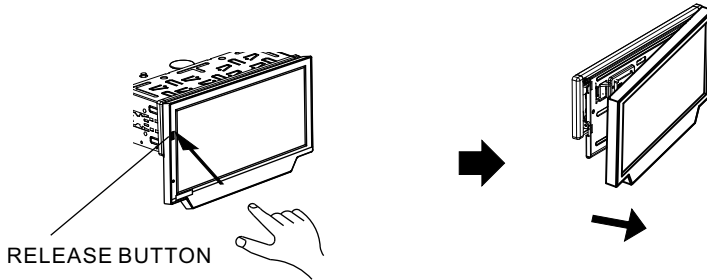

2). Pull-off the front panel and keep the front panel into the case .

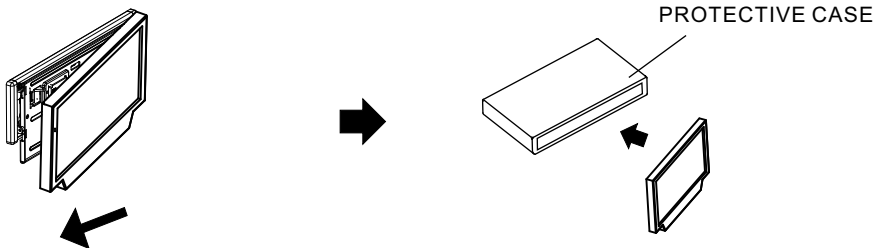

Attaching Control Panel

1). First insert the right hand side of the front panel into the hollow of the unit .

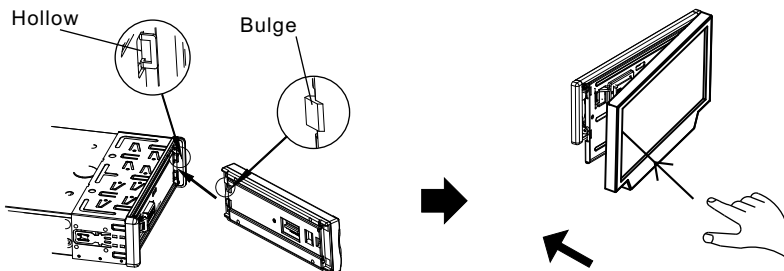

(NOTE : the "bulge" point on the panel must be attached into the hollow of the unit .)

2). Gently push the left hand side of the front panel until you feel a " Click" .



Installation

CHANGING THE CONTROL PANEL ANGLE

When you want to change the viewing angle of the operating unit to play, you can touch the  section on touch screen (or press the  button on the remote) repeatedly to select the desired angle as follows:

ANGLE 1 - ANGLE 2 - ANGLE 3 - ANGLE 4 - ANGLE 1 .

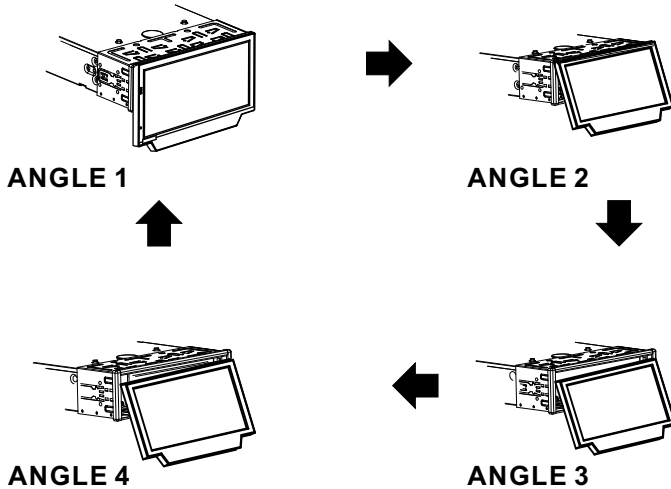

Caution:

Do not insert your finger behind the control panel.

Electric Connection

WIRING CONNECTION

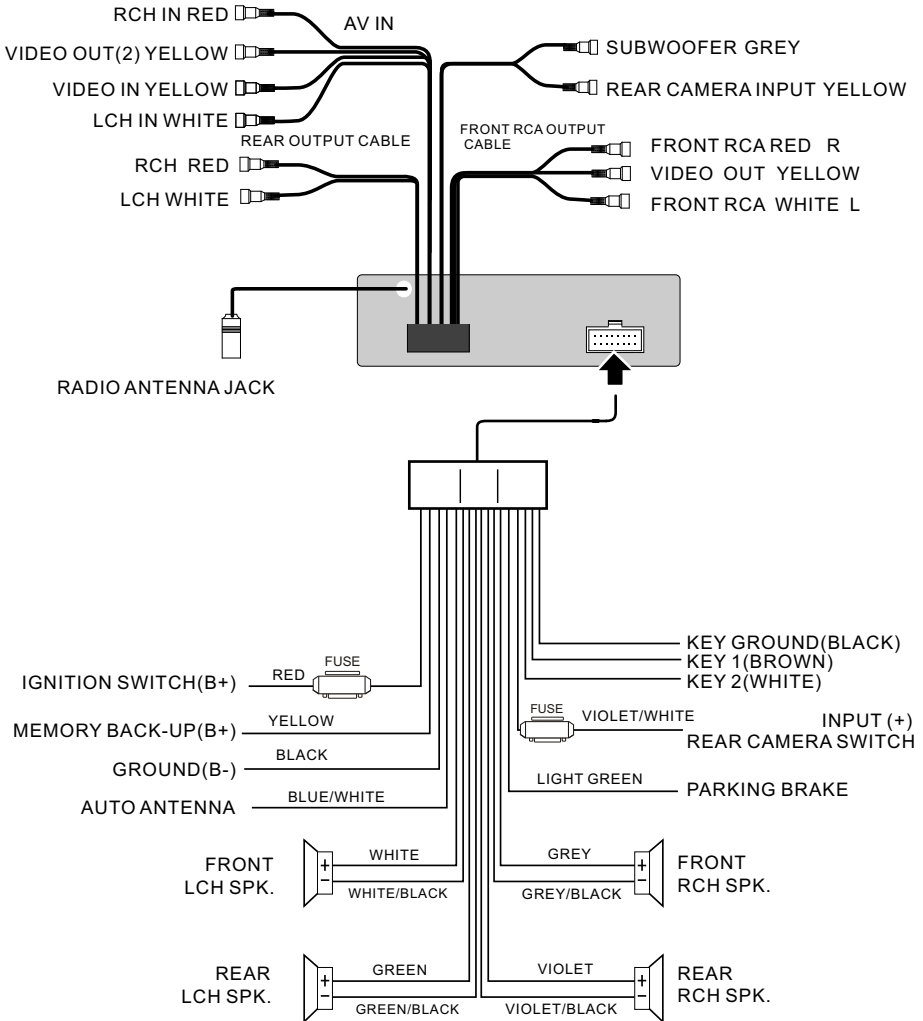

Remote Control

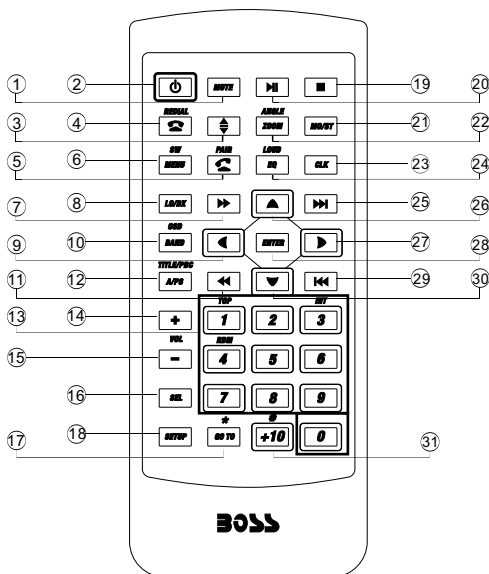

Ref #	Button	Function
1	MUTE	Press this button to turn off the audio. Press again to restore the sound to its prior volume level.
2	POWER	Press this button to turn the unit ON , press and hold to turn the unit OFF.
3	◆	Press it button to change the viewing angle of the operate unit .
4	REDIAL	Press it to use the BT , refer to see BT operation
5	PAIR	Press it to use the BT , refer to see BT operation
6	SW/ MENU	Press this button briefly to display the root level directory of a Digital Video disc. Press and hold this button to switch SWF FREQ between 80HZ, 120HZ and 160HZ.
7&11	▶▶/◀◀	In Disc Playback mode, press for fast forward playback. In DISC mode, press it to reverse rapidly
8	LOCAL/ DISTANT	In Radio mode, press this button to change the radio reception sensitivity in stations are near or far.
9/26/ 27/30	◀/▼/▶/▲	Press to navigate the various menus present in the product.
10	OSD/ BAND	In Radio mode, press this button repeatedly to switch between the five radio bands: FM1 > FM2 > FM3 > AM1(MW1) > AM2 (MW2) . In Disc Playback modes, Press this button to see information about the disc currently in play.

Remote Control

Ref #	Button	Function
12	PBC/ TITLE/ A/PS	In Digital Video play mode, for TITLE menu ; in VCD play mode, press this button to create a PBC (Playback Control) menu; please see the Title Menu function. In Radio mode, press and hold this button to start the Auto-Program mode, during which the tuner will scan for all strong stations and assign them to the radio preset buttons.
13	0-9	Use to input numerical values during programming, with the GOTO button, or to directly select a track to play .
14&15	VOL+/-	Use these controls to adjust the volume level.
16	SEL	Press the SEL to switch between BASS, TREBLE, BALANCE, FADE, SWF VOL and SWF FREQ. After switching on the desired mode above, rotate VOL knob or press VOL+/VOL- buttons to set it.
17	GOTO/ ✳	Press it button to begin playback at a moment in the program you designate. Use number buttons to enter the data that is needed. In BT menu, it serves as the asterisk button on your mobile handset.
18	SETUP	Press this button to open the SETUP menu.
19	STOP	Press once to pause playback. Press PLAY/PAUSE to resume playback. Please note: if you press STOP twice, playback will start at the beginning of the disc.
20	PLAY/ PAUSE	In Disc Playback mode, press to pause playback. Press again to start where playback stopped.
21	MO/ST	In Radio mode, press this button to change between Mono and Stereo reception modes (when a station is weak, sometimes switching to Mono will improve sound quality).
22	ANGLE/ ZOOM	For Digital Video discs which have alternate viewing angles encoded, when you see the "angle mark" symbol advising you that these angles are available, longer press this button to see them. Shortly press it button to increase the picture in size .
23	CLK	Press it briefly to view the clock time .
24	LOUD/ EQ	Press repeatedly to cycle through the different equalizer curve presets you may wish to use for enhanced listening. Press longer to switch the LOUDNESS function between LOW, MIDDLE, HIGH and OFF.
25&29	▶▶ / ◀◀	Press these buttons to skip ahead or back one track.
28	ENTER	This button is used to confirm selections and settings within many of the menus in the OSD system.
31	+10/#	This button is used with the other number buttons for use with two-digit number entries. In BT menu, it serves as the hash button on your mobile handset.

Remote Control

Preparing the Remote Control

Inserting the Battery

1. First push to inside as the direction indicated by the arrow (See ①) And then Remove the battery holder as the direction indicated by the arrow (See ②).
2. Replace the battery Set a new battery property with (+)side up as illustrated (See ③).
3. Insert the battery holder. Push in the holder to the original position(See ④).

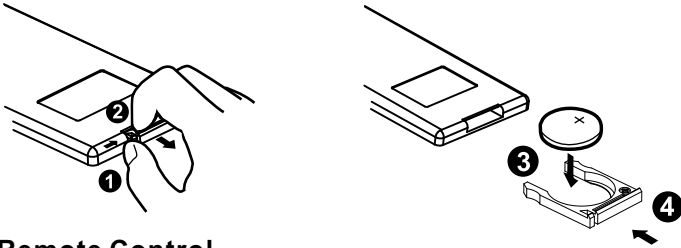

Using the Remote Control

Face the remote control towards the player front face IR mark (remote control signal receiver).



Operation angle: About ± 30 degree in each the direction of the front of the IR mark.

Note :

The lithium cell in the battery compartment of remote control has been secured for transport with a plastic . Before initial use please remove this plastic so that the remote control is ready for operation .





Basic Operation

Main Menu Operation

In many modes, touch the  icon or touch the  range to enter the main menu, the message like following as below.



1. POWER icon
In any modes, touch the POWER icon to switch the unit off .
2. UP/DOWN icon
Touch this icon to adjust the angle of the monitor upward or downward until your desired angle .
3. EJECT icon
Touch to allow for inserting or ejecting disc.
4. When the unit is power on, tap to turn off the display and the unit still work, tap anywhere of the display to turn on the display again.
5. SETUP icon
Touch to enter the SETTING mode, the message will display as follow :

Touch the “  ” section on the setting menu, touch the “  /  ” ranges to select the adjustment item, Touch the “  ” icon to return to the previous playback .

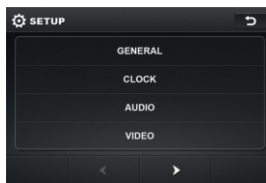

Setup interface 1

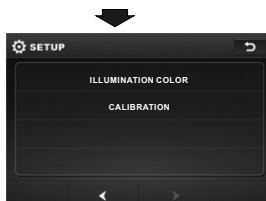

Setup interface 2

ADJUSTABLE ITEMS:

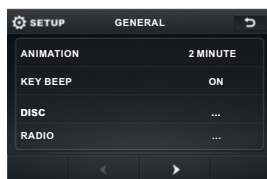

General setup interface1

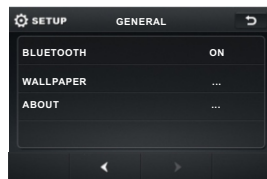

General setup interface2

ANIMATION

In **RADIO** mode, you can change the playing time of animation among of “OFF, 10S, 30S, 1M,90S, 2M, 3M and 4M ”.

Note:

Please set the playing time of the animation to “ **10S** ” for the first, when you turn the unit on .

KEY BEEP : ON or OFF.

Basic Operation

Disc setup as follow:

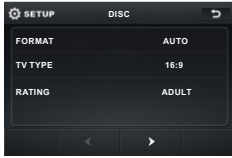

FORMAT

This player is capable of playing discs recorded in either PAL or NTSC formats. Make the selection based on whether you are connecting the unit to a PAL TV or an NTSC TV. You can also set the unit to AUTO (auto select). The disadvantage to autoselect is that each time you turn the unit on it checks to see what kind of monitor is connected, which causes a small delay and some flickering of the display image which you may find unpleasant.

TV TYPE

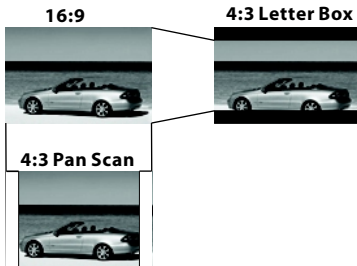

This is to select the appropriate TV aspect (4:3 or 16:9) according to the connected TV set.

Normal/PS (For 4:3 TV)

Played back in the PAN & SCAN style. (If connected to wide-screen TV, the left and right edges are cut off.)

Normal/LB (For 4:3 TV)

Played back in LETTER BOX style. (If connected to wide-screen TV, black bands appear at top and bottom of the screen.)

Wide (For 16:9 TV)

Select when a wide-screen TV set is connected.

RATING

Select to turn Parental Control on or off. The factory default password is **0000**. (The password must be used to make

changes to the Parental Control menu below .)

Key in **"0000"** and then turn to rating then you can setting as follow:

**KID SAFE -> G -> PG -> PG-13
-> PG R -> R -> NC-17 -> ADULT**

RADIO

ST/MONO: touch to select stereo or mono.

LOCAL: touch to select local or distant.

REGION: touch to select radio frequency.

BT

Touch to select BT function on or off.

WALLPAPER

Touch to select wallpaper .

ABOUT

Touch to show the version information.

CLOCK SETUP

Touch the CLOCK to adjust the time and time format.

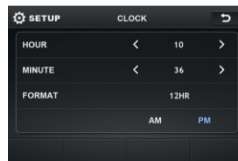

[clock setup interface](#)

AUDIO SETUP

Touch the audio to turn to audio quality adjustment.

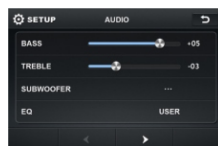

[audio setup interface 1](#)

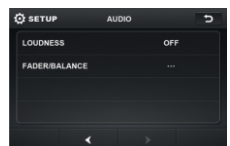

[audio setup interface 2](#)

Basic Operation

TREBLE: -7 to +7
Adjust treble level .

BASS: -7 to +7
Adjust bass level .

SUBWOOFER: touch to adjust subwoofer volume and frequency.

EQ: touch to select audio mode as follow:
USER -> JAZZ -> CLASSIC -> POP -> ROCK

LOUDNESS: touch to select loudness effect as :OFF -> LOW -> MID -> HIGH

FADER/BALANCE:
BALANCE: R 0-10 to L 0-10

Adjust sound balance between left and right speakers .

FADE: F 0-10 to R 0-10
Adjust sound balance between front and rear speakers .

VIDEO SETUP

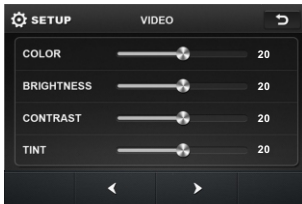

Video setup interface

COLOR: 0 to 40
Adjust the color for the picture-lighter or darker.

BRIGHTNESS: 0 to 40
Adjust if the picture is too bright or too dark.

CONTRAST: 0 to 40
Adjust the contrast of the bright and dark portion.

TINT: 0 to 40
Adjust the tint if the human skin color is unnatural.

-Adjustable when “NTSC “ is selected for “NTSC/PAL “ .

ILLUMINATION COLOR

Touch to select the backlight for all buttons. Tap auto icon the backlight change automatically.

CALIBRATION

Touch the arrow as show to calibration the display.

Reset Factory Settings

RESET button is placed on the housing and must be activated with either a ballpoint pen or thin metal object. The RESET button is to be activated for the following reasons:

- A. Initial installation of the unit when all wiring is completed.
- B. All the function buttons do not operate.
- C. Error symbol on the display.

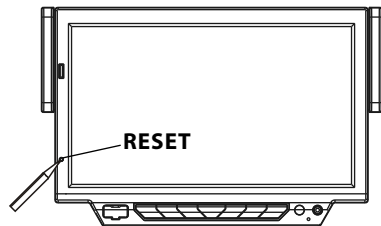

NOTE:
If RESET is selected, all memory data will deleted, please re-adjust .

Rear View Camera

When connecting the rear view camera the mirror image of the rear view is automatically displayed on the monitor when you change the gear to the back position.
(Note: additional monitor can not display the image.)

Control Panel

UNIT KEYS

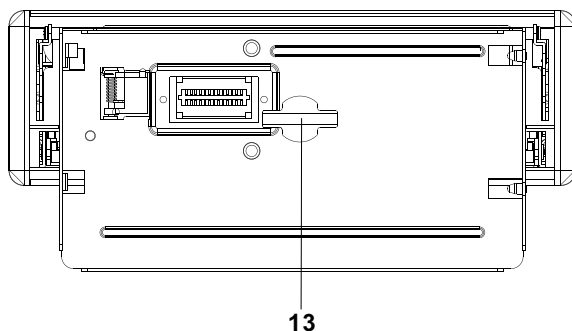
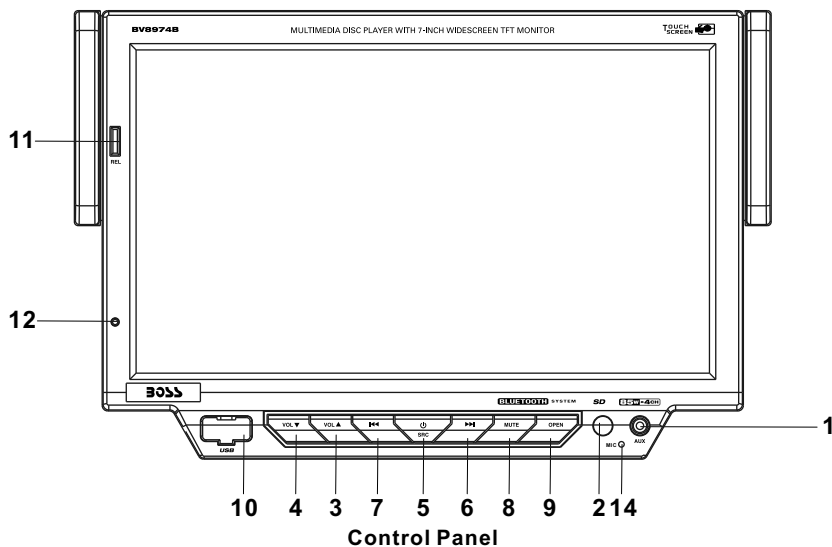

Sliding Plate diagram after removing Control Panel

1. AUXILIARY INPUT JACK

Insert an external device to this AUX jack in order to have audio output of the device through the unit.

2. IR sensor

3&4. VOL+ / VOL- BUTTON

In normal mode, these two buttons are used to increase or decrease the volume. And also used as an UP/DOWN knob when audio or video settings are being adjusted when accessed using the SELECT button.

Control Panel

5. /SRC BUTTON

In power off mode, press it to turn on the unit.

In power on mode, short press it repeatedly to select one mode of the RADIO, DISC, USB, CARD, BT,AUX and AV; long press it to turn off the unit.

6/7. >>| and |<< BUTTONS

In radio mode, long pressing |<< or >>| button can automatically search down or up for an available station beginning from the current frequency; Briefly pressing |<< or >>| button can manually search down or up for a your desired station beginning from the current frequency.

In media mode, pressing |<< or >>| button can play the previous or next track; continuously and long pressing |<< or >>| button can fast backwards or forwards at the following multiple of normal speed: x2, x4, x8, x20.

8. MUTE BUTTON

Press it button to switch of the loudspeakers for a short period. The word MUTE flashes in the display. Press it again to cancel the mute function. This function can also be cancelled by rotating the VOL multifunction button.

9. OPEN BUTTON

To slide the monitor out and stand it up or into the monitor slot, press this button,

10. USB PORT

For information about connecting a USB device, please see USB operation.

11. REL BUTTON

Press it to detachable the front panel.

12. RESET BUTTON

Press this button to return to factory settings.

13. SD CARD SLOT

14. MICROPHONE

Touch Screen Operation

RADIO OPERATION

Listening to Radio

Touch the RADIO ICON in home menu to enter the RADIO mode. In radio mode, tap  icon to adjust the brightness for the display .



Selecting The Frequency Band

Touch the screen of “ **BAND** ” section repeatedly to select the band , the message will show in turn :

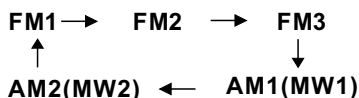



When an FM stereo broadcast is hard to receive

Press **ST/MO** button on the remote control to select the MONO or STEREO mode . (When Stereo mode is activated, the ST symbol will appear .)



Start Searching For a Station

Manual Search

During Radio mode, briefly touch “  ” to increase frequency by one step of channel spacing.

Briefly touch “  ” to decrease frequency by one step of channel spacing.

Automatic Search

During Radio mode, touch and hold (for more than 2 seconds) either “  /  ” ICONS to start search for a radio station automatically.

To tune in strong-signal FM Station only (LO/DX function)

In radio mode, Press LOC button on the remote control or tap  icon to select select LOC/DX mode of Local and Long-distance traffic news.

Storing and Listening to a Memory Station

Setting Memory

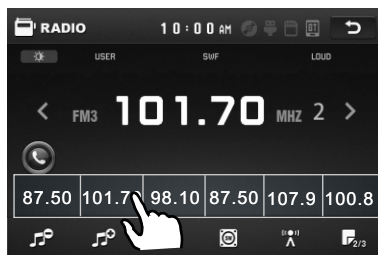

With this system, a total of 30 stations can be stored in the memory of six buttons. Each band stores up to six preset stations. The stations might be FM1, FM2, FM3, AM1(MW1), and AM2(MW2) band.

The operation is as below :

Touch Screen Operation

- Store in Memory

- >Select the frequency band
- >Select the station
- >Press and the station until it show the frequency band your select.

- Retrieve a preset station

Touch the **1-6** ranges briefly to retrieve a station which had been stored in the memory in advance the chose number is shown on display .

Automatic Memory Storing & Program Scanning

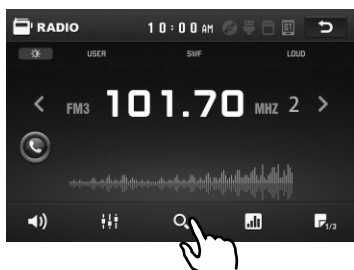

Automatic Preset Setup

In Radio Mode, touch and keep (for more than 2 ' S) the screen of “ **Q** ” range to active automatic station storage. The radio searches within the current frequency band, e.g. Fm3, for the stronger signal level until the search cycle has finished . The six strongest stations are then allocated to the corresponding storage locations . Then the station of the first storage location is set .

Scan Function









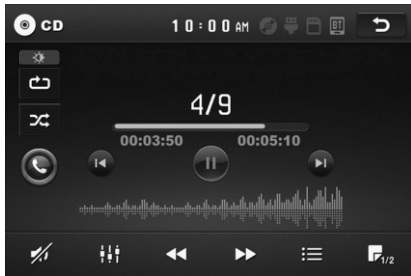



In Radio mode, briefly touch the “ **Q** ” section on the touch screen , the radio briefly plays all the preset stations of the frequency band .



Touch Screen Operation

Media Operation

In audio play mode, the message will display as below :



-  Mute function
-  To select the Equalizer mode
-  Fast forward
-  Fast backward
-  Intro Function
-  To decrease the volume level
-  To increase the volume level
-  Loudness Function
-  Subwoofer Function
-  Play/Pause the playing
-  To skip the next track
-  To skip the previous track
-  Repeat Function







-  Random Function
-  Previous menu
-  Tap to turn to BT PHONE mode.
(after pairing and connecting a mobile phone with BT function).

In audio play mode, tap  icon to adjust the brightness for the display .

The icons for other mode

(The same icon have the same function in each mode)





-  In PHOTO playing ,tap to change the photo direction.
-  ZOOM IN and OUT.
-  For page turning.
-  For page turning.
-  For page turning.
-  For page turning.





Touch Screen Operation

BASIC OPERATION

Pause (still picture)

 Touch the “” section on touch screen during playback will stop play temporary, touch it again to return the normal playback .



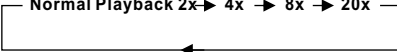

Rapid Forward/Rapid Reverse

 During DISC playback, touch the screen of “ / ” range the speed of rapid forward/reverse changes according to the disc as follow:

Digital Video/VCD/CD/MP3:

Normal Playback 2x → 4x → 8x → 20x



Skipping Track

 During DISC playback, Touch the  /  section on the touch screen to skip to next/back one track.

Note :

For some VCD2.0 disc (PBC-playback control), above these buttons may be unavailable .

Zoom Function

 Touch the button repeatedly, the display show as “**zoom 2, zoom 3, zoom 4 , zoom ½, zoom 1/3, zoom 1/4 , zoom off .**”

Use the direction keys (▲ / ▼ / ◀ / ▶) on remote control to move the enlarged picture .

Note:

when the JPEG disc playback, in normal mode, you can use the cursor buttons to rotate the picture .

Press UP to invert an image .

Press DOWN to mirror an image .

Press LEFT to rotate an image to left .

Press RIGHT to rotate an image to right .

SELECTING PLAY MODES

During the Disc playback, select the “RPT, RDM, INT” to select your favour play mode.

1). REPEAT FUNCTION

FOR Digital Video :

Tap the  icon or press the RPT button on the remote control to select REPEAT mode as follows :

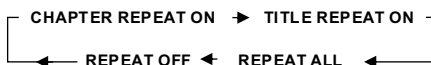

FOR VCD/CD :

Tap the  icon or press the RPT button on the remote control to select REPEAT mode as follows :



FOR MP3 :

Tap the  icon or press the RPT button on the remote control) to select REPEAT mode as follows :

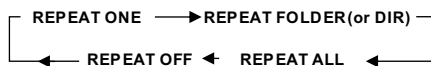

2). INTRO FUNCTION

FOR CD :

Tap the  icon or press the INT button on the remote control to play the previous 10 seconds part of each track/chapter on disc.

(Touch it again to cancel this mode)

Touch Screen Operation

FOR VCD :

Press the **INT** button on the remote control. It display will following menu as below :

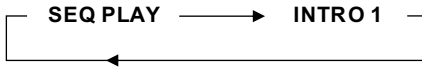

Note: when select the **INTRO** Mode, this player to start to play the previous 15 seconds part of each track/chapter on disc. (Touch it again to cancel this mode .)

FOR Digital Video/MP3 :

For Digital Video/MP3 , press the INT button is not available .

3). RDM(RANDOM) FUNCTION

During DISC playback, touch screen of “ ” section (press the **RDM** button on the remote control to play in random. Each play mode the order is different . (Depend on the disc used for VCD).

Touch it again to cancel this function .

Note : in random mode, the button is not available .

ON-SCREEN DISPLAY FUNCTION

During playback, touch the screen or press the **OSD** on the remote control, it will display the following as below :

Note: touch the screen or press the OSD on the remote control again to cancel the OSD information.

1. Digital Video , when it is on, it will display the information such as:



2. Example for VCD/SVCD, when it is on, it will display the information such as:



3. Example for Movie or PHOTO . When it is on, it will display the information such as:



DISC Search (GOTO)

FOR Digital Video :

Touch the screen as show or press the GOTO button on remote control;

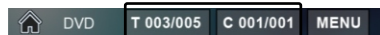

the screen will display the following message :

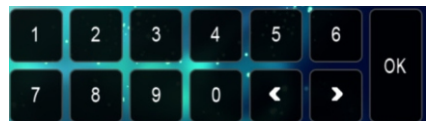

Touch the to select the your adjustment item, then select the item your favour by touching the numeric buttons , then touch the **OK** button to confirm .

Touch Screen Operation

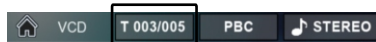

FOR VCD (With PBC OFF) :

Touch the screen as show or press the GOTO button on remote control;

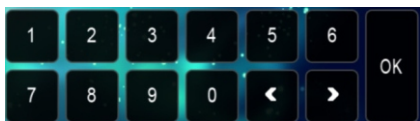

the screen will display the following message :



Touch the   to select the your adjustment item, then select the item your favour by touching the numeric buttons , then touch the **OK** button to confirm .

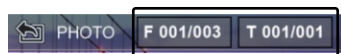

For Movie/Photo:

Touch the screen as show or press the GOTO button on remote control;

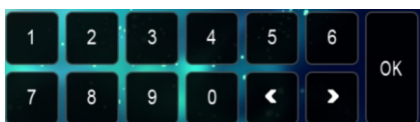

the screen will display the following message :



Touch the   to select the your adjustment item, then select the item your favour by touching the numeric buttons , then touch the **OK** button to confirm .

Touch Screen Operation

Digital Video Special Function

1. Multi-subtitle Language Function (for Digital Video Only)



During Digital Video playback. Touch the  icon on touch screen (or press the **SUBT** on the remote) .

Each time the button is pressed or touch, number of the subtitle language changes in sequential order.

Notes:

- The language number is different according to the disc.
- Some discs only contain one subtitle language.
- When no different subtitle language are recorded, " **INVALID KEY** " will be displayed at screen left top corner.

2. Multi-Audio Language Function



For Digital Video:

During Digital Video playback , touch the  icon on touch screen (or press the **LANG**

on the remote .) Each time the button is pressed or touch , number of the audio soundtrack language changes on sequential order.

Notes:

- The language number is different according to the disc.
- Some disc only contain one language soundtrack
- When no different language soundtrack are recorded " **INVALID KEY** " will be display at screen left top corner.

For VCD/CD:

during playback, touch the **AUDIO** section of the touch screen or Press **AUDIO** on the remote . It is possible to switch the sound between monaural and stereo sound.

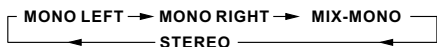

3. Multi-Angle Function (for Digital Video Only)

During Digital Video playback, touch the  icon on the touch screen . Each time the button is pressed , the number of the angel changes in sequential order .

Notes:

- The angle number is different according to the disc.
- The function only work for disc having scenes recorded at different angles.
- When no different angle are recorded, " **INVALID KEY** " will be displayed at screen left top corner.

4. Title Menu Function

For Digital Video:

If the Digital Video has multiple titles recorded on the disc. It can select preferred title from the title menu to start playback.

- During Digital Video playback, press **TITLE** button on the remote . The title menu is display.
- Select preferred title by the cursor button and confirmed by press the **ENTER** button .

For VCD:

Press **TITLE/PBC** button on the remote control while the disc is playing, you can switch between "PBC ON" and "PBC off" mode.

Touch Screen Operation

5. A-B Repeat (for Digital Video and VCD)

Press the **A-B** button if you want to repeat a specific segment on a disc that you define:

1. Press the **A-B** button at a point (A) where you want it to be the start point of the repeat segment. Press the **A-B** button again at a point (B) where you want it to be the terminal point of the repeat segment. Then it will play the segment repeatedly.
2. To cancel the A-B repeat mode and resume normal playback, press the **A-B** button for the third time.

Note:

During DVD playback, points A and B can be selected from different chapters.

6. Program Playback (for Digital Video and VCD)

It allows you to enter the order in which you want some chapters/tracks in DVD/VCD to play.

- 1 During playback, press the PROG button to enter a program interface as follows:

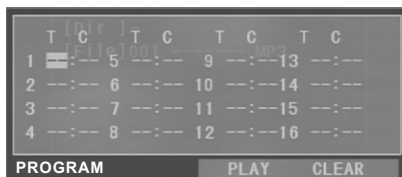

Program interface for DVD

- 2 Use the direction buttons to move cursor onto the desired place for inputting the sequence number.

- 3 Use the number button to input desired sequence number of title/ chapter/track with desired sequence.

- 4 After input your favour, press >|| on remote or use the direction buttons to select play and then press OK on remote to play the programmed titles/ chapters/tracks in programmed order.

* Tap the display or press stop button to exit the PROG .

* During VCD playback, if it is in PBC ON mode, at the same time of entering the state of program playback, it turns off PBC mode.

7. Display still frame step by step (for Digital Video and VCD)

If the unit is currently playing video, press the STEP button consecutively to display still frame step by step.

Press the PLAY button to resume normal playback.

8. Playback with Slow Speed

During video playback , press the LOC/SLOW button to execute the Slow Forward function.

Press the PLAY button to resume normal playback.

Touch Screen Operation

BT Operation

1. Pairing and Connecting

Prior to using the BT device named Boss Audio BV8974B as a hands-free system for a BT-enabled mobile phone for the first time, you must pair and connect them as follows:

- * Prior to pairing and connecting, when displaying No Video interface of radio, CD, AUX IN or BT music, the logo BT flashes in the touch screen.
- * During operation of the device named Boss Audio BV8974B as a hands-free system for a BT-enabled mobile phone, place the BT-enabled mobile phone no more than 3 meters from the head unit;

Switch on the BT mode of your mobile phone; then select the item to find a BT device and enter it; When it finds the BT device of the car A/V system, the name Boss Audio BV8974B will be displayed, select it and enter it; then it will show an interface that asks you to input a password, input 0000 and enter it; then it will pair and connect with the BT device Boss Audio BV8974B of the car A/V system, Confirm it, then the frame of the BT logo will light all the time.

- * When finishing pairing and connecting, the audio of the mobile phone transfers to the car audio system whenever a call is made or received or the mobile phone plays music.

2. BT PHONE



In power off mode, a incoming call or call out to wake up this unit and turn to BT hands-free mode, when the phone call ended the unit back to power off mode.

1) Make a call

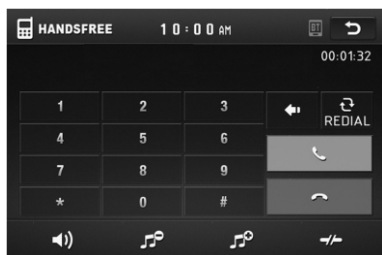
- (1) Dial with mobile phone directly;
 - (2) Dial with the controls on BT PHONE interface or on remote control or on control panel;
- a. Touch the HANDSFREE icon in home menu or touch the  icon during playing to turn to BT PHONE interface as follows:



 : Same as MUTE button.

 &  : Same as VOL+ and VOL- or VOL knob.

 : Tap to do disconnection.

Touch Screen Operation

b. Use the number icons or buttons to input your desired phone number;





* When inputting a wrong digit, use  icon or < button to delete it.

c. After finishing inputting, touch  icon or press  button on control panel to dial out.

2) Redial last dialed phone number

Touch  icon or long press redial button on remote control to dial out the last dialed phone number.



3) Answer a call

During an incoming call, the incoming telephone number displays in the the BT PHONE interface. If you want to receive it, touch  icon or press  button on remote control; if you want to reject it, touch  icon or press  button on remote control.



4) Ending a call

When ending a call, touch  icon or use  button.

5) Switch the audio between the unit and your device

During phone talking using the BT hands-free system of the car A/V system, touch  icon or press  button on remote control to switch the audio between the unit and your device.

6) Adjusting the volume during a call

During phone talking, use  and  icon or VOL knob or VOL+ and VOL- buttons to adjust volume level; use  icon or MUTE button to mute sound.

* * / # icons and buttons







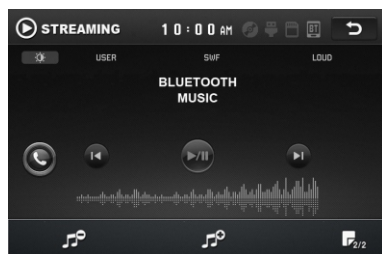
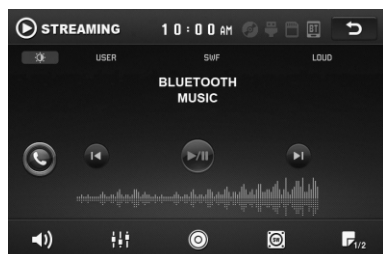



they perform as * / # buttons on mobile phone.

3. BT MUSIC

1) Touch STREAMING in home menu or pressing SOURCE button can pop up BT MUSIC interface as follows:







Touch Screen Operation

-  Mute function
-  To select the Equalizer mode
-  To decrease the volume level
-  To increase the volume level
-  Loudness Function
-  Subwoofer Function
-  Play/Pause the playing
-  To skip the next track
-  To skip the previous track
-  Tap to turn to BT PHONE mode.(after pairing and connecting a mobile phone with BT function).

In BT music mode, tap  icon to adjust the brightness for the display .

- 2) When using your mobile phone with the BT function to play audio/video, if it is paired and connected to the unit, the audio of the mobile phone will change into the car A/V system.

The Boss Audio supports A2DP, which enables the user to stream audio from their device.

- 3) The BT device of the car A/V system supports AVRCP, so these icons on the BT Music interface except BT Music and their corresponding buttons on control panel or on remote control are available for audio/video playback of your mobile phone during playback. But no fast forward/backward functions for  /  icon and  /  buttons, and the function of resume playback after pausing or stopping is available only for some mobile phone.

Touch Screen Operation

AUX Operation

On the front panel of this unit, there is an AUX IN jack, follow the diagram below to connect analogue replay devices(only for the Audio connect, if you want to connect the Video, please plug the <Video input > on the back of the unit .). Use this jack to replay sound of other replay equipment such as Digital Video players, computers, etc. Via the loudspeakers.

1). Please connect the external device with stereo jack (3.5mm)plug the Aux in socket .

AUX IN JACK FRONT PANEL

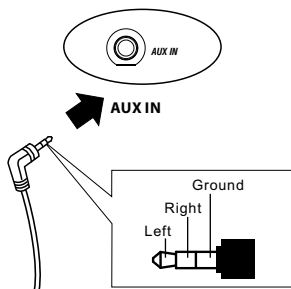

2). In radio mode, touch the screen of “▶” ICON to enter the main menu, touch the “AUX ” ICON to enter the AUX IN mode.

In AUX mode, tap  to adjust the brightness for the display .

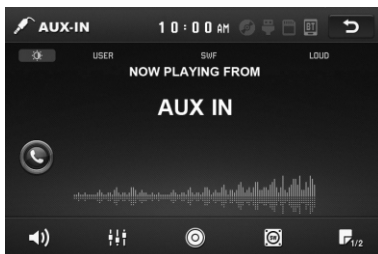



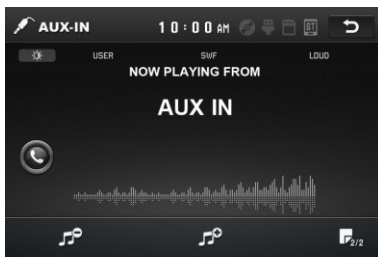



AUX INTERFACE 1



AUX INTERFACE 2

3). You now hear the sound from the external device played back through the loudspeakers .

The function of the icons as follow:

-  Tap to mute the sound.
-  Tap to select EQ as the same on the remote control.
-  Loudness Function
-  Subwoofer Function
-  Tap to adjust audio volume.
-  Tap to turn to BT PHONE mode. (after pairing and connecting a mobile phone with bluetooth function).

Touch Screen Operation

AV Operation

Please plug the <Video input > on the back of the unit .

Touch the AV IN icon to enter the AV IN mode.

In AV mode, tap  icon to adjust the brightness for the display .

As the interface show, here is only the audio output, now tap the  icon, the picture of the auxiliary input video show on the display and tap the display again to turn to audio mode.

Now you can watch the video from your External video equipment such as Digital Video players, computers, etc.

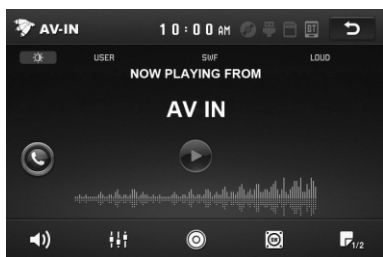

AV INTERFACE 1

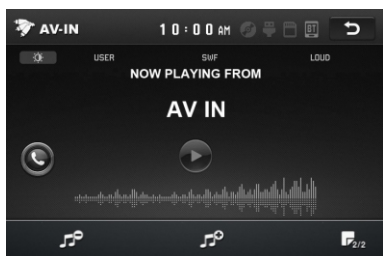

AV INTERFACE 2

The function of the icons as follow:



Tap to mute the sound.



Tap to select EQ as the same on the remote control.



Loudness Function



Subwoofer Function



Tap to adjust audio volume.



Tap to turn to BT PHONE mode. (after pairing and connecting a mobile phone with BT function).

Note: To ensure safety while driving and to comply with laws, drivers should not watch video or operate the video device while driving.

Touch Screen Operation

USB OPERATION

Following the diagram below, connect your USB device to the front panel USB port . If it is properly connected, the device will be mounted and start playing automatically.

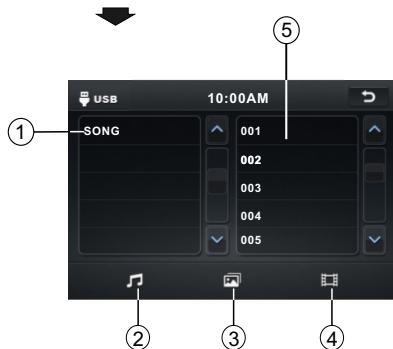
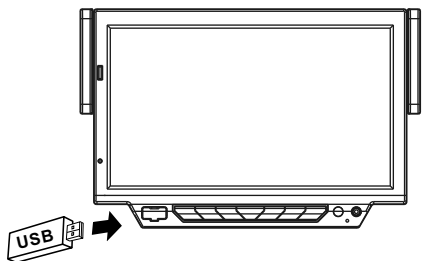

- 1 Current type (highlighted bar) .
- 2 Audio play mode select.
- 3 Picture play mode select.
- 4 Movie play mode select,
- 5 Current play track .

Card OPERATION

The unit can support playback MP3/WMA/ JPEG/MP4 format which are stored on SD memory cards .

Please read the following instructions before you start using a memory card . Inserting the card as follow:

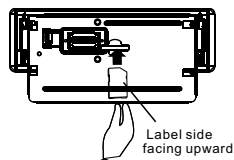

Insert a card, push in till heard a "CLICK", then attach the control panel again to play.

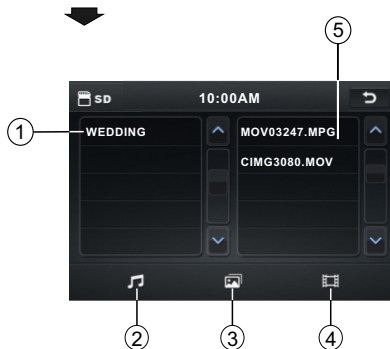
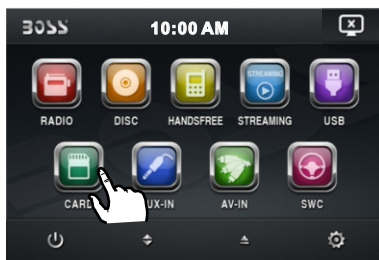



- 1 Current type (highlighted bar) .
- 2 Audio play mode select.
- 3 Picture play mode select.
- 4 Movie play mode select,
- 5 Current play track .

Touch Screen Operation

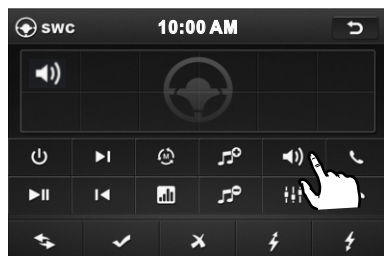

STEERING WHEEL CONTROL

Touch the SWC icon as follow to turn to steering wheel control .



During setting, touch the  icon to turn to home menu.

Before operation, press the  icon to cancel the original input that to set your favour.

There are 2 KEY for total 12 buttons to save, first, tap Assign to open function save, then select button 1 in KEY 1 on steering wheel and tap the  icon, the icon show in button 1 position then touch Confirm, final exit the SWC mode, the  function will save in button 1 of KEY 1.

The function of the icons as follow:



Touch to begin function save.



After selection touch to confirm operation.



Touch this icon to cancel the input and resume load.



When electric resistance is too low, touch this icon to increase.



When electric resistance is too high, touch this icon to reduce.

Parental Control

* Parental Control

- Q: After inserting a Digital Video disc into the disc slot, if a dialogue box pops up and asks you to input a password, what should you do ?
- A: The playing disc is locked by a rating level of parental control. If the current rating level of parental control of the Digital Video player is lower than the one of current disc, you must input the correct password of parental control to unlock the parental control and enter a rating level equal to or higher than one of the current disc in order to play the disc.
- * For factory preset password of parental control of Digital Video player, please see the part of Media Setup Menu.

Appendix: Parental Control

Parental Control function of a Digital Video player can control playback of movie ratings on a disc. You can set the Digital Video player to be a certain rating level of parental control using the Media Setup Menu. If the rating level of parental control of a disc is higher than the one of the Digital Video player, the Digital Video player cannot play the disc.

The Digital Video movie can be designed so that the Digital Video player can play different versions of content of a particular movie according to the different rating levels of parental control. Depending on the Digital Video features, the scenes that are not suitable for children will be cleared or replaced by suitable scenes automatically.

The rating levels of Parental Control are as follows:

- | | |
|---|----------|
| | Unlock |
| 1 | Kid Safe |
| 2 | G |
| 3 | PG |
| 4 | PG 13 |
| 5 | PGR |
| 6 | R |
| 7 | NC 17 |
| 8 | Adult |

Region Code

* Region Code

If you insert a disc into the disc slot and REGION ERROR is displayed, the car multi-media system can not play the disc. The reason is that the region codes of the car multi-media system and the used disc do not match each other.

Appendix: Region code of Digital Video

Motion Picture Association of America (MPAA) divided the world into 6 regions, and gave every region a region code for locking and unlocking Digital Video playback.

Basically, a coded Digital Video player can play only the discs if its region code is the same as the code of the Digital Video player. Otherwise, it cannot play the disc.

Please note that only the Digital Video discs and Digital Video players produced by the 8 biggest film-making companies of America impose this restriction. The Digital Video discs and Digital Video players not produced by the 8 biggest film-making companies of America are not restricted by the rule of region code. Generally, they are called Free Region Code or Full Region Code.

The problems caused by area code inconsistency has motivated the production of unlocked version Digital Video players and recodable Digital Video players .

Region codes and the countries or areas represented by region codes are as follows:

Region 1: America, Canada, East-Pacific Inlands;

Region 2: Japan, West Europe, North Europe, Egypt, South Africa, Middle East;

Region 3: South-east Asian countries include Taiwan, Hong Kong, South Korea, Thailand, indonesia, etc.;

Region 4: Australia, New Zealand, Central South America, South Pacific Inlands;

Region 5: Russia, Mongolia, Indian Peninsula, Middle Asia, East Europe, North Korea, North Africa, North-west Asia etc.;

Region 6: China mainland.

The 8 biggest film-making companies of America are as follows:

1. WarnerBros;
2. Columbia;
3. 20thCenturyFOX;
4. Paramount;
5. Universal;
6. UA(UnitedArtist);
7. MGM(MetroDogwynMayer);
8. WaltDisney

Troubleshooting

Before going through the check list, check wiring connection. If any of the problems persist after check list has been made, consult your nearest service dealer.

SYMPTOM	CAUSE	SOLUTION
No power	The car ignition switch is not on	If the power supply is properly connected to the car accessory terminal, switch the ignition key to "ACC"
	The fuse is blown	Replace the fuse
Disc can not be loaded or ejected	Presence of disc inside the player.	Remove the disc in the player, then put a new one
	Inserting the disc in reverse direction	Insert the compact disc with the label facing upward
	The disc is extremely dirty or defective	Clean the disc or try to play a new one
	Temperature inside the car is too high	Cool off or until the ambient temperature return to normal
Video/image appears black-white	The color system is set incorrectly	Please switch to correct color system from menu
No video/image appears	The unit is not connected to the parking brake detection switch	Make proper connection according to "wire connection"
	The parking brake is not engaged	For safety reasons no video/ images are displayed while the vehicle is moving. Engaging the parking brake will cause images to be displayed.
No color in picture	The disc format is not according to the TV-set used (PAL/NTSC)	Please choose a proper color system.
JPEG disc can not be played back	No JPEG files are recorded on the disc.	Change the disc
	JPEG files are not recorded in a compliant format	Change the disc Record JPEG files using a compliant application
Unit has become unresponsive	Unit has frozen up	Press the RESET button. Front panel is not properly fixed into its place
The radio does not work	The antenna cable is not connected	Insert the antenna cable firmly
	The signals are too weak	Select a station manually