

STEELMAN®

LITHIUM-ION BATTERY JUMP STARTER WITH SPOTLIGHT AND AREA LIGHT OPERATOR'S MANUAL

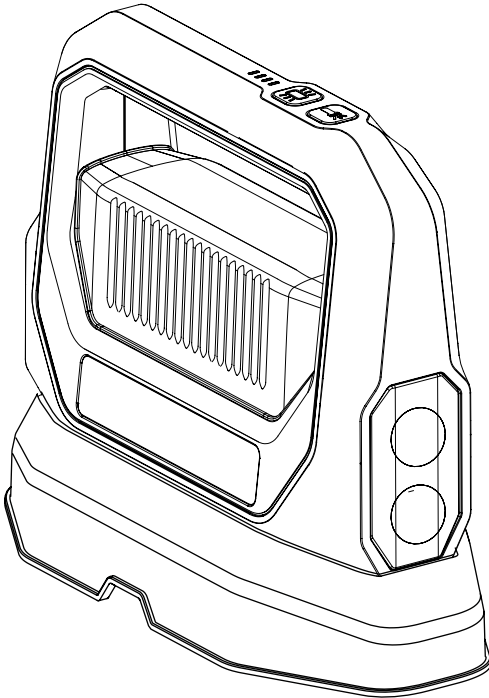

⚠ CAUTION: To reduce the risk of injury, user must read and understand this operator's manual. Save these instructions for future reference.

TABLE OF CONTENTS

SAFETY AND WARNINGS	2-4
PRODUCT FEATURES	4-5
OPERATION	6-9
WARRANTY	9
NOTES	10-11

SAFETY AND WARNINGS

GENERAL SAFETY WARNINGS

READ AND UNDERSTAND ALL SAFETY INFORMATION BEFORE USING THIS PRODUCT. Failure to follow these safety instructions may result in **ELECTRICAL SHOCK, EXPLOSION, FIRE**, which may result in **SERIOUS INJURY, DEATH, OR PROPERTY DAMAGE**.

ELECTRICAL SHOCK

Product is an electrical device that can shock and cause serious injury. Do not cut power cords. Do not submerge in water or get wet.

EXPLOSION

Unmonitored, incompatible or damaged batteries can explode. Do not leave product unattended while is in use. Do not attempt to jump start a damaged or frozen battery. Use product only with batteries of recommended voltage. Operate product in a well ventilated area.

FIRE

Product is an electrical device that emits heat and is capable of causing burns. Do not cover product. Do not smoke or use any source of electrical spark of fire when operating product. Keep product away from combustible materials.

EYE INJURY

Wear eye protection when operating product. Batteries can explode and cause eyes and skin irritation. In the case of contamination of eyes or skin, flush affected area with clean running water and contact a physician immediately.

EXPLOSIVE GASES

Working in the vicinity of a lead-acid battery is dangerous. Batteries generate explosive gases during normal battery operation. To reduce risk of battery explosion, follow all safety information instructions and those published by the battery manufacturer and manufacturer of any equipment intended to be used in the vicinity of battery. Review cautionary markings on these products and on engine.

IMPORTANT SAFETY WARNINGS

Personal Precaution. Only use product as intended. Someone should be within range of your voice or close enough to come to your aid in case of emergency. Have a supply of clean water and soap nearby in the case of battery acid contamination. Wear complete eye protection and protective clothing while working near a battery. Always wash hands after handling batteries and related materials. Do not handle or wear any metal objects when working with batteries including; tools, watches or jewelry. If metal is dropped onto battery, it may spark or create a short circuit resulting in electrical shock, fire, explosion which may result in injury, death or property damage.

CHOKING HAZARD

Accessories may present a choking hazard to children. Do not leave children unattended with product or any accessory. The product is not a toy.

HANDLING

Handle product with care. The product can become damaged if impacted. Do not use a damaged product, including, but not limited to, cracks to the casing or damaged cables. Do not use product with a damaged power cord. Humidity and liquids may damage product. Do not handle product or any electrical components near any liquid. Store and operate product in dry locations. Do not operate product if it becomes wet. If product is already operating and becomes wet, disconnect it from the battery and discontinue use immediately. Do not disconnect the product by pulling on the cables.

MODIFICATIONS

Do not attempt to alter, modify or repair any part of product. Disassembling product may cause injury, death or damage to property. If product becomes damaged, malfunctions or comes in contact with any liquid, discontinue use. Any modifications to the product will void your warranty.

ACCESSORIES

This product is only approved for use with included accessories. JS Products is not responsible for user safety or damage when using accessories not approved in writing by JS Products.

LOCATION

Prevent battery acid from coming in contact with the product. Do not operate the product in a closed-in area or an area with restricted ventilation. Do not set a battery on top of product. Position cable leads to avoid accidental damage by moving vehicle parts (including hoods and doors), moving engine parts (including fan blades, belts, and pulleys), or what could become a hazard that may cause injury or death.

OPERATION TEMPERATURE

This product is designed to work in the ambient temperatures between -22°F to 140°F (-30°C to 60°C). Do not operate outside of temperature ranges. Do not jump start a frozen battery. Discontinue use of product immediately if the battery becomes excessively warm.

STORAGE

Do not use or store your product in areas with high concentrations of dust or airborne materials. Store your product on flat and secured surfaces so it's not prone to falling. Store your product in a dry location. The storage temperature is -4°F to 77°F (-20°C to 25°C, average temperature). Never exceed 176°F (80°C) under any condition.

COMPATIBILITY

The product is only compatible with 12-volt lead-acid batteries only. Do not attempt to use product with any other type of battery. Jump starting other battery chemistries may result in injury, death or property damage. Contact the battery manufacturer prior to attempting to jump start the battery. Do not jump start a battery if you are unsure of the battery's specific chemistry or voltage.

BATTERY PACK

The built-in lithium-ion battery in the product must be recycled or disposed of separately from household waste. Don't attempt to replace the battery yourself and do not handle a damaged or leaking lithium-ion battery. Never dispose of battery in household trash. Disposal of batteries in household trash is unlawful under state and federal environmental laws and regulations. Always take used batteries to your local battery recycling center. If the battery is excessively hot, emitting odor, deformed, cut, or is experiencing or demonstrating an abnormal occurrence, stop using the product immediately.

BATTERY CHARGING

Charge the product with the included USB charging cable, ≥ 10 W 12V to 5V Car Charger Plug, or the Wall Adapter. A third-party USB cable, ≥ 10 W Car Charger Plug or Wall Adapter may be compatible but not recommended. Be cautious of using low quality power adapters, as they may present a serious electrical risk that can result in injury to person, device and property.

Using damaged cables or chargers, or charging when moisture is present, can result in electric shock. Using generic or third party power adaptor may shorten the life of your product and cause the product to malfunction. JS Products is not responsible for the user's safety when using accessories that are not approved in writing by JS Products.

To ensure maximum battery life, avoid charging your product for more than a week at a time, as overcharging may shorten battery life. Over time, an unused product will discharge and must be recharged before use. Disconnect the product from power sources when not in use. Use the product only for their intended purposes.

MEDICAL DEVICES

Product may emit electromagnetic fields. Product contains magnetic components which may interfere with pacemakers, defibrillators, or other medical devices. These electromagnetic fields may interfere with pacemakers or other medical devices. Consult with your physician prior to use if you have any medical device including pacemakers. If you suspect the product is interfering with a medical device, stop using the product immediately and consult your physician.

MEDICAL CONDITIONS

If you have any medical conditions that you believe could be affected by product, including but not limited to; seizures, blackouts, eyestrain or headaches, consult your physician prior to use of product.

CLEANING

Power off the product before attempting any maintenance or cleaning. Clean and dry product immediately if it comes in contact with liquid or any type of contaminant. Use a soft, lint-free (microfiber) cloth. Avoid getting moisture in the housing openings or metal contacts.

EXPLOSIVE ATMOSPHERES

Obey all signs and instructions. Do not operate product in any area with a potentially explosive atmosphere, including fueling areas or areas which contain chemicals or particles such as grain, dust or metal powders.

HIGH-CONSEQUENCE ACTIVITIES

This product is not intended for use where the failure of the product could lead to injury, death or severe environmental damage.

PRODUCT FEATURES

PRODUCT FEATURES	
#	DESCRIPTION
1	Main Switch
2	Switch for SOS Mode
3	Switch for Mandatory Jump Start
4	USB Ports
5	Jump Start Status Indicator
6	Battery Status Indicator

PRODUCT FEATURES	
#	DESCRIPTION
7	Switch for LED Area Light
8	Switch for LED Spotlight
9	Area Light
10	Spotlight
11	Booster Cables and Clamps
12	USB Charging Cable

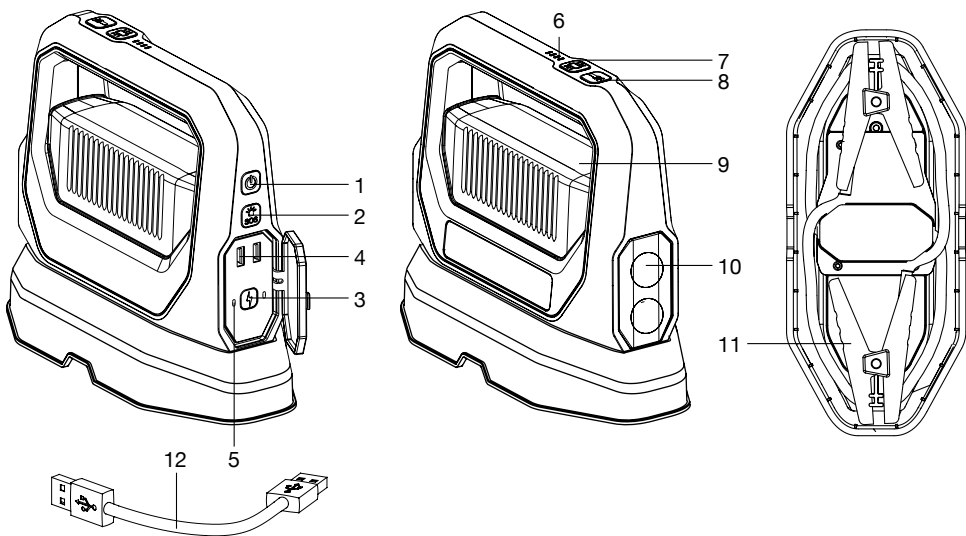

BATTERY STATUS INDICATOR

LED INDICATOR	POSSIBLE CAUSE	SOLUTION
Red-Red-Blue-Blue	Low temperature alarm	Wait 5-15 minutes until the unit is warm
Red-Red-Red-Blue	High temperature alarm	Wait until the unit is cooled
Red-Red-Red-Red (Alarm buzzer will sound)	Incorrect connection sequence	DO NOT USE: Follow the proper connection steps
Off-Off-Off-Off (Alarm buzzer will sound)	Reversed clamps connection	Correct the clamp polarity
Off-Blue-Blue-Blue (Flashlight LED)	Ready to jump-start the vehicle	
Off-Blue-Blue-Blue	Charging in progress	
Red-Off-Off-Off (Flashing LED)	Low battery level	Recharge the unit

OPERATION

GETTING STARTED

This product comes partially charged, and needs to be fully charged prior to use. Carefully read and understand the vehicle owner's manual on specific precautions and recommended methods for jump-starting the vehicle. Make sure to determine the voltage and chemistry of the battery by referring to your battery owner's manual prior to using this product. This product is for jump-starting 12-volt lead-acid batteries only.

CONNECTING THE BATTERY

Before connecting to the battery, verify that you have a 12-volt lead-acid battery. Make sure all of the vehicle's power loads (headlights, radio, air conditioning, etc.) are turned off before attempting to jump start the vehicle.

USING JUMP START

Always wear safety goggles and protective gear while jump starting a battery.

1. Turn on the main switch, check power indicator, if the indicator showing less than 75% capacity, recharge unit before use (FIG 1).
2. Red clamp connects to the positive terminal (+) of the battery, black clamp connects to the metal part of the vehicle (ground) or the negative terminal (-) of the battery. Jump Start Status LED will illuminate Green first, wait for ~3 seconds for the system to be ready (FIG 2) then start the vehicle.

FIG. 1

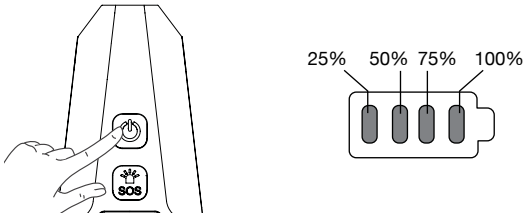
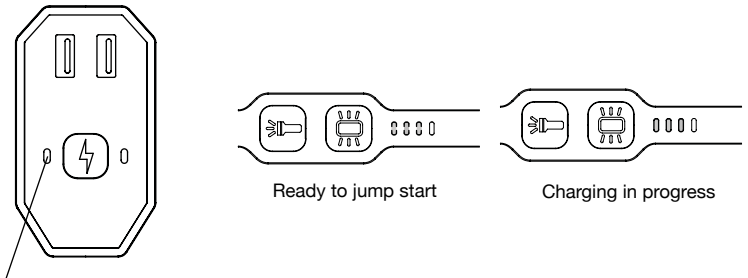

FIG. 2



The green LED will turn on, wait 3 seconds for system to be ready.

! IMPORTANT:

- a. Always turn on the main switch first before connecting the clamps to the positive and negative terminals of the battery.
- b. If clamps are connected to the positive and negative terminals first, then turn the main switch on, Jump Start Status Indicator LEDs will flash alternately (Green and Red LED). Reference FIG 3. Battery Status Indicator will illuminate in all RED, and the alarm buzzer will sound. Remove clamps turn off unit. Restart with correct sequence.
- c. If the battery clamps are reversed, the Jump Start Status Indicator will be OFF, reference FIG 4, and the alarm buzzer will sound. Remove and reverse clamps, restart.

FIG. 3

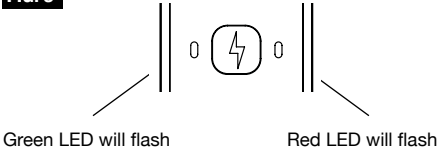
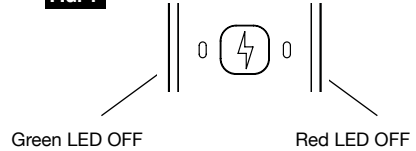

FIG. 4



3. Turn off the Main Switch once the vehicle is running.
4. Remove the clamps, by removing the negative terminal clamp first.

! IMPORTANT: The device will be doing a 50-second countdown when jump-starting the vehicle, if it doesn't start the vehicle after 50 seconds, remove the negative terminal (-) clamp that is connected to the metal part of the vehicle (ground) or the negative terminal (-) of the battery, then reconnect and try again.

MANDATORY START FUNCTION

This unit features a Mandatory Start button. You can use this feature when the car battery voltage is less than 2V or completely drained. Press the Mandatory Start button for 3 seconds (wait for 3 beeps) to engage the function.

! IMPORTANT: ALL automatic protection systems will be override when using this feature. It is imperative to ensure the clamp connection is correct and secure before use. The Mandatory Start feature can damage your vehicle and or the Jumpstart if not connected correctly.

1. Turn on the main switch, check power indicator, if the indicator showing less than 75% capacity, recharge unit before use.
2. Red clamp connects to the positive terminal (+) of the battery, black clamp connects to the metal part of the vehicle (ground) or the negative terminal (-) of the battery. Jump Start Status Indicator LED will illuminate first, wait for ~3 seconds for system to be ready for service.
3. Press and hold the Mandatory button for ~3 seconds, Jump Start Status Indicator LED will flash then illuminate.

! IMPORTANT: The device will be doing a 30-second countdown when jump-starting the vehicle with Mandatory Start feature, if it doesn't start the vehicle after 30 seconds, depress and hold  for ~3 seconds to re-engage the Mandatory Start feature.

⚠ IMPORTANT: ALL automatic protection systems will be override when using this feature. It is imperative to ensure the clamp connection is correct and secure before use. The Mandatory Start feature can damage your vehicle and or the Jumpstart if not connected correctly.

4. Wait ~3 seconds, then start the vehicle.
5. Turn off the Main Switch once the vehicle is running.
6. Remove the clamps, by removing the negative terminal clamp first.

LED LIGHTS - USING LED SPOTLIGHT

1. Turn on the main switch.
2. Depress and release the spotlight button will cycle through the different modes (High-Low-Off).

LED LIGHTS - USING LED AREA LIGHT

1. Turn on the main switch.
2. Depress and release the spotlight button will cycle through the different modes (High-Low-Off).

LED LIGHTS - USING SOS MODES

1. Turn on the main switch.
2. Depress and release the SOS button will cycle through the different SOS modes (SOS with Spot Light, SOS with Area Light, SOS with RED Area Light, Off).

USB PORTS - OUTPUT

To recharge the portable electronic devices, turn the Main Switch on, pull open the rubber cover, then plug in the USB cable. The USB is V3.0 with quick-charge function. Removing the USB cable and replace the rubber cover after use.

NOTE: Turn off the Main Switch after use to save battery energy. The unit will automatically enter Sleep Mode after 2 minutes with no devices connected, or detecting any activities.

USB PORTS - RECHARGING

Turn the Main Switch off, then insert USB plug into a suitable USB power source (5V/2A), and insert the other end into one of the USB ports under the rubber cover.

⚠ IMPORTANT: Improper handling of the rechargeable battery may result in damage to the unit. Avoid deep discharge of the built-in rechargeable battery. The built-in rechargeable battery must be recharged after every use and at least once a month even when the charge level indicator displays three bars. Depress and release Main Switch to check battery status. **DO NOT** operate any auxiliary functions during recharging. Jump-start, USB port **CANNOT** be used simultaneously.

TECHNICAL DATA

Model: 61057

Battery Capacity: 12000mAh (12V/4AH)

Internal Battery Type: Lithium-ion Battery

Charger Input: USB 5V/2A

USB Output: 5V 3A Max.

Cranking Current: 500Amp

Peak Current: 2000Amp

Charging Time: 7-8 Hours (Full Charge)

Operating Temperature: -22°F ~ 140°F (-30°C ~ 60°C)

Product Dimensions: 8.94 x 3.15 x 6.8in. (227x80x175mm)

Area Light Max Output: 500lm

Spotlight Max Output: 500lm

NOTE: Specifications subject to change without notice. Do not dispose of this product in the usual household garbage at the end of its life cycle; hand it over at a collection point for the recycling of electrical and electronic appliances. The symbols on the product, the instructions for use or the packing will inform about the methods for disposal. Keep this instruction manual for future reference.

WARRANTY



1 YEAR | LIMITED WARRANTY

This STEELMAN® product is backed by a 1 Year Limited Warranty. This warranty covers manufacturer defects and workmanship. The warranty excludes misuse or abuse and normal wear and tear. Exclusion is not allowed in some states and may not apply. This warranty gives you specific legal rights, and you may have other rights, which vary from state to state.

For questions / comments, technical assistance or repair parts, Please call toll free at: 1-855-706-1550 (M-F 6am - 4:30pm PST)

Before sending a unit back for repair, an RMA (return materials authorization) number must be obtained and written on the outer shipping box. Please submit a ticket online at <http://www.steelmantools.com/contacts> to receive an RMA number. We will determine if the unit needs to come in for repairs or replacement. Warranty claims that cannot be processed through the point of purchase and any other product related questions should be addressed directly to JS Products.

NOTES



STEELMAN®

11.12.2021

JS PRODUCTS • 6445 MONTESSOURI STREET • LAS VEGAS, NV 89113
CUSTOMER SERVICE: 1-855-706-1550 • WWW.STEELMANTOOLS.COM