

**ASSEMBLY  
INSTRUCTIONS**

Item : Nylah Oval Coffee Table

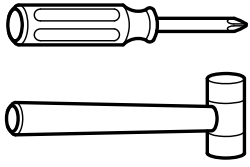

Not Provided

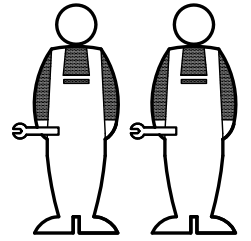
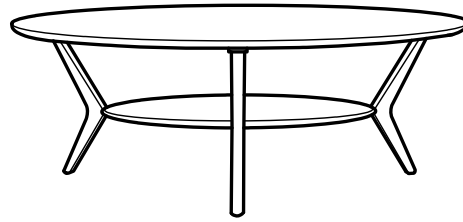





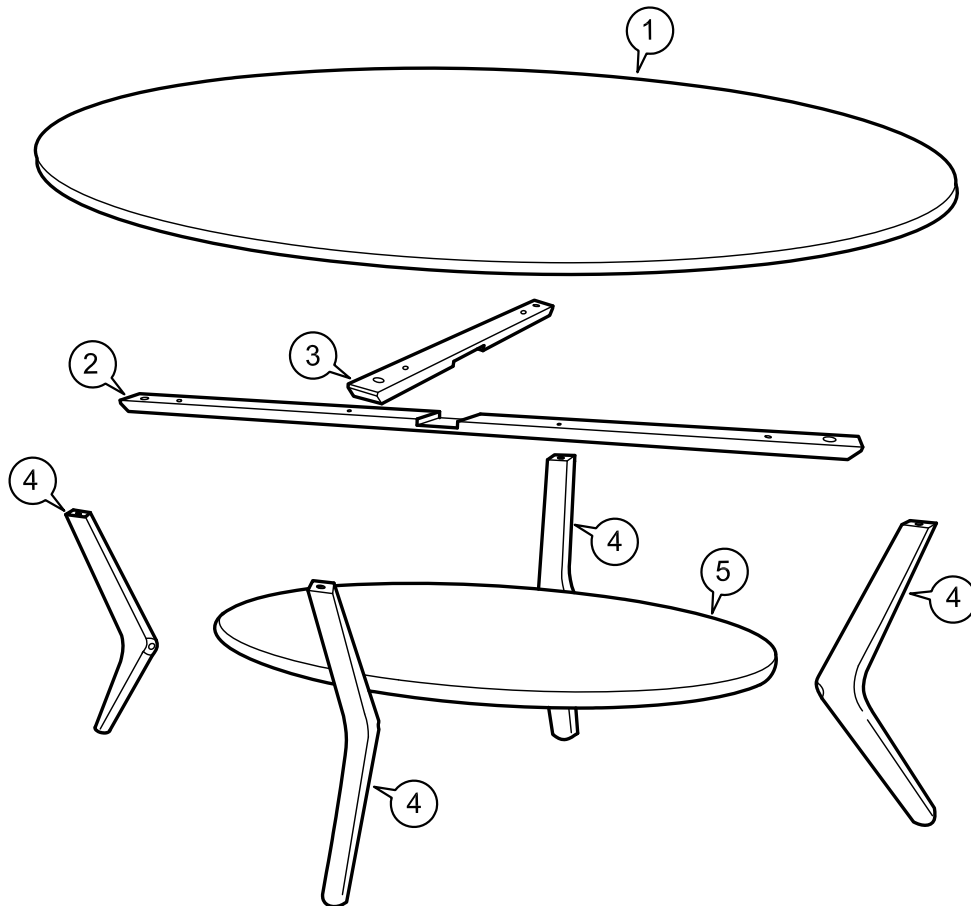

2 Persons

DO NOT fully tighten any of the bolts until the product is completely assembled, then put on a flat surface to make sure the product is level and then fully tighten all the bolts.

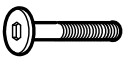
**Part List**

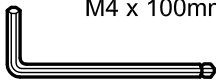

**HARDWARE LIST :**

<p>A M6 x 30mm = 8</p> 	<p>C 1/4" = 4</p> 	<p>E M8 = 4</p> 	<p>G M4 x 100mm = 1</p> 
<p>B JCCA M6 x 60mm = 4</p> 	<p>D M6 x 13mm = 8</p> 	<p>F M4 x 28mm = 2</p> 	<p>H = 4</p> 

1

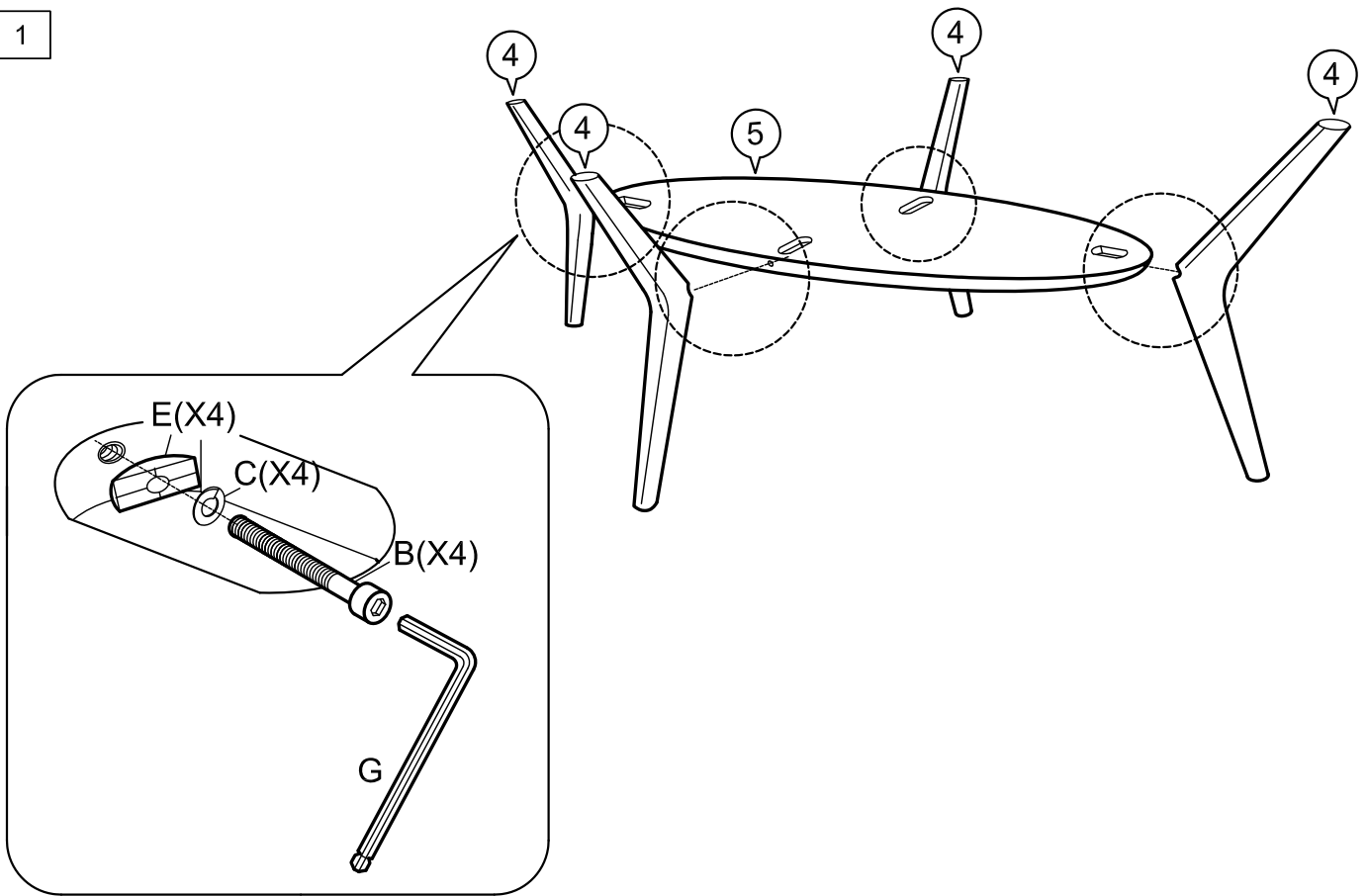

2

