



NILES®

Niles Audio Corporation

www.nilesaudio.com

12331 S.W. 130 Street
Miami, Florida 33186
Tel: (305) 238-4373
Fax: (305) 238-0185

©2003 Niles Audio Corporation. All rights reserved. Niles, the Niles logo, and Blending Technology and Architecture are registered trademarks of Niles Audio Corporation. Decora is a registered trademark of Leviton Manufacturing. All other trademarks are the property of their respective owners. Some of Niles products (or components thereof) are manufactured under one or more U.S. Patents, foreign equivalents and/or pending patents (see product for details). Because we constantly strive to improve our products, Niles reserves the right to change product specifications, descriptions, and prices without notice. The technical and other specifications of information contained herein is not intended to set forth all technical and other specifications of Niles products. Additional information can be obtained at www.nilesaudio.com or by calling Niles at 1-800-289-4434. Printed in China 7/03 DS00310BCN

INSTALLATION & OPERATION GUIDE

VCS 100



VCS 100R

High-Power Stereo Volume Controls



NILES®

BLENDING HIGH FIDELITY AND ARCHITECTURE®

VCS 100

VCS 100R

TABLE OF CONTENTS

Introduction	1
Features and Benefits	1
Installation Considerations	3
Installation	6
Operation	8
Specifications	9
Contents	9



INTRODUCTION

The VCS 100 is a wall mount, stereo speaker volume control. It connects between the speaker-level output of an amplifier, speaker selector, or distribution hub and a pair of speakers.

A perfect application for the VCS 100 is adjusting the volume of remotely located speakers. The VCS 100 adjusts the volume of speakers connected to it by attenuating the amplifier signal. To assure minimal dissipation of internal power with virtually no power wasted as heat, Niles volume controls use autoformers instead of L-pads as the volume-controlling element.

The VCS 100 is an impedance-magnifying (IM) volume control. Unlike other brands, it has additional autoformer windings that magnify the impedance of connected speakers, while allowing all 12 steps to adjust the volume of the sound. Switches on the PC board select these windings.

With the volume control providing impedance protection for your amplifier, you can create systems with no additional impedance-matching devices between the volume control and the amplifier.

In a typical application of IM controls, a system has eight pairs of 8-ohm speakers throughout the house and in adjacent outdoor locations. Connect each pair of speakers to an IM volume control with its switch in the 8x position, eliminating the need for an external impedance-matching device to protect the amplifier. Even when playing all eight speaker pairs at once, the amplifier runs at normal operating temperatures.

FEATURES AND BENEFITS

The VCS 100 offers a number of improvements over other volume controls:

- Interchangeable Decora-style inserts for fast, easy color change. Inserts and knobs (sold separately) are available in a variety of colors.
- A universal impedance-magnifying design enables the VCS 100 to act as both a stereo and an impedance magnifying volume control. You can magnify the speakers' impedance by a factor of two, four, or eight.
- Unlike other impedance-matching volume-control products, Niles IM volume controls maintain a 12-position adjustment regardless of how much impedance magnification you use, with total attenuation >48dB.
- Pop-free switching between all steps.
- Redesigned autoformers provide superior sonic performance, exceeding the audio quality of non-impedance magnifying volume controls.
- Isolated left and right-channel grounds ensure safety with any amplifier.

- May be used with 4-, 6-, or 8-ohm speaker systems.
- Ideal for home and commercial sound installations.
- UL rated to comply with all local building codes.
- Available colors: almond, black, bone, brown, and white.
- Installation requires only a screwdriver and wire stripper.
- Mounting depth of only 2-9/16". Fits into standard 18-cubic-inch one-gang junction boxes.
- Power handling: 100W/channel RMS.
- Frequency response: 20Hz to 20kHz \pm 2dB.
- Ten years parts and labor warranty.

TECH TIP

Some speakers have selectable impedance. Before you proceed, please confirm that any selectable-impedance speakers in your system are properly set for the system you are installing.

INSTALLATION CONSIDERATIONS

Calculating the Impedance Magnification Setting

Use the following instructions and the accompanying charts to select the correct switch setting for the number and type of speakers in your system.

CAUTION! Every speaker pair in the system must be connected to an impedance-magnifying volume control and set to the same magnification.

1. Count the number of pairs of 4-ohm speakers and the number of pairs of 8-ohm speakers you are connecting. Count pairs of 6-ohm speakers as 4-ohm pairs.
2. Determine whether the amplifier should see a 4-ohm load or an 8-ohm load. This information is typically found in the owner's manual of the amplifier.
3. Read the correct switch position from the charts on page 7. See **Figure 4** if your amplifier can drive a 4-ohm load. See **Figure 5** if your amplifier must have an 8-ohm speaker load.
4. Set the switches on all of the controls to the same position (1x, 2x, 4x, or 8x). See **Figure 7**.

Limitations in Volume with High Magnification Settings

Using an 8x setting limits the power to each speaker pair to one-eighth of the amplifier's output.

In a typical application of IM volume controls, a system has eight pairs of 8-ohm speakers throughout the house and in adjacent outdoor locations. Each pair of speakers is connected to an IM volume control with its switches set for 8x.

With eight pairs of speakers, one-eighth of the amplifier's power is available to any pair. Therefore, an amplifier rated at 100W per channel RMS into 8 ohms will deliver up to 12.5W to each of the eight pairs – whether you play all eight pairs or just one pair. This translates into a drop in the maximum volume capability of about 9dB at the 8x setting.

USING SPEAKER SELECTORS WITH IM VOLUME CONTROLS

Although IM controls provide volume and on/off at the volume-control location, they do not give you central control of speakers playing throughout the house.

TOOLS REQUIRED

- 1/8" Standard Slotted Screwdriver
- 1/4" Standard Slotted Screwdriver
- Wire Stripper

Speaker-selection systems give you central control, but some speaker selectors have non-defeatable impedance-protection circuits. Combining IM controls with such a selector will reduce your maximum volume substantially. To solve this problem, specify a speaker selector with a defeatable protection circuit (Niles models HPS4, HPS6, SS-4, or SS-6). Keep the protection circuit off at all times.

JUNCTION BOXES

The mounting depth of the VCS 100 is 2-9/16". When installed, the unit extends 2-1/16" behind the sheetrock wall (assuming 1/2" sheetrock). For installation, use a standard 18-cubic-inch (or larger) junction box. Suitable junction boxes are available from your Niles dealer or local electrical-supply company.

TYPE OF SPEAKER WIRE

We recommend 16-gauge stranded copper speaker wire for most connections, and 14-gauge wire for runs longer than 80 feet. Don't use speaker wire larger than 14 gauge, because larger wire may not fit into the connectors. Never use solid-core, aluminum, or

12 AWG



14 AWG



TECH TIP

Wire size is expressed by its AWG (American Wire Gauge) number. The lower the AWG number, the larger the wire. Thus, 12 AWG wire is physically larger than 14 AWG.

Romex wire with an IM volume control. For speaker-wire runs within walls, most U.S. states and municipalities require a special type of speaker wire with a specific CL fire rating, such as CL-2 or CL-3. Consult your Niles dealer, building contractor, or local building-inspection department if you aren't sure what kind of wire is best for your application.

MOUNTING LOCATIONS

Some states or municipalities allow installation of devices such as Niles speaker volume controls in the same junction box as 110V devices, with a low-voltage partition between the devices. We do not recommend this, because speaker wires can act as an antenna for electrical noise. Locating speaker wires too close to a light switch or dimmer may cause the speakers to emit a popping or buzzing sound. If you must locate the volume control near electrical devices, install it in a separate metal junction box, ground the box to the electrical-system ground, and route the speaker wires several feet away from the electrical wiring.

Convenient mounting locations include:

- Near doorways.
- Near a desk.
- At your bedside.
- Close to a telephone.
- Near other wall-mounted controls.

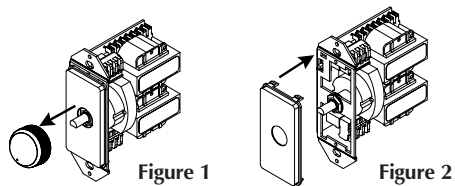

DECORA® FACEPLATES

The VCS 100 is designed to use standard and Decora-style faceplate mounting hardware. You can combine multiple Decora-style modules (if all are *low-voltage* controls) within one Decora faceplate (up to six-gang) with color-matched plate screws. Decora plates and screws are available from your Niles dealer.

CHANGING THE COLOR OF THE KNOB AND THE DECORA INSERT

The Decora-style insert and knob on the VCS 100 is removable, allowing fast and easy color changes as needed. Inserts and knobs are available in a variety of colors. To change the color of your unit:

1. Obtain the appropriate knob and Decora-style insert in the desired color from your Niles dealer.

2. Pull the knob off the shaft. See **Figure 1**.

3. Next, locate the two plastic mounting tabs at the top rear of the Decora-style insert. Using two fingers, simultaneously press both tabs down (towards the center of the insert) and forward (away from you) until the insert pops free from its mounting slots.

4. Locate the new Decora-style insert. Hold the volume control facing you. Insert the two bottom tabs into the bottom slots first, then the two tabs on the top (see **Figure 2**). Press carefully on the front of the insert to snap it into place.

5. Locate the new knob. Align its flat side to the flat side of the shaft, and push the knob onto the shaft. Holding the unit as shown in **Figure 1**, check the alignment of the knob by turning it through all positions.

PREPARING FOR INSTALLATION

Before you install the VCS 100 into an existing wall, consider the possibility of hidden obstructions inside the wall, such as wood and metal studs; electrical, telephone, or other wiring; plumbing; conduit; and old wall safes.

1. Install the junction box in the usual manner.
2. Run all necessary wiring to the volume control. Label the wires for future reference.

INSTALLATION

1. Locate the connector plugs (and remove them if they are plugged in). See **Figure 6**.

2. Strip 1/4" of insulation from the end of each wire. Tightly twist the end of each wire until no frayed ends remain.

3. Use a small flathead screwdriver or your thumbnail to raise the locking tabs, exposing the holes on the removable connector plug.

4. Insert each wire into the appropriate hole on the removable connector plug, and snap the locking tab down.

NOTE: *Maintain proper phasing. Connect the positive terminals on the volume control to the positive terminals on the amplifier and speakers, and connect the negative terminals on the volume control to the negative terminals on the amplifier and speakers. See **Figure 3**. To help you avoid improper phasing, the connector plug is keyed. Insert the smooth side of the connector plug into the smooth side of the socket. Don't force*

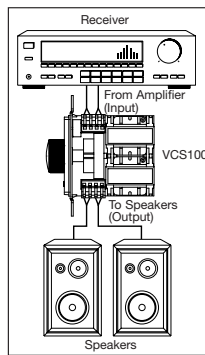

Figure 3
Wiring Diagram

*the scalloped side of the connector plug into the smooth side of the socket. See **Figure 6**.*

5. Set the Impedance Magnification Switch (See **Figure 7**) as determined by the IM charts (**Figures 4** and **5**).

6. Plug the connectors into the volume control as shown in **Figure 6**. The inputs of the IM volume control are the connector pins labeled AMPLIFIER. The outputs are the connector pins labeled SPEAKERS.

NOTE: *If you reverse these connections, the volume control won't function properly.*

7. Secure the volume control to the junction box. Insert the 1-1/4" device screws into the oblong screw holes on the top and bottom of the volume control. The oblong shape of the screw holes helps you place the volume control in a vertical position. Align the screws with the threaded holes in the junction box. Tighten the screws using a Phillips screwdriver. **DO NOT OVERTIGHTEN.** If necessary, loosen these screws several turns so the volume control fits flush with the faceplate.

8. Use the shorter plate screws to fasten the Decora faceplate to the volume control.

10. Align all the screws in the same direction for a clean, finished look.

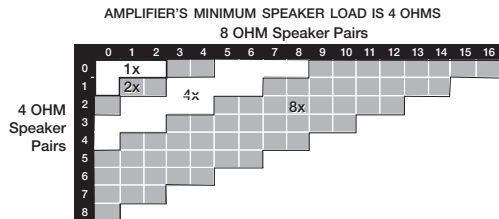

Figure 4

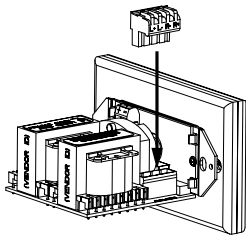

Figure 6

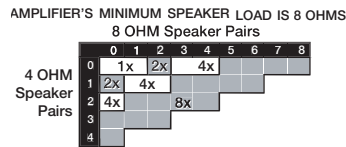

Figure 5

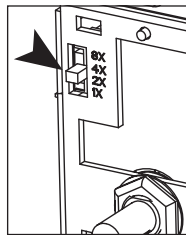

Figure 7

OPERATION

1. Make sure the amplifier or receiver power is OFF and set the volume to minimum.
2. Set the volume on the volume control to maximum (fully clockwise).
3. If you are using a Niles speaker-selection system, locate the ON/OFF button that corresponds to the speaker pair you wish to play. Set it to the ON position. Make sure the defeatable protection circuit is not enabled. See *Using Speaker Selectors with IM Volume Controls*, on page 3.
4. Turn ON the amplifier or receiver and select a source, such as the tuner or CD player.
5. Slowly turn up the amplifier or receiver volume and set it to a comfortable – *not maximum* – listening level. Don't overdrive or "clip" your amplifier. If the sound becomes muddy or distorted, you have reached the limit of your amplifier's volume capability. Reduce the volume at once to avoid damaging your speakers.

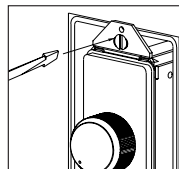

Figure 8
Loosening the
Screws for a Flush Fit

6. Use the volume control to adjust the volume of the speakers to the desired listening level. If all the speaker pairs in your system are equipped with Niles volume controls, you can set the amplifier or receiver volume at one position and use the Niles controls exclusively.
7. To turn OFF the speakers, turn the knob on the volume control fully counter-clockwise, or press the ON/OFF button on your speaker selector.

MAINTENANCE

Niles volume controls do not require any regular maintenance other than occasional cleaning. Use a damp soft cloth and simply wipe the knob and wallplate clean. Do not use an abrasive cleanser as this might scratch the surface of the wallplate.

TECH TIP

When using a receiver, set all of your IM volume controls at maximum volume. Then turn up the master volume on the receiver until you reach the maximum listening level. Finally, turn down the volume controls.

SPECIFICATIONSAudio Power Handling

100W/channel RMS

200W/channel peak music power

Mounting

In-wall, fits into most 18-cubic-inch single-gang junction boxes at least 2-3/4" deep

Wiring Requirements

14-16 gauge, two individual runs of two-conductor speaker wire, or one run of four-conductor speaker wire.

Unit Dimensions

1-5/8" wide x 2-5/8" high

Faceplate Dimensions

Faceplate: 2-3/4" wide x 4-1/2" high

Depth Behind Faceplate

2-9/16"

CONTENTSVCS 100R

- VCS 100 volume control
- Snap-on Decora color insert
- Decora wallplate
- Standard wallplate
- Knob
- Device mounting screws X2
- Faceplate screws X2
- Removable speaker connector X2

VCS 100

- VCS 100 Volume Control
- Snap-on Decora color insert
- Knob
- Device mounting screws X2
- Removable speaker connector X2

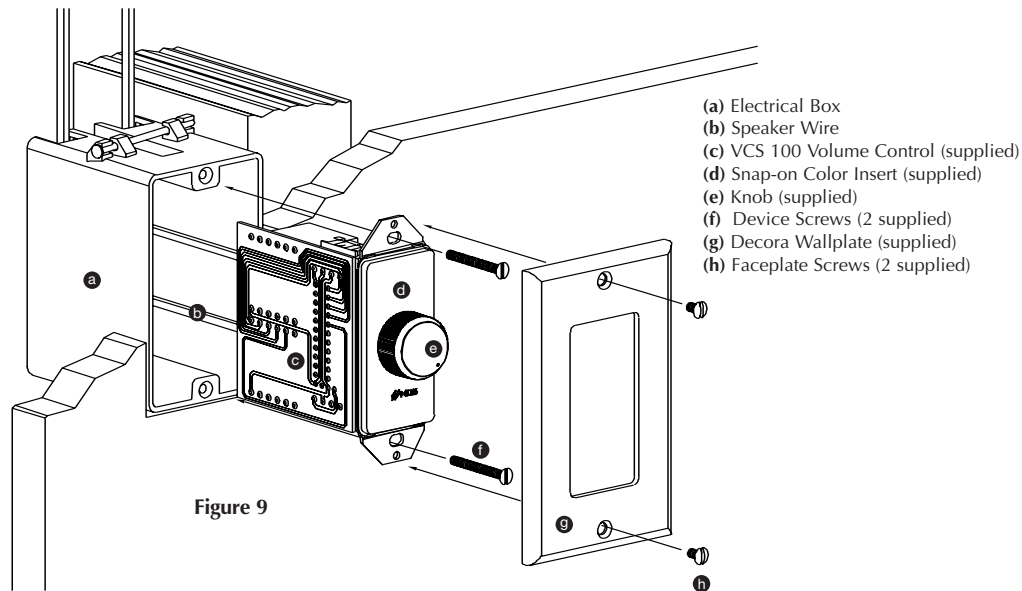

Figure 9