

INSTALLATION & OPERATING INSTRUCTIONS

READ & SAVE IMPORTANT SAFETY INSTRUCTIONS

Please read and understand this entire manual before attempting to assemble, operate or install this product.

1. This product must be installed in accordance with any applicable installation code(s) by a qualified electrician or person familiar with the construction and operation of the product and the hazards involved.
2. **RISK OF FIRE OR ELECTRIC SHOCK :** The electrical rating of this product is 120VAC.
3. **WARNING -RISK OF FIRE OR ELECTRIC SHOCK:** Install this product only in luminaires that have the construction features and dimensions shown in this manual.
4. **WARNING -** To prevent wiring damage or abrasion, do not expose wiring to edges of sheet metal or other sharp objects.
5. **Do not make or alter any open holes in an enclosure of wiring or electrical components during installation.**
6. **THIS DEVICE IS NOT INTENDED FOR USE WITH EMERGENCY EXITS**
7. **DANGER-RISK OF SHOCK-DISCONNECT POWER BEFORE INSTALLATION**
8. **WET LOCATION LISTED, ACCEPTABLE IN SHOWER INSTALLATIONS.**

- Suitable for Type IC Housings
- Suitable for Type Non-IC Housings

CAUTION: to avoid possible electrical shock, be sure that power supply is turned off at fuse box or circuit breaker before installing or servicing fixture. For your safety, read and understand instructions completely before beginning installation.

PACKAGE CONTENTS

Before beginning installation of this product, make sure all parts are present. Compare parts with package contents list and diagram as below. If any part is missing or damaged, do not attempt to assemble, install or operate this product.

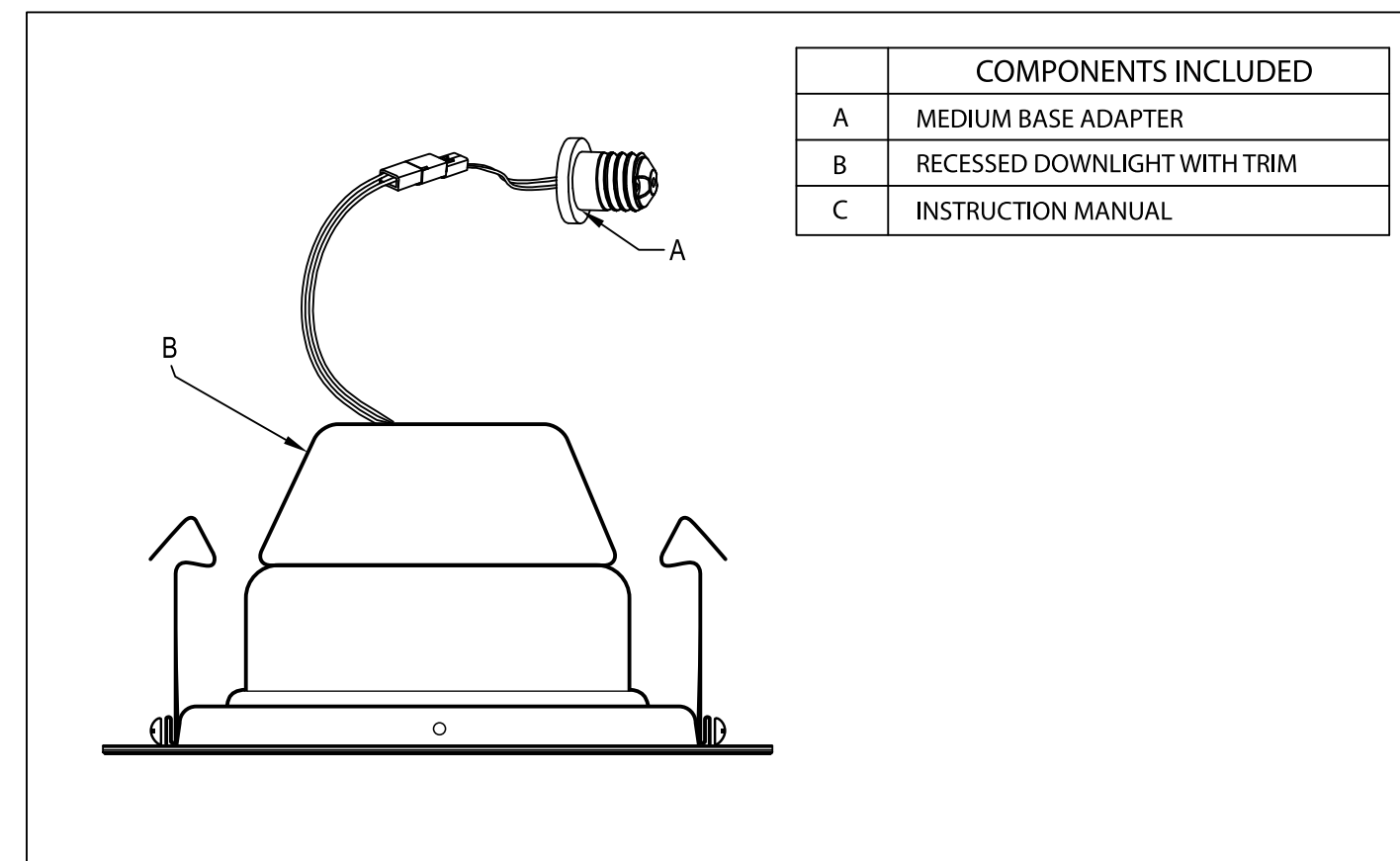

General wiring configuration

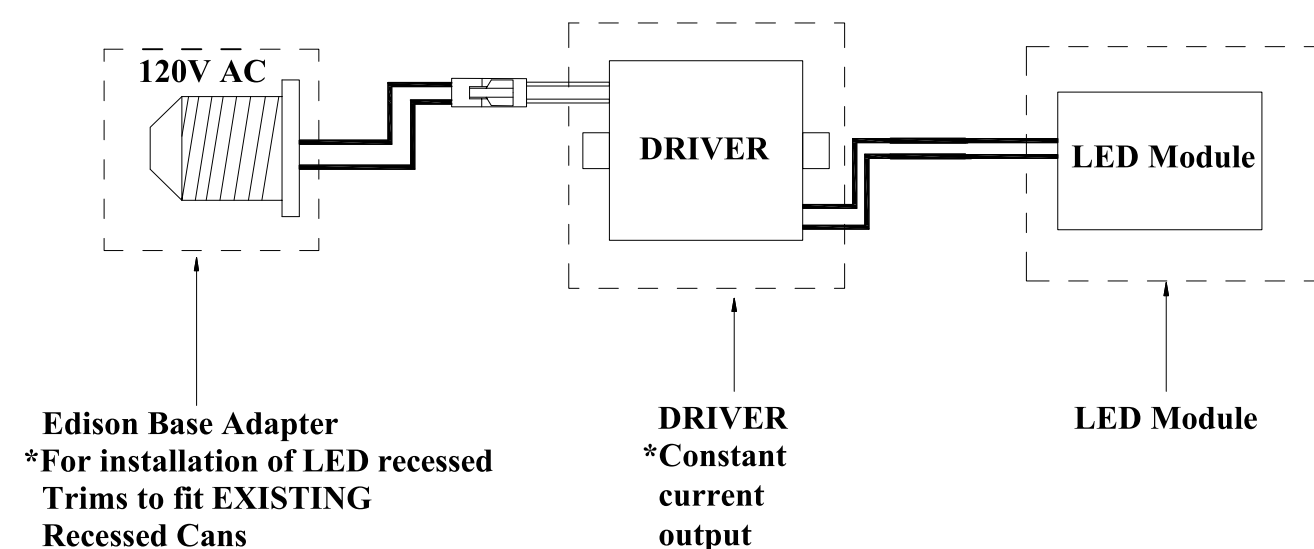

1. Installation into Existing Recessed Incandescent Fixture: For use with 4" recessed housings (housing sold separately)

LED recessed trim will fit into select existing 4" nominal incandescent housings.

- Step 1. Turn OFF power at switch and fusebox or circuit breaker.
- Step 2. Remove existing trim installed in recessed housing (if necessary).
- Step 3. Install adapter into socket (see FIG. 2).
- Step 4. Connect the two terminals together (see FIG. 3).
- Step 5. Gently push trim into place (see FIG. 4).

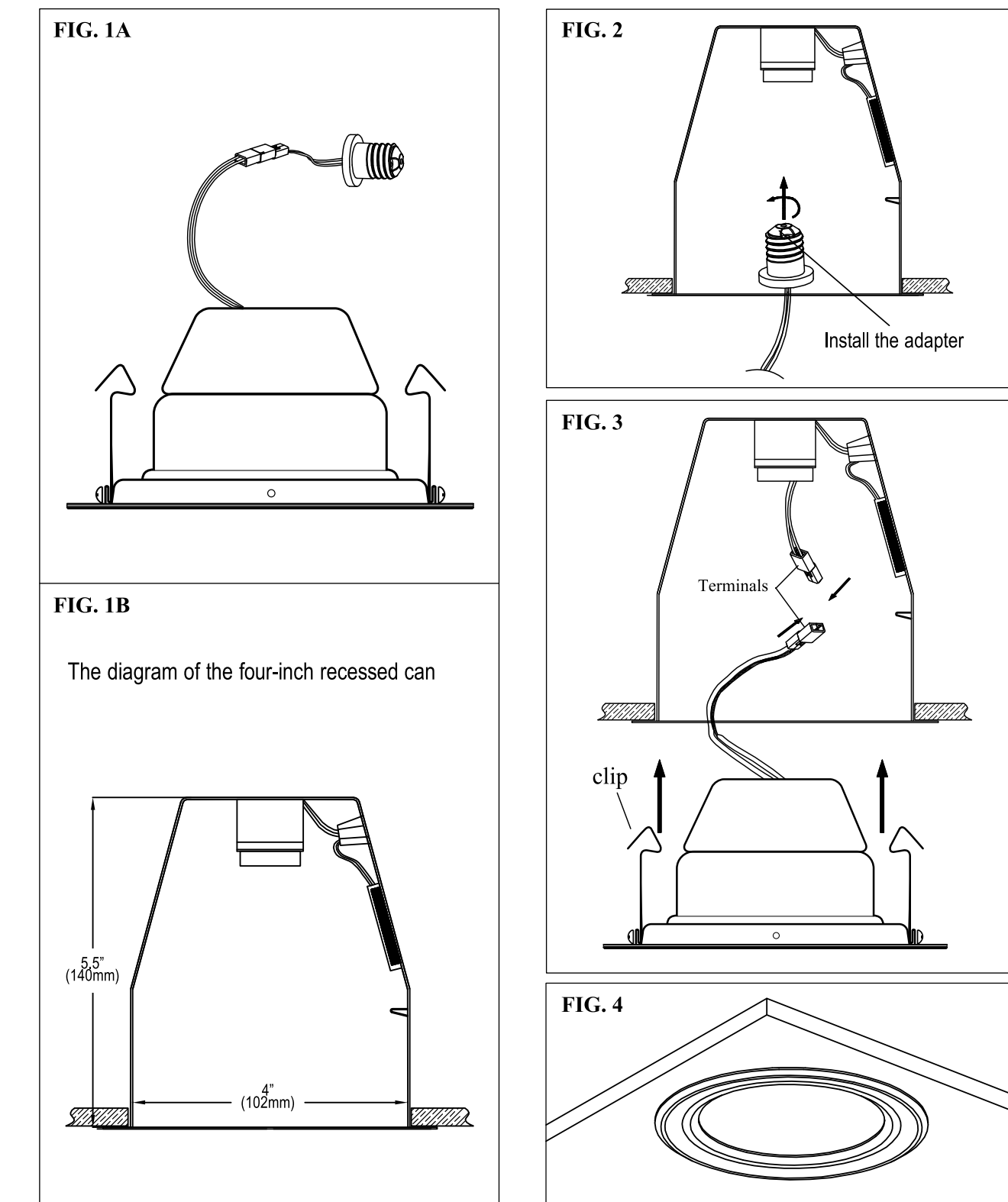

WARNING – Risk of fire or electric shock. LED Recessed Downlight with Trim installation requires knowledge of luminaires electrical systems. If not qualified, do not attempt installation. Contact a qualified electrician.

WARNING – Risk of fire or electric shock. Install this product only in the luminaires that have the construction features and dimensions shown in the photographs and/or drawings.

Do not make or alter any open holes in an enclosure of wiring or electrical components during installation.

WARNING – To prevent wiring damage or abrasion, do not expose wiring to edges of sheet metal or other sharp objects.

MIN. LAMP COMPARTMENT DIMENSIONS: 102mm (4") DIA X 140mm (5.5") HEIGHT

PRODUCT ELECTRIC RATING

INPUT VOLTAGE / FREQUENCY	INPUT CURRENT	INPUT POWER
120V/60Hz	XXmA	10.3W

LIGHTING DISTRIBUTION		
	Center Beam (Foot Candles)	Beam Diameter
3 ft	39	6.9 ft
5 ft	14	12 ft
8 ft	5.5	18 ft
15 ft	1.6	35 ft

Beam Angle = 98.2°