

USER'S MANUAL

BV9370B

BLUETOOTH® | MP3-COMPATIBLE DIGITAL MEDIA AM/FM RECEIVER

BOSS[®]
AUDIO SYSTEMS

BOSS Audio Systems

3451 Lunar Court • Oxnard, CA 93030

www.bossaudio.com

800-999-1236 US Toll-free

805-751-4853 Customer Service

Tech Support: www.bossaudio.com/support/technical-support



0518

iPod® / iPhone® are trademarks of Apple, Inc. registered in the U.S. and other countries.
BOSS Audio Systems is not affiliated with Apple, Inc.
The Bluetooth® word mark and logos are registered trademarks owned by Bluetooth SIG, Inc. and any use of such marks by BOSS Audio Systems is under license.
Other trademarks and trade names are those of their respective owners.

USER'S MANUAL

BV9370B

BLUETOOTH®

MP3-COMPATIBLE DIGITAL MEDIA AM/FM RECEIVER

FEATURING 6.5" (165 mm) WIDESCREEN TOUCHSCREEN

DIGITAL TFT LED MONITOR



BOSS[®]
AUDIO SYSTEMS

**To ensure safety while driving
and to comply with laws,
drivers should not watch video or
operate the video device while driving.**



Congratulations on your purchase of a Boss Audio Systems Multimedia Receiver. It has been designed, engineered and manufactured to bring you the highest level of performance and quality, and will offer you years of entertainment pleasure.

Content

Accessories	02
Unit Installation.....	03
Wire Connection.....	03
Parking Brake Connection	04
Speaker connection.....	05
Button Description.....	06
Remote Control.....	07
Main Menu.....	09
Radio Operation.....	09
USB /SD Operation.....	10
Settings Operation	10
Bluetooth Operation.....	12
Aux-In Operation	13
Troubleshooting	15
General Specification.....	16

Accessories

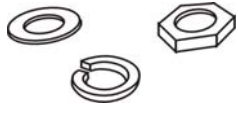
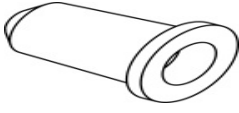
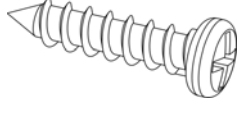
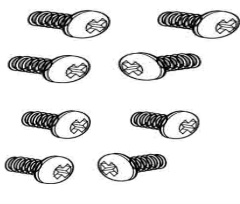
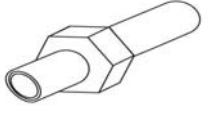
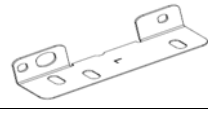
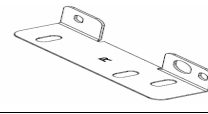
Package contains the following accessories for installation and operation of the unit.

(1) Washer, Spring (2) Washer, M5 Nut	1		(5) Rubber Cushion	1		
(3) Screw	1		(6) Screw	8		
(4) Bolt	1		(7) installation bracket	1	Left	
				1	Right	
(5) Mounting Strap	1					

Remote Control



Power Cable

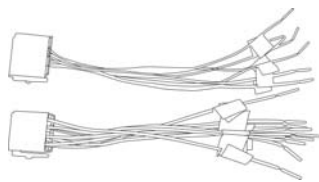

Trim Ring



User Manual

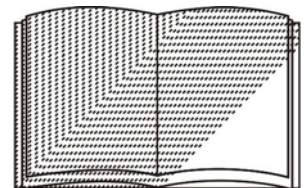

Unit Installation

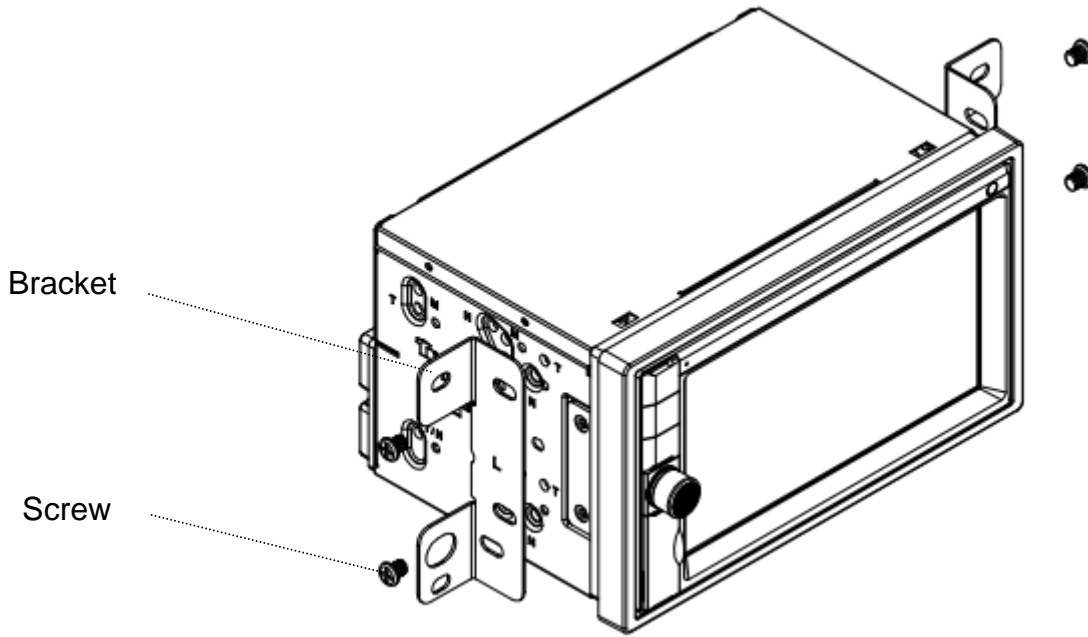

1. Put the 2 brackets to the left and right side of the unit;
2. Use screws to fix the brackets to the unit.

Wire Connection

The Description of the Input/output Interface of the Rear Chassis.

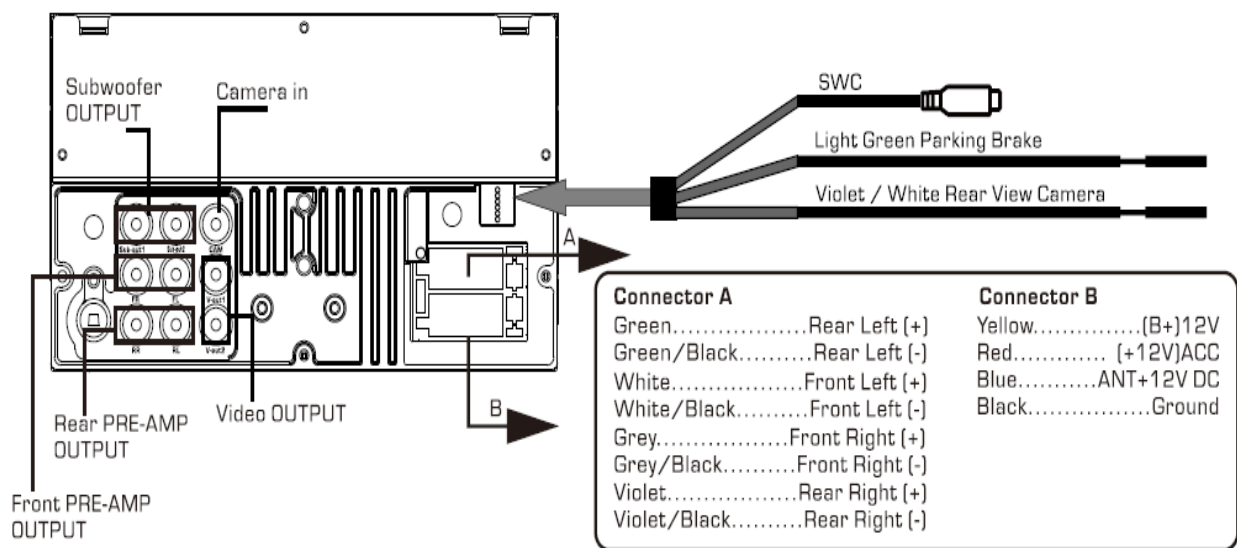

Parking Brake Connection

In order to view videos, the parking brake wire must be connected, and the vehicle is parked

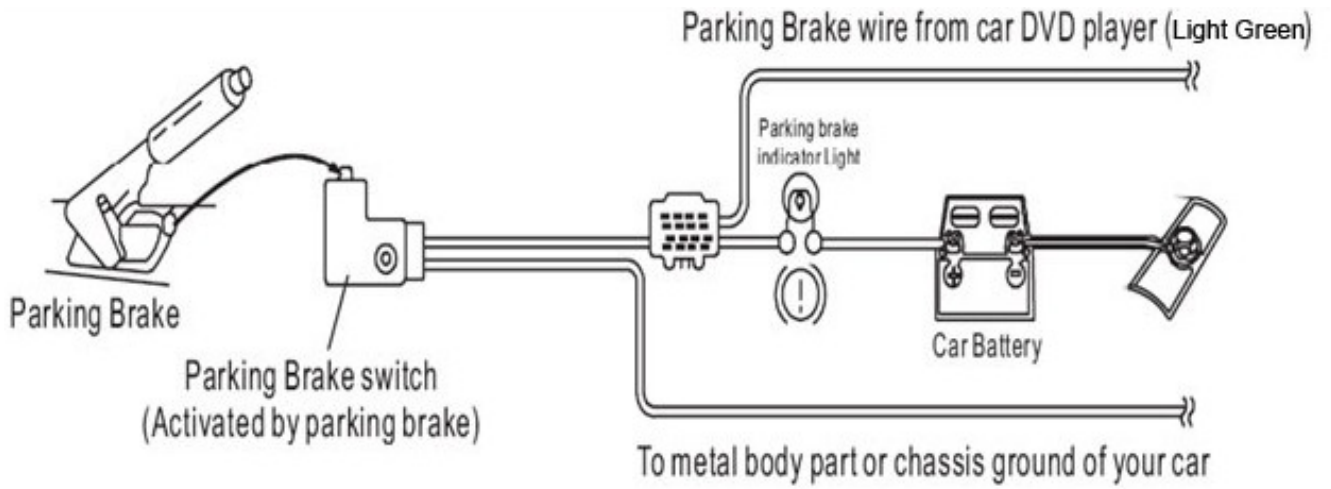

Connecting the reversing line to taillight on the car

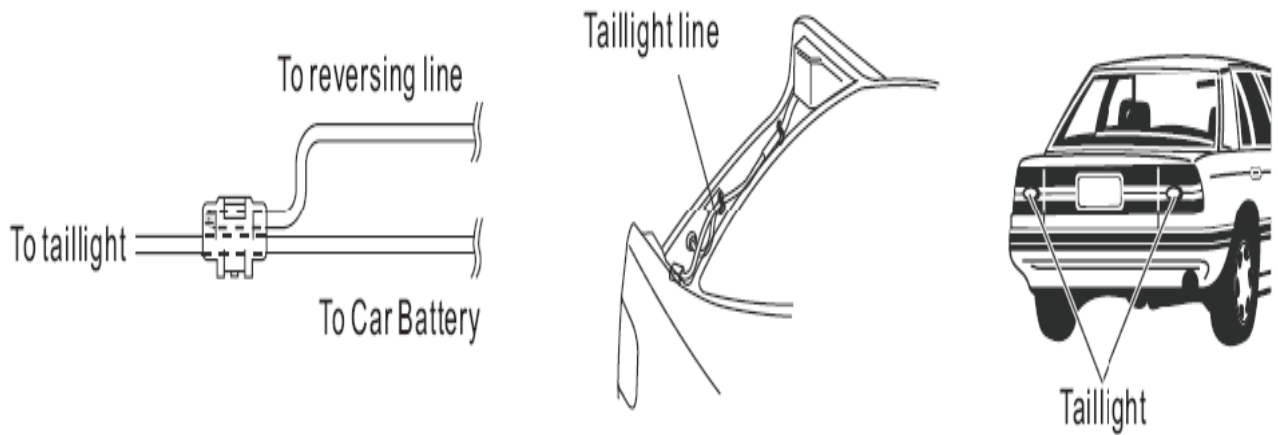

Speaker Connection

Connect the speakers according to the following diagram, incorrect connections may damage the unit or your speakers. Do not chassis ground the speakers. Always observe correct polarity.

Correct connection

Left front - Right front | Left rear - Right rear

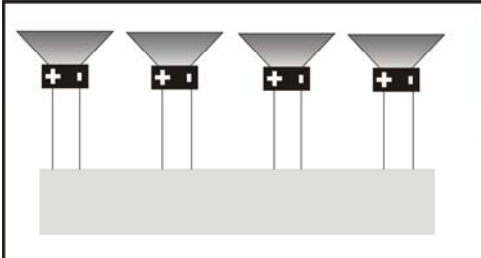

Incorrect connections

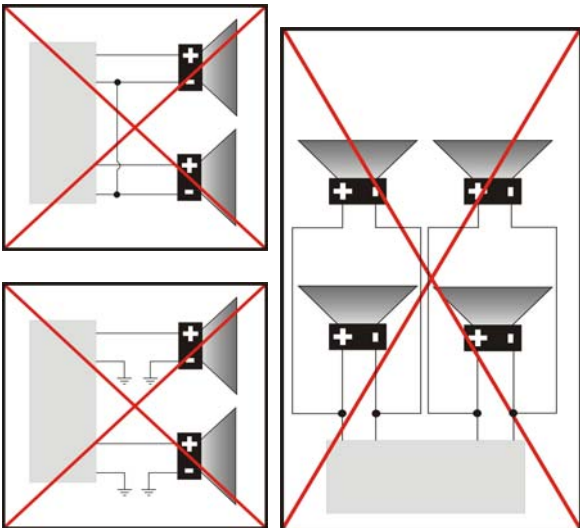

Button Description

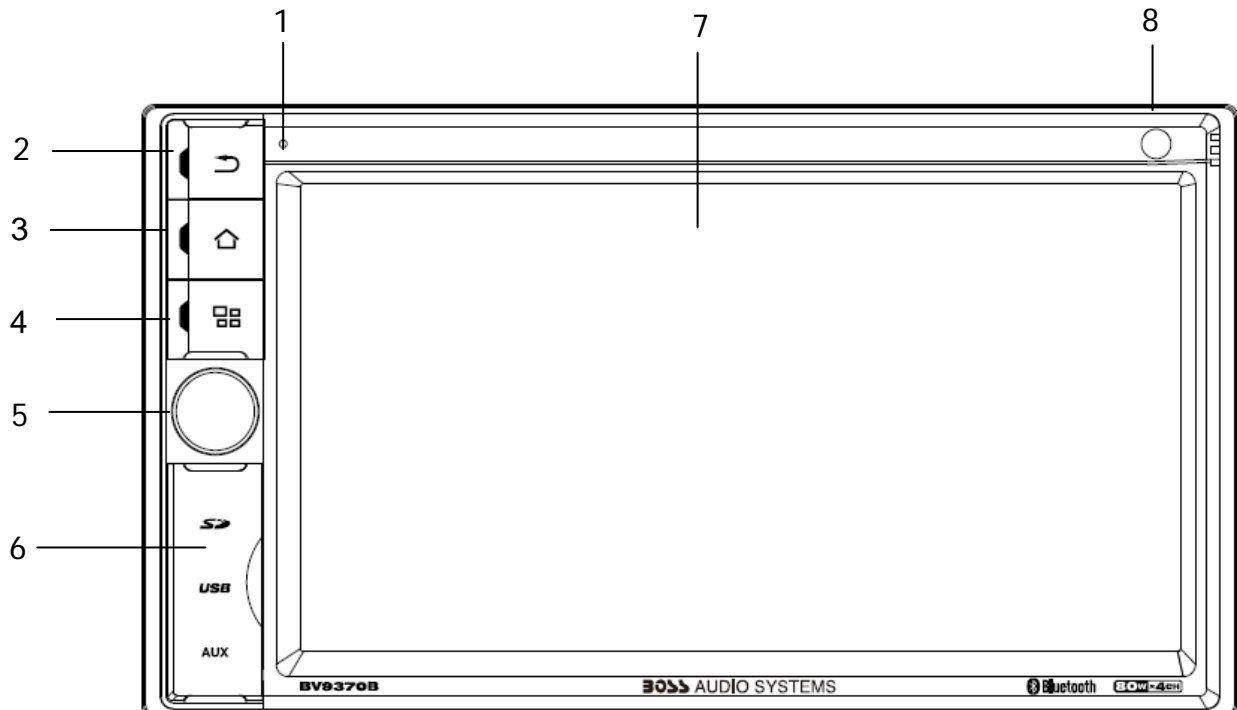

1. MIC

2. RETURN Button

Press it back to main previous menu.

3. HOME BUTTON

Press home button to return back to main menu.

4. SOURCE BUTTON

Press source button to change mode.

5. POWER / MUTE Button /VOL

Press it to turn on the unit. Press and hold for 2 seconds to turn the unit off .Press the button. briefly to mute .Please notes that the volume will be muted on all audio output connector.

Press VOL knob to power on unit and Press and hold for 2 seconds to turn the unit off

Rotate VOL knob to increase or reduce the volume.

6. USB/SD/AUX

USB for Multimedia playback files only. insert a USB into this slot and the unit will automatically start reading and playback. * Supported Music File Format: MP3, WMA files.

SD card slot, for Multimedia playback files only. Insert a SD CARD into this slot and the unit will automatically start reading and playback. * Supported Music File Format: MP3, WMA files

Put the Aux plug into the Aux-In jack which was marked on front panel.

7. Display

Display Information when operation the unit.

8. Remote Sensor

Remote control signal receiving window. Max distance is 20 ft (6m), 45 deg.

Remote Control

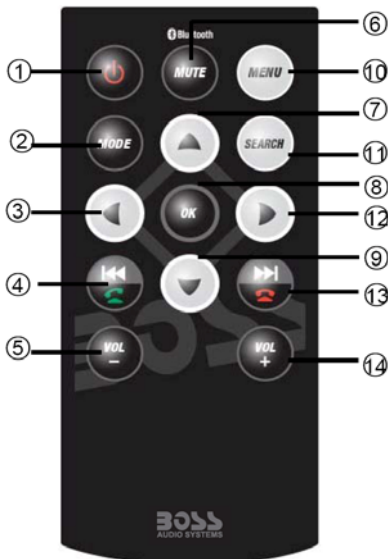

- 1: POWER
- 2: MODE
- 3: LEFT
- 4: PREVIOUS/Accept
- 5: VOLUMN DOWN
- 6: MUTE/BLUETOOTH
- 7: UP
- 8: OK
- 9: DOWN
- 10: MENU
- 11: SERARCH
- 12: RIGHT
- 13: NEXT/REJECT
- 14: VOLUMN UP

1. POWER button

Power on or power off.

2. MODE button

Press it to select the mode: Radio, USB (if there is a USB device in the unit), SD (if there is a SD/MMC card in the unit), Bluetooth, Aux-In.

3. LEFT button

Press it to move the cursor left.

4. ⏮ / ACCEPT

In USB, SD mode, press ⏮ button to skip to the previous track, press and hold ⏮ button for two seconds to activate fast reverse (REW) search in a track.

In Radio mode, press and hold ⏮ button to select station backward automatically, touch again will stop select station. ⏮ button frequency down.

In Bluetooth mode, press to make a call after inputted a phone number or accept an incoming call.

5. VOLUME DOWN button

Press to decrease volume level.

6. Mute button/Bluetooth button

Short press to mute the volume output, press again to resume volume.

Long press this button to enter into Bluetooth mode (Handsfree).

7. UP button

Press it to move the cursor up.

8: ENTER

Press it to confirm your selection.

9. DOWN button

Press it to move the cursor down.

Remote Control

10. MENU

Press it to show main menu.

11. SEARCH button

Press it to search the radio station automatically.

12. RIGHT button

Press it to move cursor right.

13. NEXT/REJECT button

In USB, SD mode, press ►► button to skip to the next track, press and hold ►► button for two seconds to activate fast forward (FF) search in a track.

In Radio mode, press and hold ►► button to select station forward automatically, touch again will stop select station. ►► button frequency up.

In Bluetooth mode, press to reject a call.

14. VOLUME UP button

Press to increase volume level.

Note:

- The distance may vary according to the brightness of ambient light.
- If the remote is not used for an extended period of time, remove the battery to prevent possible damage from battery leakage and corrosion.
- Do not place any objects between the remote control unit and the sensor on the unit.
- Do not drop the remote control onto the floor; it will damage it beyond repair.
- Do not use the remote control unit, while simultaneously operating the remote control unit of any other equipment; they may interfere resulting in improper operation.
- The battery normally last for about one year although depending how often the remote control is used. If the remote control unit isn't working even when it is operated near the unit, replace the battery with a new battery of the same make and use only a lithium cell battery type: CR2025 (3V).
- Dispose empty batteries in accordance with your local governmental regulations.
- Do not short-circuit, disassemble, heat or dispose of fire or flames the battery.
- Keep the battery out of reach of children, should the battery be swallowed, immediately consult a doctor.

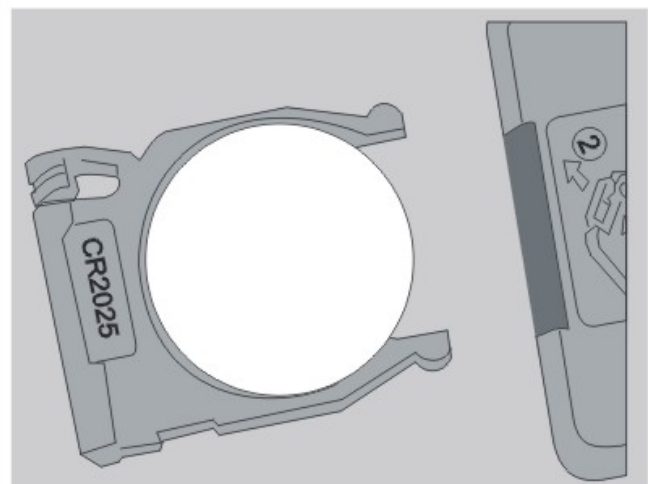
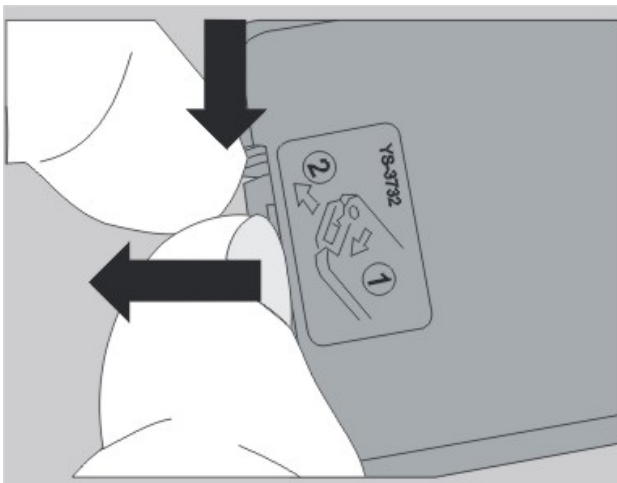

Main Menu

The best way to discover the program is to explore each screen in detail, and to find out how to move from one to another. Read this chapter for a guided tour.

Unit starts by displaying the main menu.

This is the root of the screen hierarchy, and you can simply access all features by tapping on the touch screen buttons.

Tap the icons to enter a desired mode. Swipe the screen left and right to switch between the 2 menu pages.



Page 1













Page 2

Radio Operation

To start radio, tap radio button on main menu screen.



-  Touch it to select station backward manually, touch and hold this icon to select station backward automatically.
-  Touch it to select station forward manually, touch and hold this icon to select station forward automatically.
-  Touch it to select FM1—>FM2—>FM3.
-  Touch it to select AM1—>AM2.
-  Long Touch it to select station forward automatically. Touch again will stop select station.
-  Long Touch it to select station backward automatically. Touch again will stop select station.
-  Touch this button can turn on or turn off Local function.
-  Touch this button to select mono sound reception.
-  Touch this button can scan the stations from 1-6, Long Touch it to save the stations with good reception automatically and scan each station for about 5 seconds.
-  Touch this button to adjust the brightness of TFT panel.

USB/SD Operation

When a file of USB or SD card is played (music, video, photo), the screen will show following interface:



Press it to repeat REP 1 => REP DIR => REP ALL



Press it to skip to the previous track.



Play/pause button.



Press it to skip to the next track.



Press it to play track randomly



Rotate the image in the sequence of $\times 90 \times 180 \times 270 \times 360$



Zoom the image in or out in the sequence of $\times 2 \times 3 \times 4 \times 5 \times 1/2 \times 1/3 \times 1/4$



Press it to show all file



Press it to play video

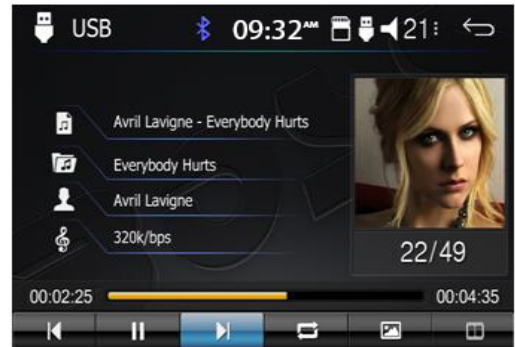

Settings Operation

Setting Control

Your device has default system setting, you can customize the settings to suit your personal needs. Once you change settings, your new settings will remain until you change it again. To start setting, tap it on main menu.

General Control



Tap Panel Adjust button to setup panel touch



OSD Language	: select English /Spanish
Wallpaper	:select and change the wallpaper setting
Subwoofer	: set Subwoofer on or off
Radio Area	:select radio area, from Europe— USA— South America—Russian— Asia
Clock	:setting the clock
SWC	: program Steering Wheel Control
Key Beep	:set beep sound on or off
Standby Display	:set standby display on or off
Version	: just show you the firmware version
Restore Default	

press button on the panel and then tap the center of the to adjust .when finish the adjust,it will automatically go back to the UI.

Settings Operation

Tap SWC item to program SWC



Tap Wallpaper button to setup wallpaper



- 1) First check whether the car has steering wheel button.
- 2) The steering wheel and the unit must be connected on the line.
- 3) While holding down the button on the steering wheel and the corresponding button on the SWC interface it will display complete setting. When all the buttons on the steering wheel and the corresponding button on the SWC interface complete setting, you can use the steering wheel button to operation the unit, such as in radio mode, press **⏮** button or **⏭** button to search station backward or forward.

Note:

1. The "Enter" button and the "reset" button are not included in steering wheel, press the "enter" button to confirm the select, press the "reset" button to clear the former select.
2. The restriction of use SWC is the voltage between the adjacent buttons are above 0.2V that can be identified.

Sound Control

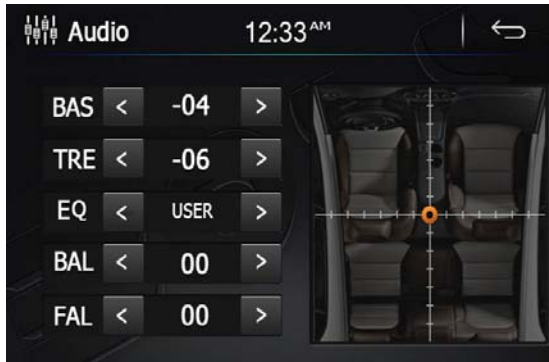

Sound Effect
Subwoofer
Loudness : select on/off
Loud Cut off Freq:

EQ : select User—Classic—Rock—Pop—Jazz—Electric—Flat
Reset

Subwoofer

Connect the subwoofer to the unit using sub output (see electrical diagram), tap menu on screen enter into main menu setting choose setting menu. choose sound and set subwoofer on to enable subwoofer.

Parking

When the car is stopped and the parking brake is working, the screen can display the video image, otherwise the screen can't display the video image.

Rear View Camera

This unit is equipped with Rear View Camera output. The camera is used to observe the situation behind the vehicle when you are backing the car. Please connect your Rear View Camera with the back car video input. And connect the reverse wire for back a car with the rear gear light. Rear View Camera picture will be enabled when you are backing the car.

Bluetooth Operation

Warning: Driving and having a telephone conversation at the same time is dangerous, please park your car before having a telephone conversation. The supplier waves any and all liability when this warning is not followed.

Bluetooth section

To enter bluetooth mode, you can tap  bluetooth icon on main menu or long press the mute/bluetooth button on the remote control or press mode button on remote.

Pairing Mode

At the 1st time when using bluetooth, you need to pair the mobile phone first.

When a phone has not been paired with the unit, the BT icon and pairing mark will blink continually on the panel.

When the unit have connect with phone, the BT icon will turn on and the mobile phone name (if available) will be display on the panel.

According to mobile pairing device manual, after searching new device (BT friendly name: Boss Audio BV9370B) select it, input password "0000" and confirm ok, device paring is finished.

The phone name will available on the panel after the pairing is completed. It means device is connected and ready for bluetooth communication.

Tap  can see call history.

Tap  calling key pad menu to make a call.

Tap  calling button to use phonebook functions.

Tap  to connect bluetooth.



calling button

Tap  button to enter call mode.

In call mode, the unit can be used as your phone, making and receiving calls are possible with

bluetooth, simply tap phone number and tap  button to accept a call, and tap  button to hang up.





1) Tap the  button for 3-4 seconds, the device automatically makes a call to the latest call in its call log.

2) The volume will be operated separately while calling.

Calling History

Tap  button can see call history .

After the unit be allowed download the data from phone.

Tap  button can see the call records of which have been received , tap  button can see the call records of which have been dialed , tap  button can see the call records of which have been missed , Tap the  button to dial the number you chose.

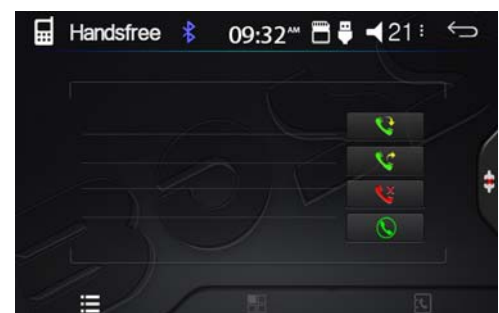

Bluetooth Operation

(A2DP) Streaming Music Mode



Tap  music streaming icon on main menu enter to listen music .

Tap  button to played and paused 'music' in bluetooth mode.

Tap  and , you can select the function with the key for previous and next.

A2DP (Advanced Audio Distribution Profile) Music Player

A2DP is a function which can receive the audio frequency signal from the mobile phone, amplified by the car audio and played out by the car speakers.

Notice: your mobile phone need to support A2DP.

Tap the buttons on the screen as shown, or press corresponding buttons (pause/play, stop, previous/next) on remote control to play, pause, play previous, or next music file.

Aux-In

Aux-In MODE

To start Aux-In Mode, tap Aux-In icon from main menu screen. connect the external audio signal source to this unit will display "NOW PLAYING".

Note: Aux-In does not support a video display function. So, there is "NO SIGNAL DETECTED" displayed if no audio signal input. Press  the icon to be back to main menu.

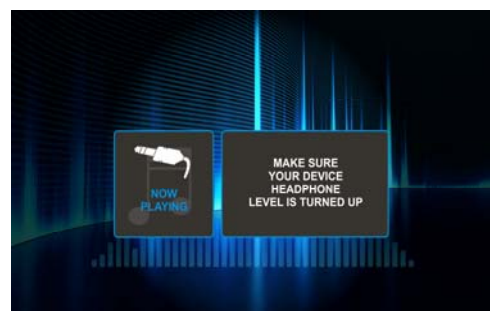
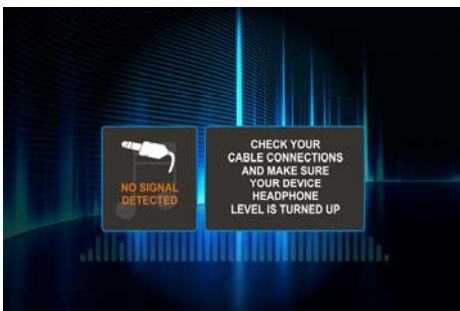

Troubleshooting

	Symptom	Cause	Remedy
General	Power does not turn on (No sound is produced)	Fuse is blown	Replace with fuse of the same amperage. If the fuse blows again, consult your store of purchase
		Incorrect wiring	Consult your local retailer
	No sound output when operating the unit with amplifiers or power antenna attached	Power antennal lead is shorted to ground, excessive current is required or remote on the amplifiers or power antenna	<ol style="list-style-type: none"> 1. Turn off the unit 2. Remove all wires attached to the power antenna lead, check each wire for a possible short to ground using an ohm meter 3. Turn on the unit 4. Reconnect each amplifier remote wire to the power antenna lead one by one. If the amplifiers turn off before all wires are attached, use an external replay to provide remote-on voltage (excessive current required)
	Nothing happens when buttons are pressed Display is not Accurate	Unit needs to be Reset	Using a pen or toothpick, press and release the Reset button.
		Panel or main unit Connectors are dirty	Wipe the dirt off with a soft cloth moistened with cleaning alcohol

Troubleshooting

symptom	Cause	Solution
No power	The car ignition is not on	If the power supply is properly connected to the car accessory switch the ignition key to "ACC"
	The fuse is blown	Replace the fuse
No sound	Volume is in minimum	Adjust volume to a desired level
	Wiring is not properly connected	Check wiring connection
The operation keys do not work	The built-in microcomputer is not operating properly due to noise	Press the power button for about 10 seconds to reset the unit
	Front panel is not properly fix into its place	
Sound skips	The installation angle is more than 30 degrees	Adjust the installation angle to less than 30 degrees
	The disc is extremely dirty or defective	Clean the compact disc/try to play a new one
The radio does not work, the radio station automatic selection does not work	The antenna cable is not connected the signals are too weak	Insert the antenna cable firmly select a station manually

General Specification

General	
Power supply	11~16V DC
Current consumption	Max. 10 A
Maximum power output	80W x 4 channels (max)
Compatible formats	MP3,WMA,JPEG,AVI
Dimensions (W x D x H) / weight	6.5" x 7.0" x 3.9" /4.15 lbs
Working temperature range	-4°F -- +140°F
TFT display	
Screen size	6.5 inch
Resolution	800*480 pixel
Aspect ration	4:3/16:9
Brightness	460 cd/m ²
Contrast ratio	500:1
FM radio	
Frequency range(Europe area)	FM:87.5 –108MHz(Step 50KHz)
Frequency range(America area)	FM:87.5 –107.9MHz(Step 200KHz)
Frequency range(Asia area)	FM:87.5 –108MHz(Step 100KHz)
Frequency range(South America area)	FM:87.5 –108MHz(Step 100KHz)
Frequency range(Russia area)	FM:87.5 –108MHz(Step 50KHz) 65-74MHz(Step 30KHz)
Preset memory stations	18
AM(MW)radio	
Frequency range(Europe area)	AM:522-1620(Step 9KHz)
Frequency range(America area)	AM:530-1710(Step 10KHz)
Frequency range(Asia area)	AM:531-1602(Step 9KHz)
Frequency range(South America area)	AM:520-1710(Step 10KHz)
Frequency range(Russia area)	AM:522-1620(Step 9KHz)
Preset memory stations	12
Audio specification	
Frequency response	20 Hz-20 KHz
TV Color System	Color system NTSC/PAL
USB interface	
USB type	USB 2.0 full speed

Specifications are subject to change without notice, mass and dimension are approximate.