

88 5020 80

Monarch Dining Chair

IMPORTANT NOTE

Carefully remove all the parts from the carton and put them individually on a soft cloth to prevent scratches or other damages occurring to the parts.

We have taken great care in the design of this product and request that you carefully and strictly follow our assembly instructions to ensure a completed product as it was designed.

Home Styles

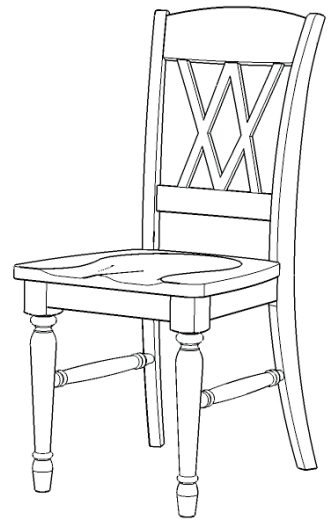

Part List

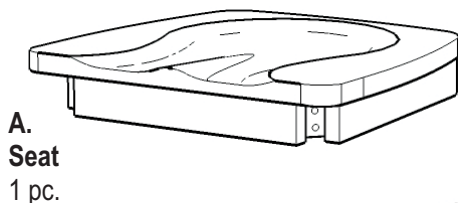

A.
Seat
1 pc.

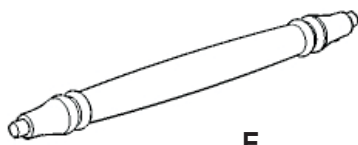

E.
Side Stretcher
1 pc.

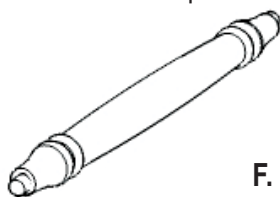

F.
Side Stretcher
1 pc.



B.
Leg
1 pc.



C.
Leg
1 pc.

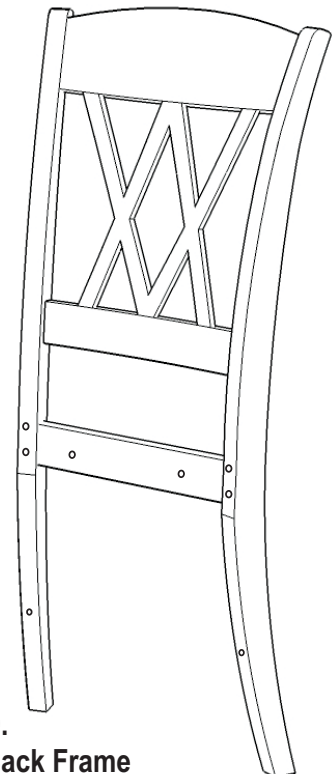

D.
Back Frame
1 pc.

Hardware List



Key Wrench
1 pc.

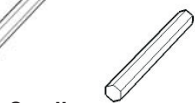

Small Hex Wrench
1 pc.



Wood Screw
4 pcs.(+1 extra)



Head Cap Bolt (long)
4 pcs.(+1 extra)



Head Cap Bolt (Short)
3 pcs.(+1 extra)

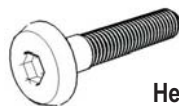

Head Cap Bolt
4 pcs.(+1 extra)



Flat Washer
11 pcs.(+1 extra)



Spring Washer
11 pcs.(+1 extra)

Tools required for assembly : **Phillips** screwdriver

Home Styles Consumer Assistance Line 888-680-7460 and 877-831-0319
servicedesk@homestyles-furniture.com

Assembly Instructions

IMPORTANT

* Do not tighten up all the screws until each part is properly assembled.

* You should keep Hex Wrench in a safe place as you may need to tighten up the Head Cap Bolts in the future.

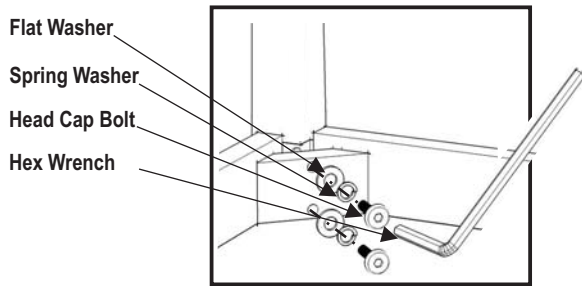

Head Cap Bolt Assembly
(Legs Part)

STEP 1

Attach Leg (B) and (C) to Seat (A) with Flat Washers, Spring Washers and Head Cap Bolts.

Tighten Head Cap Bolts only half way.

Attach Side Stretcher (F) to Leg (C) and Side Stretcher (E) to Leg (B) with Wood Screws. (see Figure 1)

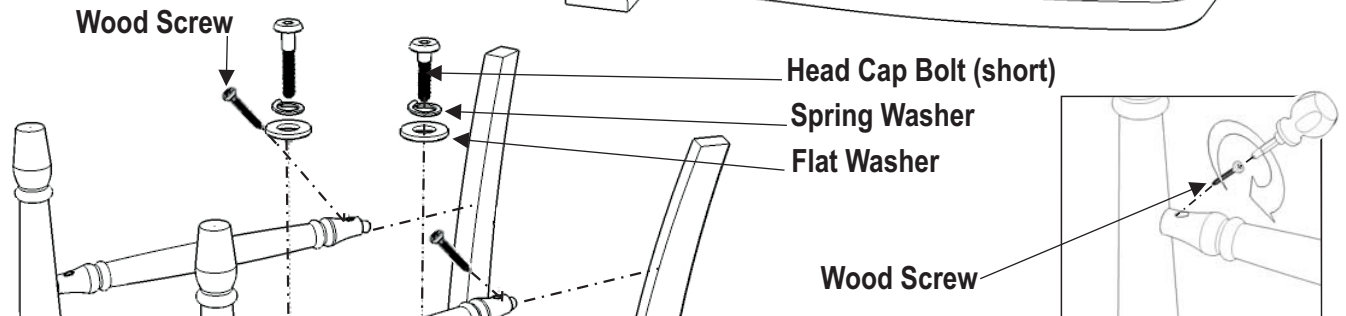
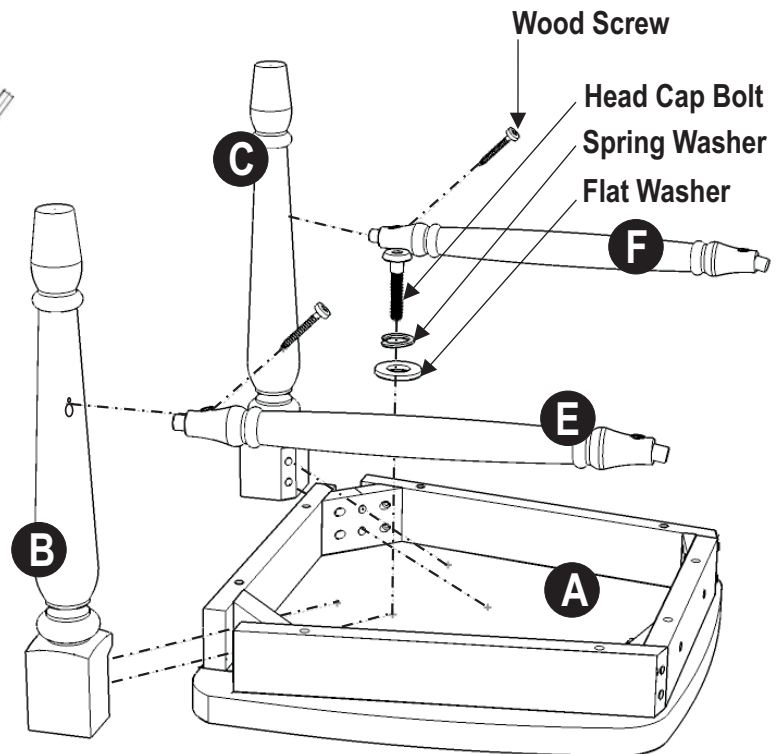

Figure 1

STEP 2

Attach the Back Frame (D) to the unit with Flat Washers, Spring Washers, Head Cap Bolts (Short), Head Cap Bolts (long) and Wood Screws. (see Figure 2) and (see Figure 3)

Tighten all Head Cap Bolts.

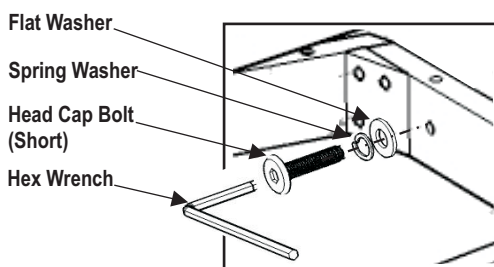

Figure 2

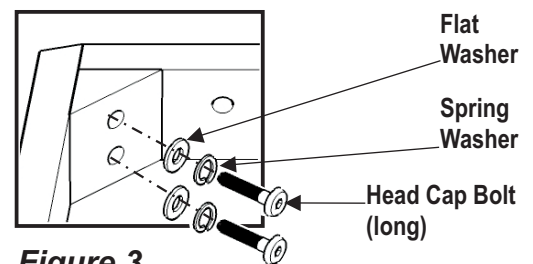

Figure 3