

# INSTRUCTION MANUAL

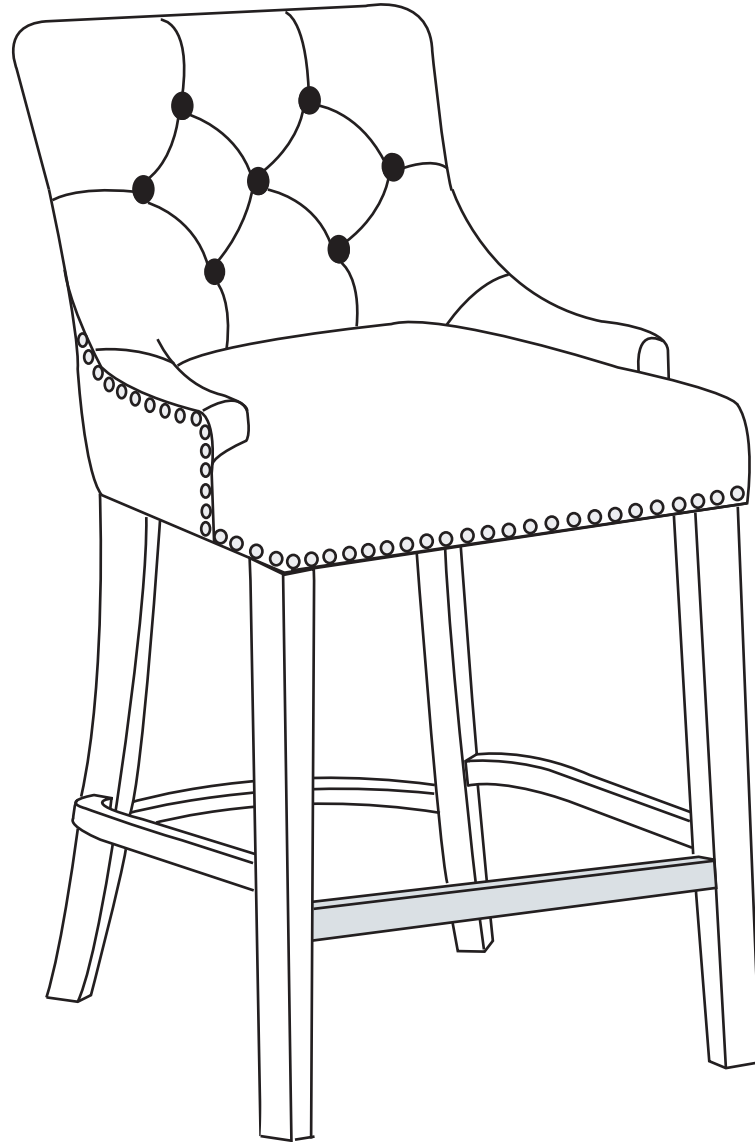

**24" Linen Fabric Tufted Upholstered Bar Stool**  
**SKU: ID404-24**

# ! CARE & MAINTENANCE

- Be careful when assembly, avoid hurting the paint .
- Clean the dust with lukewarm water, mild detergent & soft cloth.
- Firmly secure all bolts before use, do not use any part of this item as a step ladder.
- Reconfirm that all bolts, screws, and nuts are secure every 90 days.
- Do not use or store this item in the proximity of open flame or flammable/combustible chemicals.

## TOOLS REQUIRED



ALLEN WRENCH  
(PROVIDED)



SCREW DRIVER  
(NOT PROVIDED)



300 LBS  
CAPACITY



2 PERSONS  
ASSEMBLY



UP TO 20 MIN.  
ASSEMBLY

## HARDWARE

1

Flat washer



Φ8  
8PCS

2

Lock washer



Φ8  
8PCS

3

Allen Key



M8  
1PC

4

Shorter  
Screw



M8x55MM  
4PCS

5

Longer  
Screws



M8x65MM  
4PCS

6

Self-tapping  
Screws



M4x45MM  
8PCS

## PARTS

A

Back

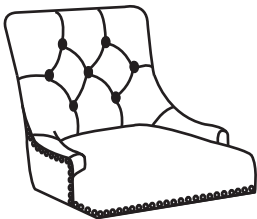

1PC

B

Front leg -Left

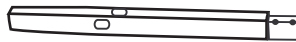

With Adjustable  
Feet Leveler

1PC

C

Front leg - Right

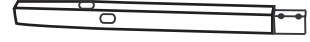

With Adjustable  
Feet Leveler

1PC

D

Hind Leg - Left

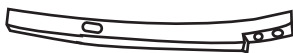

With Adjustable  
Feet Leveler

1PC

E

Hind Leg - Right



With Adjustable  
Feet Leveler

1PC

F

Side Footrest -Left



1PC

G

Side Footrest - Right



1PC

H

Front Footrest

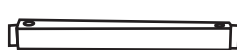

1PC

I

Hind Footrest



1PC

J

Front Metal Footrest



1PC

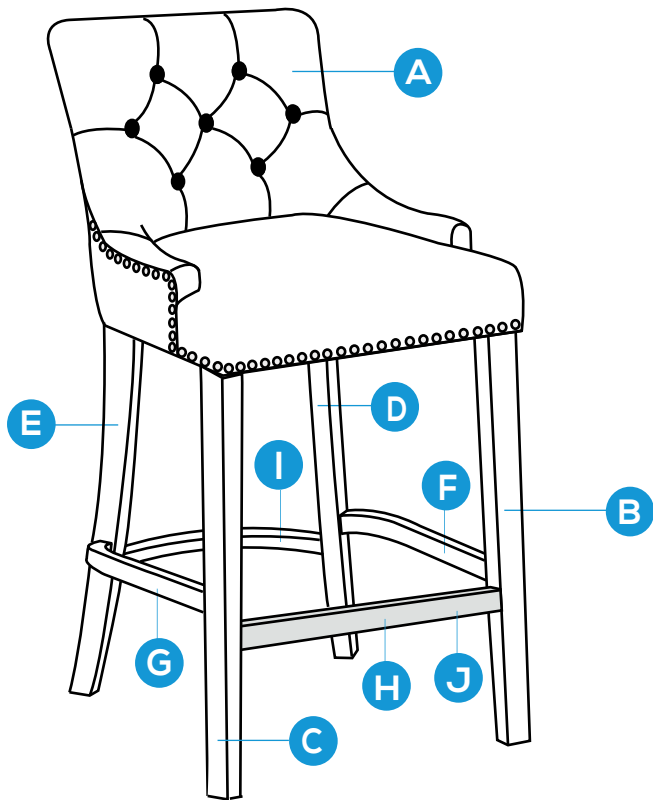

## PRODUCT ASSEMBLY

**1**

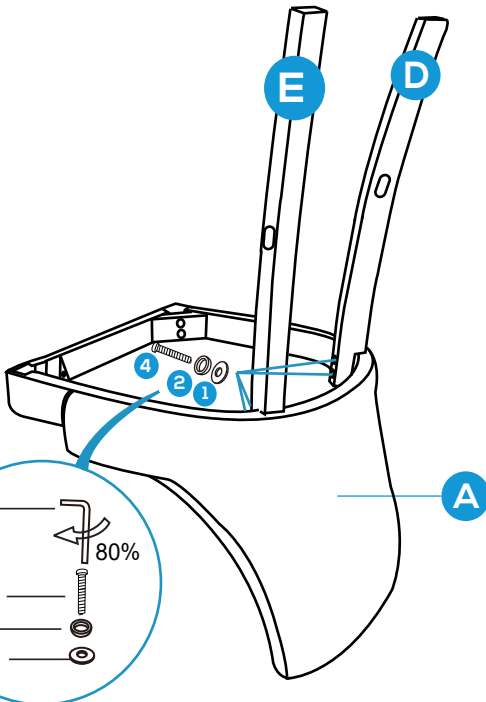

Put chair back on a clean flat surface.  
Align Hind legs in the seat pad as shown in the diagram.

Using SHORTER SCREW (4) with Washer (#2, 1).

**DO NOT FULLY TIGHTEN.**

First **HAND** tighten then tightened using key up-to 60-80% only at this stage.

## PRODUCT ASSEMBLY

2

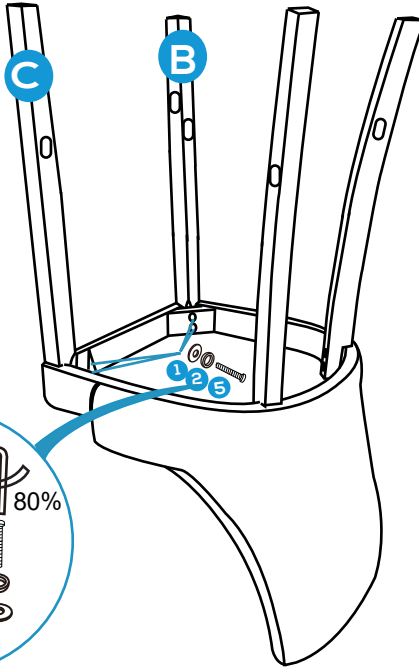

Align front legs in the seat pad as shown in the diagram.  
Using **LONGER SCREW (5)** with **Washer (#2, 1)**.

**DO NOT FULLY TIGHTEN.**  
First **HAND** tighten then tightened using key up-to **60-80%** only at this stage.

3

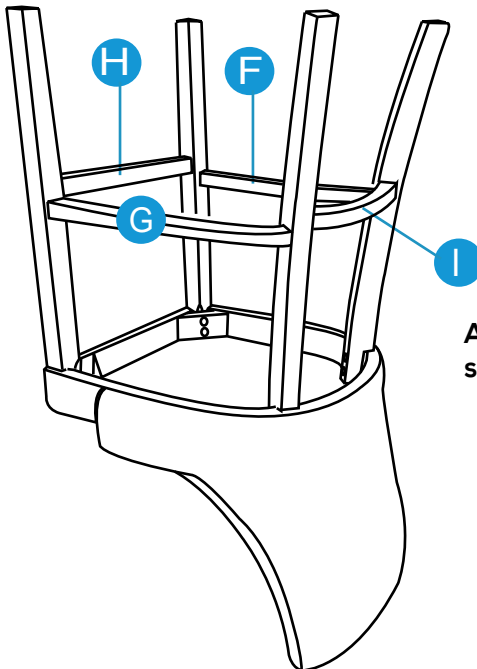

Align all footrest in the legs as shown in the diagram.

## PRODUCT ASSEMBLY

4

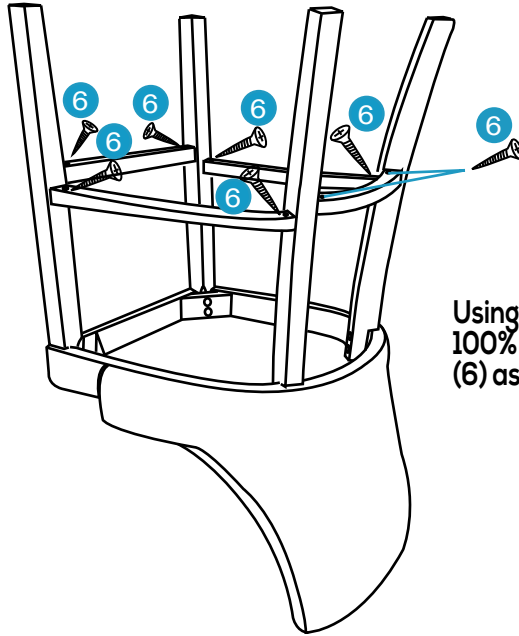

Using your own screwdriver  
100% lock Self-tapping Screw  
(6) as shown in the diagram

5

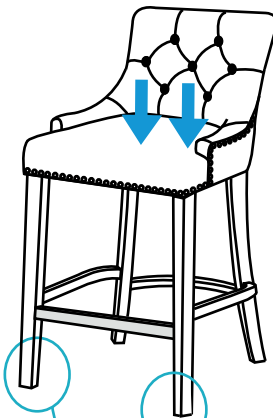
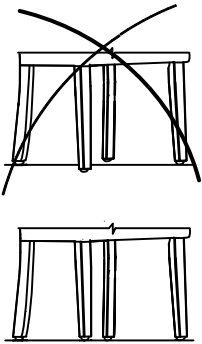

Put chair in the upright position and  
**SIT ON THE CHAIR** to press downwards on  
the seat pad.

Ensuring that all 4 feet touch the ground  
and chair is leveled.

Proceed to tighten all screws making sure  
the chair remains level when tightening.

Check that all screws are tight on a  
regular basis to ensure chair remains level  
and secure.

Also you can using adjustable feet to keep  
four legs level .

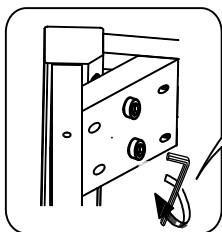

100%

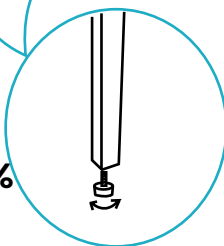

With Adjustable Feet Leveler

## PRODUCT ASSEMBLY

6

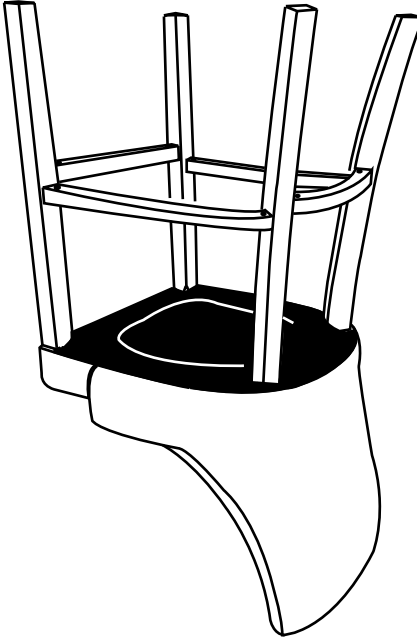

Then close the black fabric cover

7

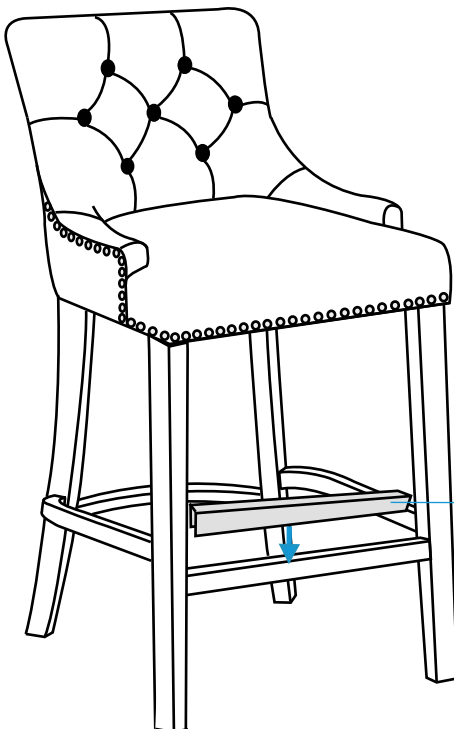

It is an option to add Parts J Front Metal Footrest on Parts H Front Footrest, to prevent from paint scratching when stepping on.

**GENTLY PUT IT ON AND DO NOT TAKE OFF FREQUENTLY IN CASE HURT THE PAINT.**

J