

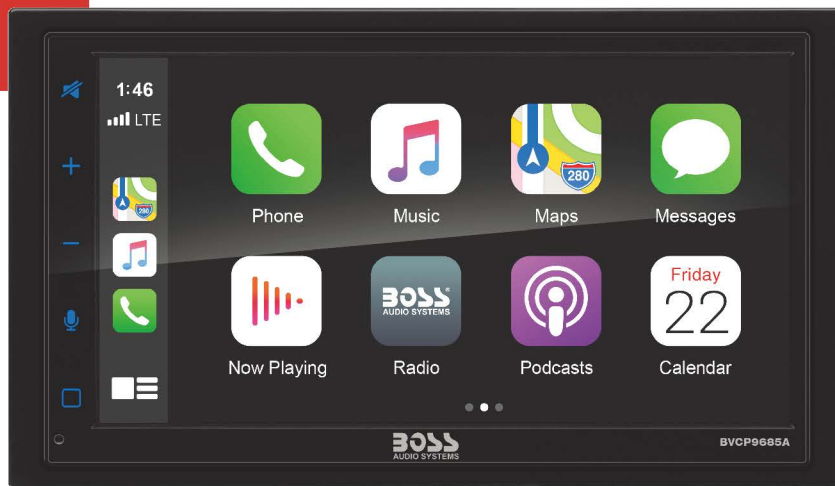

# BVCP9685A

## USER'S MANUAL

BLUETOOTH® | MP3-COMPATIBLE AM/FM RECEIVER  
FEATURING 6.75" (171 mm) CAPACITIVE TOUCHSCREEN





*Thank you for Choosing Boss Audio Systems!*

*IMPORTANT! Fill Out And Keep For Your Records.*



**IMPORTANT**

Record the serial number of the product:

**Model:**

**Serial Number:**

**Date of Purchase:**

The serial number is located on the top part of the chassis.

# Contents

<b>Contents</b> .....	<b>2</b>	CarPlay Display.....	16	Media Player Source Switching.....	20
Notes.....	4	Disable Apps.....	16	<b>Media</b> .....	<b>21</b>
<b>Cautions</b> .....	<b>5-7</b>	<b>Android Auto</b> .....	<b>17</b>	Warnings.....	21
About this Manual.....	7	Warnings.....	17	USB Playback.....	21
California Prop. 65.....	7	Using Android Auto.....	17	<b>Navigating Menu</b> .....	<b>21</b>
<b>Basic Product Operation</b> .....	<b>8</b>	<b>Bluetooth®</b> .....	<b>18</b>	Photos.....	21
What comes in the box.....	8	<b>Cautions</b> .....	18	<b>Radio</b> .....	<b>22</b>
Product Basics.....	9-14	<b>Setup &amp; Connections</b> .....	18	Display Overview.....	22
Using/Caring for the Touchscreen.....	12	Phonebook.....	18	Controls.....	22
Product Setup.....	13	Device Status.....	18	Tuning.....	22
<b>Navigating the Menus</b> .....	<b>14</b>	Calling.....	19	Bands.....	22
<b>Apple CarPlay</b> .....	<b>15</b>	History.....	19	Presets.....	22
Warnings.....	15	Private Mode.....	19	Favorites.....	22
Using CarPlay.....	15	Audio.....	20		
Gestures & Control.....	15	Track Control.....	20		

# Contents

<b>AV IN .....</b>	<b>23</b>	<b>Display Settings.....</b>	<b>26</b>	<b>Connections.....</b>	<b>28</b>
Playback.....	23	Illumination Control.....	26	Cautions & Warnings.....	28-33
<b>Camera.....</b>	<b>23</b>	Gamma.....	26	Power/SWC .....	28
Warnings.....	23	<b>Bluetooth® Settings.....</b>	<b>27</b>	Speaker.....	29
Reverse View.....	23	Device Name.....	27	Audio Pre-amp/AV IN/ Radio.....	30
<b>General Settings.....</b>	<b>24</b>	<b>Camera.....</b>	<b>27</b>	Camera/USB/MIC.....	31
Cautions.....	24	Rear Camera input.....	27	Parking Brake.....	32
System Language.....	24	Front Camera input.....	27	Hands-free Mic.....	33
Time Zone.....	24	Rear View pelay.....	27	<b>Troubleshooting.....</b>	<b>34</b>
Date & Time.....	24	<b>Radio Settings.....</b>	<b>27</b>	<b>Specifications.....</b>	<b>36</b>
Auto Adjust Daylight Saving.....	24	Region.....	27		
System Tone.....	24	RBDS.....	27		
Power Off Delay.....	24	Alternative Frequency (AF).....	27		
Parental Disc Lock.....	24	Traffic Announcement (TA).....	27		
<b>Audio.....</b>	<b>25</b>				
EQ.....	25				
Balance/Fader.....	25				
Subwoofer.....	25				
Loudness.....	25				
Internal Amp.....	25				
Volume.....	25				
Source level.....	25				

## Important

This symbol with “WARNING” is intended to alert the user to the presence of critical instructions/procedures. Failure to observe the instructions/procedures can result in injury, death, damage to the product and/or property.



This symbol with “CAUTION” is intended to alert the user to the presence of important instructions/procedures. Failure to observe the instructions/procedures can result in injury or damage to the product and/or property.



Use of the Apple CarPlay logo means that a vehicle user interface meets Apple performance standards.

**Apple is not responsible for the operation of this vehicle or its compliance with safety and regulatory standards. Please note that the use of this product with iPhone or iPod may affect wireless performance.**

iPhone is trademark of Apple Inc., registered in the U.S. and other countries.

Apple CarPlay is a trademark of Apple Inc.

The *Bluetooth*® word mark and logos are registered trademarks owned by Bluetooth SIG, Inc. and any use of such marks by Boss Audio Systems is under license. Other trademarks and trade names are those of their respective owners

## Caution

### Precautions

BE SURE TO OBSERVE THE FOLLOWING GUIDELINES: Do not turn up the volume so high that you can't hear what's around you.

Use caution or temporarily discontinue use in potentially hazardous situations.

Do not operate mobile video equipment while driving a motorized vehicle – **safe driving and safety consideration of others should** always be your highest priority.

Set your volume control at a low setting, then slowly increase the sound until you can hear it comfortably without distortion, or ear discomfort.

In the event you should notice smoke, strange noises or odor from this product, or any other abnormal signs, immediately turn off the power and consult your dealer or the nearest authorized **BOSS AUDIO SYSTEMS** Service Center.

Using this product in this condition may result in permanent damage to the system.

### Installation Precautions

Boss Audio Systems does not recommend to install the product yourself.

We recommend to have it professionally installed by a certified professional.

Always consult with a professional installer .

**Do not attempt to install or service this product by yourself.** Installation or servicing of this product by persons without professional training and experience in electronic equipment and motorized vehicle accessories may be dangerous and could expose you to the risk of electric shock, injury or other hazards

Refer any repairs to a qualified BOSS AUDIO SYSTEMS Service Center

## Caution

### Before Installing

To avoid potential shorts in the electrical system, be sure to disconnect the (-) battery cable before installation.

Use this unit with a 12-volt battery and negative grounding only. Failure to do so may result in a fire or malfunction.

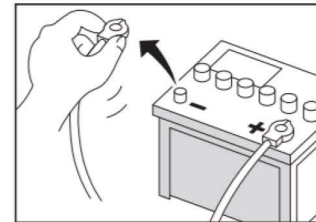

### Product Safety

It is against Federal and Local laws for video to be viewed by the driver while the vehicle is in motion. This video product was intended to be used with the parking brake safety feature. Video cannot be seen without the proper parking brake powered connection. Tampering or disabling this feature will void any and all warranty. Please check with a professional installer to have your product installed properly.



### Important Note

Due to ongoing enhancements, example images on screens may slightly differ from actual product.

## Caution

### Images and Video

Watching video while driving is against Federal, State, and Local laws.

**Drive safely, know and obey traffic rules. Watching this screen and making selections while driving can lead to a serious accident.**

Check surroundings for safety while camera images are displayed.

**Do not use features of this product while driving if it cannot be operated safely and legally in your location. Before operation of smartphone Apps accessible from this device, read safety instructions in your Owner's Manual. When using navigation Apps stay alert to observe real world conditions.**

### About this manual

To entirely understand how to properly use your new Boss product, it is recommended to read this entire user's manual, and keep it in a safe place for future reference.

-Read the entire manual

-Keep the manual

-Follow all instructions

-Clean with a dry cloth only

-Do not use or operate near water

-Do not defeat any safety features

### California Residents (Proposition 65)

This product may contain chemicals known to the State of California to cause cancer, birth defects or other reproductive harm.



# Basic Product Operation

## What comes in the box

### Hardware

- Qty 1 BVCP9685A
- Qty 1 Trim Ring
- Qty 1 **Mounting Hardware Set**
  - M5 x 6mm Bolts (8)
  - Brackets (2)

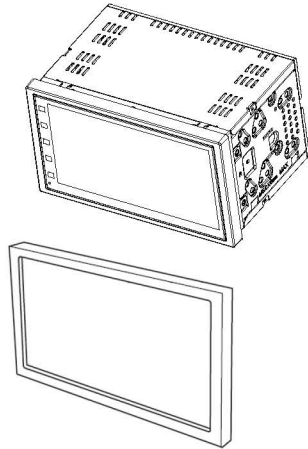

### Connections

- Qty 1 Power/Harness
- Qty 1 Hands-free Microphone

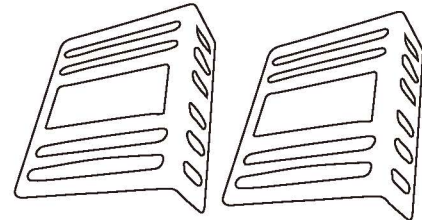
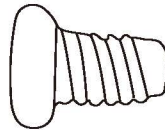
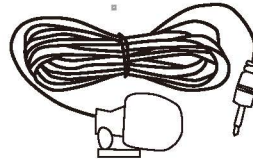

# Basic Product Operation

## Front Detail

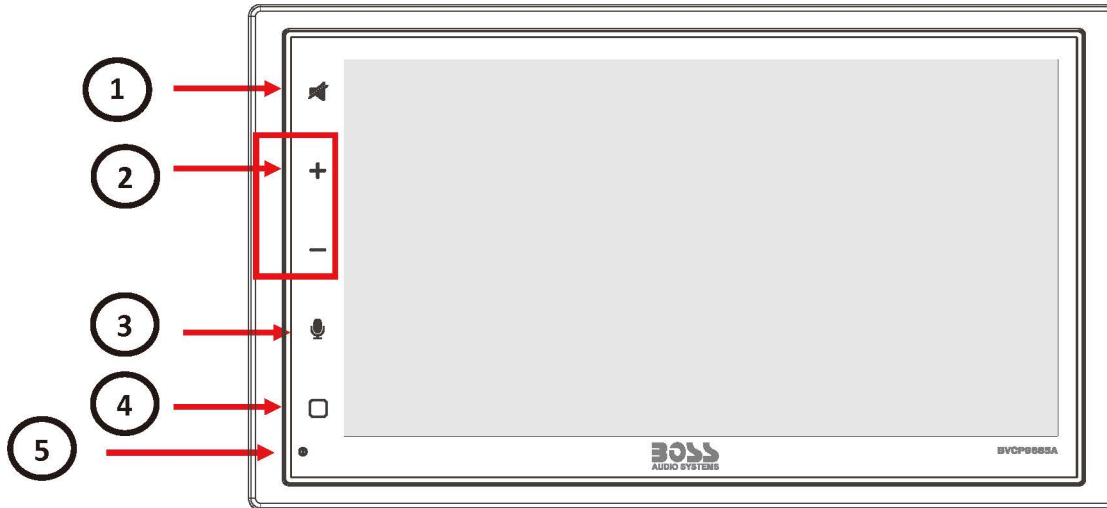

① Mute/Screen Off

② Volume Control

③ Siri Button

④ Power/Home

⑤ System Reset

# Basic Product Operation

## Rear Detail

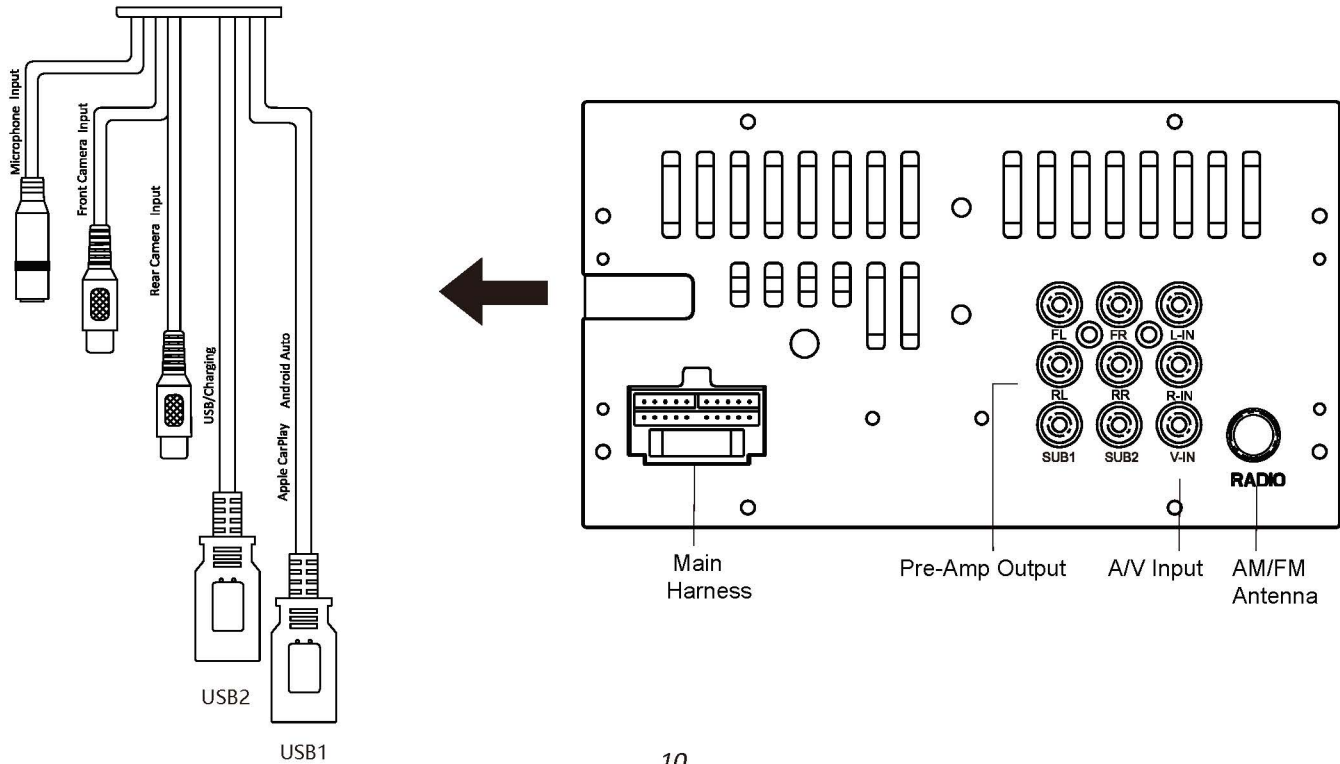

# Basic Product Operation

## Product Basics

### Mute

1. Touch to Mute

### Volume

1. Touch once on either "+" / "-"
2. Touch and Hold for quicker operation

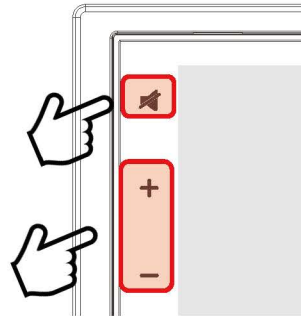

### Siri

- Touch to command

### **i** NOTE

CarPlay must be active

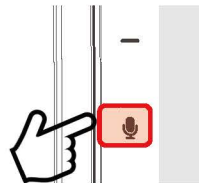

### Display Off

- Touch and Hold Mute

### Display On

- Touch the display to reactivate

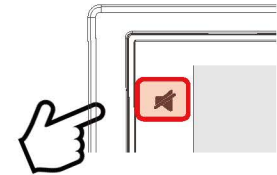

### Power On /Standby

1. Touch once to Power ON
2. Touch and Hold for Standby

### **i** NOTE

In Standby Mode, the LED will slowly pulse on and off.

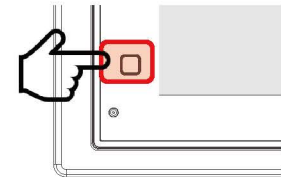

# Basic Product Operation

## Using and Caring for the Touchscreen



### Use:

This head unit utilizes a Capacitive Touchscreen, the same type that is used on high-end mobile devices. It should be used for and cared for like that type of device. As with all capacitive type technology, if your fingers are wet or sweaty, it will not function properly.

Do not allow any sharp objects to come in contact with the screen glass.

### Care and Cleaning:

To clean the screen, use a dry microfiber type cloth to clean. Do not use ammonia, window cleaner, or any other type of household chemicals to clean the screen. Abrasives should not be used at all.

# Basic Product Operation

## Product Setup (Date & Time)

### Setup Option A: CarPlay Method

Connect your Apple® device using a Lightning® cable\*. The CarPlay USB port must be used.

This will automatically setup the time and date.

User must set Time Zone manually.

Default is Pacific Time Zone

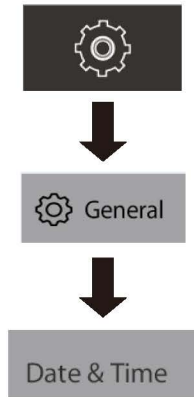

### Setup Option B: Date and Time

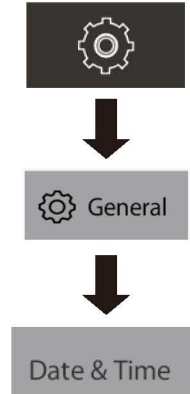

### Additional Setup

General > Language

Audio > EQ, Other Audio Settings

Display > Illumination, Brightness

# Basic Product Operation

## Navigating the Menus

### Android Auto

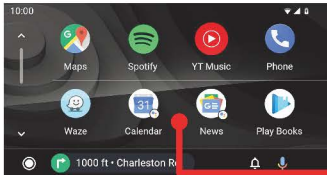

### Camera

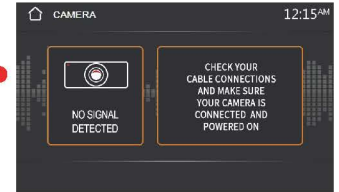

### CarPlay

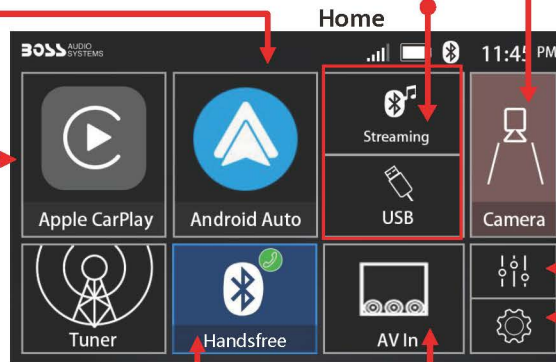
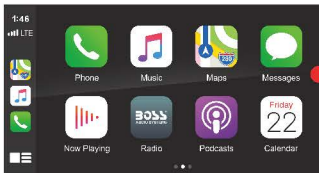

### EQ

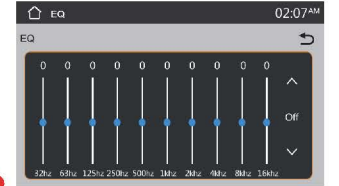

### Tuner



### Hands-free



### AV IN

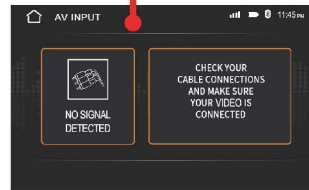

### Settings



# Apple CarPlay

## Using CarPlay

### Note

Apple CarPlay usage is limited while driving.

**Functions, contents, and usability** is determined by the App provider(s).

Controls will vary with each App that is available for CarPlay.

For more details visit:

<http://www.apple.com/ios/carplay>

### WARNING

Familiarize yourself with your Local and State laws regarding mobile devices.

**Certain functions of an iPhone might be prohibited and or illegal while driving in your location.**

When in doubt, park the vehicle and engage the parking brake first before performing the function(s).

### Connecting to CarPlay USB Port

1. **Connect the CarPlay compatible device** via LIGHTNING<sup>®</sup> cable (not included).
2. The iPhone will load the CarPlay **function.**
3. On the display, the CarPlay will illuminate green, touch it to enter the CarPlay menu.
4. To return to the product Home menu,

Touch



### NOTE

The product's Bluetooth will turn **OFF automatically when CarPlay is in use.** Hands-free phoning will function through the CarPlay feature.

When using CarPlay, there is no need to pair your iPhone, the USB cable connected through the USB Port (1) will enable this feature.

If other devices are connected via Bluetooth, **they will be disconnected for the duration of CarPlay use.**

### Gestures & Control

Basic controls, but not limited to:

Touch



Swipe



Dragging



Other gestures and controls might differ on each App.

### NOTE

Volume control is handled exclusively by the product.



# Apple CarPlay

## Using CarPlay

### CarPlay Display Setup

1. Using your iPhone:

**Settings > General > CarPlay**

2. **Touch and Hold** each App icon to move.

To remove an App, **Touch** 

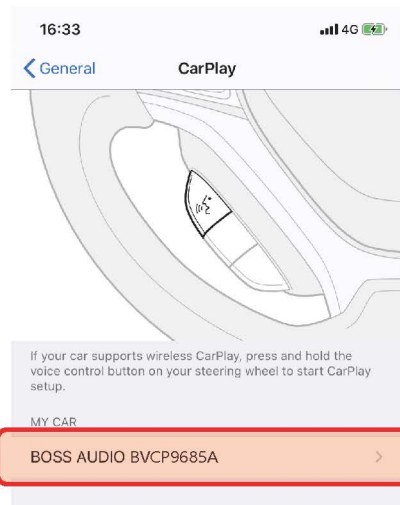

### NOTE

Only Apps with the  icon can be removed from CarPlay.

Only Apps with the  icon can be added in carplay.

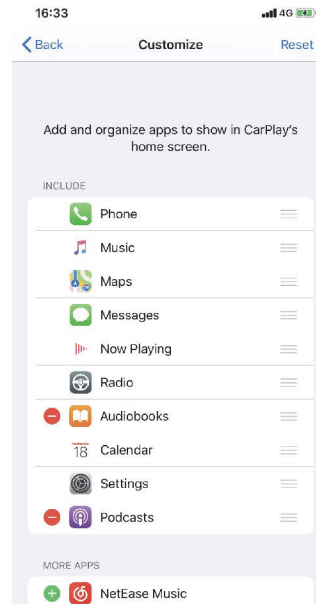

### How to Disable Apps

1. Using your iPhone:

**Settings > Notifications > App to Disable**

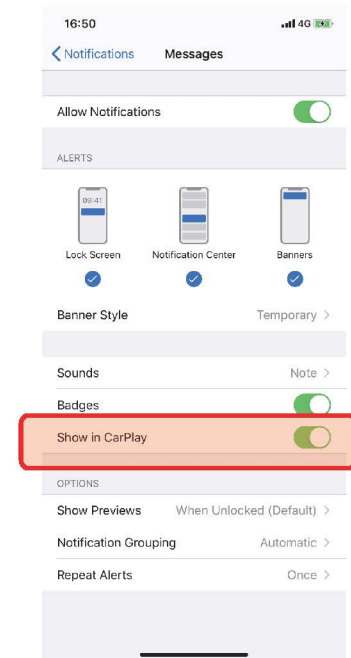

# Android Auto

## Using Android Auto

### Note

Android Auto usage is limited while driving.

**Functions, contents, and usability** is determined by the App provider(s).

Controls will vary with each App that is available for Android Auto.

For more details visit:

<https://www.android.com/auto/>

### WARNING

Familiarize yourself with your Local and State laws regarding mobile devices.

**Certain functions of the mobile device might be prohibited and or illegal while driving in your location.**

When in doubt, park the vehicle and engage the parking brake first before performing the function(s).

### NOTE

To complete the setup properly, the Parking Brake status wire must be connected.

### WARNING

For your safety, the setup process **MUST** be accomplished while the vehicle is **Parked and Parking Brake Engaged**.

### Android Auto App

1. Using your Android device, download the **Android Auto** app on Google Play.



Minimum Requirements:

**Android 5.0 Lollipop**

For a list of compatible devices:

<https://www.android.com/auto/>

### Updating Related Apps

1. During the first start up and setup of the Android Auto app, the Maps, Music, Google apps will install/update automatically.

### Connecting to Android Auto USB Port

1. **Connect the Android compatible device** via the appropriate USB cable (not included).
2. The Android device will load the **Android Auto function**.
3. **Bluetooth will connect automatically** when the setup is completed.

### Android Auto Permissions Permissions

Several features can be allowed or denied access to customize your usability of the product.

**The access can always be modified in Settings on the Android device.**

# Bluetooth®

## Setup & Connection

### Hands-Free Menu



#### NOTE

**CarPlay must not be active. If being used, disconnect the iPhone to start Bluetooth.**

Compatibility with all mobile devices is not guaranteed. Please read through the user's guide of the mobile device.

#### CAUTION

For your safety, the setup process should be accomplished while the vehicle is parked and parking brake engaged.

### First time Pairing

Using your phone, media or other Bluetooth device, try to connect to this headunit.

Mobile Device:

Search for **BOSS AUDIO BVCP9685A**

iOS Devices: **Settings > Bluetooth**

Android Devices: **Settings > Connections > Bluetooth**

A passcode is generated and will display on both the head unit and mobile device for secure pairing.

Touch  to confirm

The image shows a green circular button with the word "YES" in white capital letters.

Every time the product is powered ON, the mobile device will automatically connect if within range.

#### NOTE

Once paired and connected, the device list will display the available Bluetooth profiles.



### Phonebook and History

To **Download Phonebook**:

1. Touch **Contact > Download**

To **Download History**

1. Touch **History > Download**

### Device Status

**Battery and Cellular Strength** is displayed on the top right of the Home menu.

GATT Profile support is required on the mobile device.



# Bluetooth®

## Hands-Free

### Calling

#### Making & Receiving Calls

1. Dialing from the dial pad

Touch  to make call

2. Contacts

Touch the contact name

3. History

Choose the name, then

To End a call Touch 

To Mute a call Touch 

#### Dial pad

To use the dial pad while on a call

Touch 

#### Searching History

Swipe Up or Down to search



### History

1. Outgoing Call 

2. Incoming Call 

3. Missed Call 

### Private Mode

When a call needs to be transferred to the mobile device:

Touch  to switch the mobile device

Touch  to return to hands-free mode

### Searching Contacts

Contacts must be downloaded to search.

1. Touch 

2. Enter the Contact Name, then

Connection: ON

Auto Connect: ON

Auto Answer: OFF

Device Name: BOSS AUDIO BVCP9685A

Clear Records

# Bluetooth®

## Audio

### Audio Streaming

To play media through Bluetooth, the mobile device must be **Paired and Connected** to the BVCP9685A



The music will play automatically.

### Track Control

1. Play/Pause 
2. Track Fwd / Rev 
3. **Swipe** to Fwd/Rev 

### Note

For best performance, your mobile device **volume setting should be set to maximum.**

All volume adjustments for the system should be controlled from the product.

**The unit will recall the last volume setting on your mobile device every time it connects.**

### Formats

Playback is supported from the mobile device with any format it can play.

Audio will only be played by the product.

Video cannot be viewed on the unit.

### Switching Media



Available sources will display **(Bluetooth and USB)**

### Note

USB source will only be displayed if a USB drive is inserted and has playable media.

### Display

Track info will be displayed when available.

**Track, Album and Artist.**

Album art is not supported via Bluetooth playback.

# Media

## USB

### USB/SD Playback



The music will play automatically.





### Audio Control

1. Play/Pause 
2. Track Fwd / Rev 
3. Repeat ALL 
4. Repeat One 
5. Random 





### Note

If there are other files in the USB, music files will play first.

### Video Control

1. Play/Pause 
2. Track Forward/Backward 
3. Repeat All 
4. Repeat one 
5. SETUP 

### Photo Control

1. Play/Pause 
2. Track Forward/Backward 
3. Repeat All 
4. Repeat One 
5. Rotate 

### Navigating Menu



To browse contents **Swipe** 

To return to the current file playing,

Touch 

### **WARNING**

Watching videos or photos while driving is against Federal, State, and Local laws.

Do not use features of this product if it cannot be operated safely and legally in your location.

### **Note**

Review the connections of this product, to properly integrate the parking brake wire to the vehicle.

Video and or photos cannot be viewed while driving. The vehicle must be stationary and the parking brake applied to enable viewing.

# Radio

## AM/ FM

### Controls





### Tuning

To search for stations:

Search

Touch and Hold  

Manual Seek

Touch  

Auto Search & Store: Touch 

### Note

RBDS info (if available) and currently tuned station will display on the radio icon in the home screen

Not all stations will have or display RBDS info.

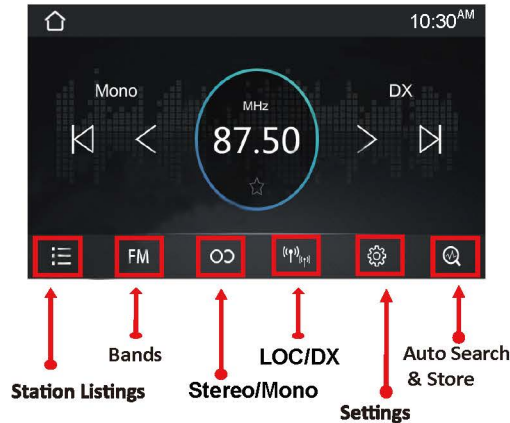

### Band & Settings

Touch FM to switch bands

To change radio settings

Touch 

### Favorites and Presets

Settings Favorites

Touch  Favorite Set 

To remove a favorite, Touch  **Browsing Favorites**



To return the Tuner screen Touch

### Changing Presets

Touch  

To list all Stored Stations

Touch 

### Stereo/Mono

To turn on/off stereo when receiving a stereo signal ,

Touch 

### LOC/DX

To select Local or Distant broadcasting stations,

Touch 

# AV In/Camera

## External Source

### Playback

Touch



Media must be controlled from the external device.

Track functions are not controlled from the product.

### **i** Note

To adjust the volume level properly, the carry-in device volume should be set between 50 % - 75%. The volume level should remain at that level for the remainder of the time it is connected to the product.

### **!** WARNING

Never rely solely on the rear view camera; always check your surroundings before proceeding.

### Images may appear reversed

Do not use features of this product if it cannot be operated safely and legally in your location.

### Rear View

The rear view camera can be displayed on demand.

Touch



If the user opens the SETTINGS interface and turn on both FRONT CAMERA and REAR CAMERA functions, you can choose REAR CAMERA and FRONT CAMERA casually.



To return to the Home screen

Touch



### Reverse View

When the vehicle is put into reverse gear, the camera will display the image on the screen.

CHECK SURROUNDINGS BEFORE PROCEEDING



### Rear View Delay

Due to varying vehicle configurations, the rear view trigger can be delayed to best suit the vehicle.

Default setting: 0 Sec Delay

### **i** Note

The rear view camera will still function normally, if the product is in standby mode



# Settings

## General

### System Language

Touch to change

English (Default), Spanish

#### Note

CarPlay is independent of the system language setting.

### Time Zone

Adjust to correctly display time

Default Setting: (GMT-08:00) Pacific Time  
(US&Canada)

### Date & Time

24H Mode



### Auto Adjust Daylight Saving



#### Note

If using an CarPlay, the iPhone will automatically set date & time. Time Zone needs to be adjusted manually.

### System Tone



### Power Off Delay

Some vehicles during crank to start will interrupt the accessory power.

If the product re-boots during crank to start, Turn ON delay

The delay can select 1, 2 or 3 sec.

Default Setting: OFF

#### Note

Power Off Delay ON will also delay when the vehicle is turned OFF.

This might affect hands-free functionality during a call.

### Parental Disc Lock

Touch to select parent control level.

### Factory Settings

To restore settings to default:

Touch 



Will restore all settings to factory defaults.  
All settings and presets will be lost.

# Setting

## Audio

### EQ

To access the EQ menu

Touch

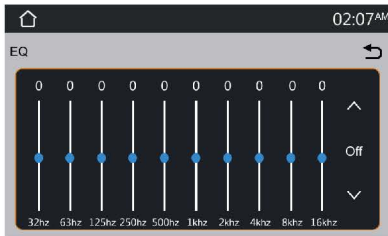

### Note

The EQ can also be directly accessed while changing the volume. The volume display will show the EQ icon, you can touch to access the Audio Settings.



### Preset EQ

Jazz, HipHop, Pop,Rock, R&B

### Balance/Fader

Left/Right Balance, Touch



Swipe for quick adjustment



Front/Rear Fader, Touch



Swipe for quick adjustment



### Subwoofer

The level and filter can be adjusted for the Sub pre-amp output.

Level, 1-14 dB

Swipe

Filter: 50Hz, 80 Hz, 120 Hz, 160 Hz

Touch +/- Subwoofer Frequency

### Loudness

Enhances and gently boosts low and high freq.

Touch OFF → ON

### Internal Amp

To reduce the possibility of noise entering the signal chain when utilizing the audio pre-amp outputs, the internal amp can be turned OFF

Touch ON → OFF

### Volume

Settings are for default volumes for Main(Radio, Media), Hands-free(BT Ring, BT Talking), Apple CarPlay/Android Auto (Navi, Voice).

### Source Level

The source mode(Radio, USB, BT Audio, AV Input, Apple carplay, Android Auto) gain control.

# Settings

## Display

## Bluetooth

### Illumination Control



When the vehicle lights are on, the products illumination can be customized for night use.

### Gamma



Gamma can be adjusted for both day and night settings.

### Screen Brightness



### UI settings

#### Wall paper

Touch to change

User can change the background picture by inserting a USB with photos.

#### Background Brightness



### Connection



Power On/Off Bluetooth

Default Setting: ON

### Note

Bluetooth will turn OFF automatically when CarPlay is in use. If other devices are connected via Bluetooth, they will be disconnected for the duration of CarPlay use.

### Auto Connect



Auto connects to the device when the product is powered ON

Default Setting: ON

### Auto Answer



Auto answers when there is an incoming call.

Default Setting: OFF

# Settings

## Bluetooth

### Device Name

BOSS AUDIO BVCP9685A

### Rear Camera input

Turn on if you have a rear view camera, turn off if you have not.

### Front Camera Input

Turn on if you have a front view camera, turn off if you have not.

### Parking Assist guide

Turn off if your rear view camera have parking assist guide, turn on if you have not.

### Parking Assist guide Adjust

You can adjust parking assist guide

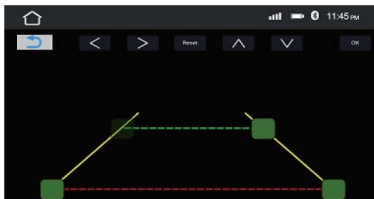

## Camera

### Rear View Delay

0 Sec (Default), 0.1 Sec, 0.5 Sec, 1 Sec, 2 Sec  
When switching from Park to Drive, or vice versa, the camera should not trigger on the display.

Sensitivity should be adjusted to trigger only on reverse gear selector.

### Region

Touch 

Default Setting: USA 2

US Tuner Spacing: FM (200 KHz), AM (10 KHz)

European Spacing: FM (50 KHz), AM (9 KHz)

### RBDS, Radio Broadcast Data System

Touch 

Default Setting: ON

Allows data from the radio station to be displayed on the product.

## Radio

### RBDS, Cont'd

Not all stations will broadcast information to display.

### AF (Alternative Frequency)

Touch 

When On, the tuner will automatically locate the same tuning program on other stations and select the strongest signal of those being broadcast.

Default Setting: OFF

### TA (Traffic Announcement)

Touch 

The radio will automatically tune in to traffic information broadcasts while receiving FM broadcasts playing media.

Default Setting: OFF

# Connections

## Power/SWC

### ⚠ CAUTION

It is recommended to have the product installed by a certified installation professional.

### ⚠ CAUTION

Before installation, or wiring connections, disconnect the negative (-) battery terminal to prevent damage to the product, and/or possible injury.

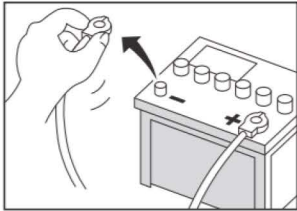

### ⚠ CAUTION

Remote Out is 500 mA max output rating. If several amplifiers are to be used, it is recommended to use a relay for the Remote Out trigger.

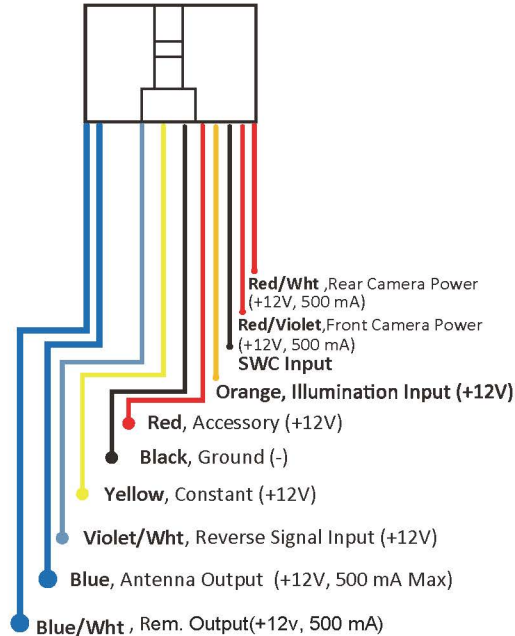

### i Note

Unused input/output wires need be insulated with tape, heat shrink, or crimp connectors. **Never use wire nuts.**

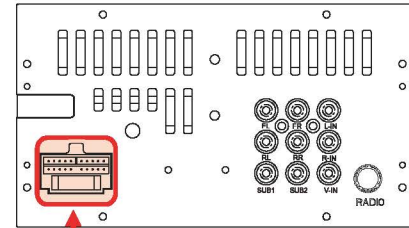

Location to plug in

### i Note

A separate interface might be needed for your vehicle application. It is recommend that you consult with a professional installer.

### i Note

When replacing the fuse, always do so with the same type and value (15 A).

# Connections

## Speakers

### ⚠ CAUTION

Do not chassis ground any speaker wire leads.

### ⚠ CAUTION

Only use 4-8  $\Omega$  Speakers

Do not use 1-3  $\Omega$  Speakers

### ⚠ CAUTION

Do not bridge any of the channels, they are only to be wired in stereo mode.

### i Note

Unused speaker wires need be insulated with tape, heat shrink, or crimp connectors.

**Never use wire nuts.**

If the speaker outputs are not used, turn **Off** the internal amp to reduce the possibility of noise entering the signal chain.

### i Note

Observe speaker polarity when making connections.

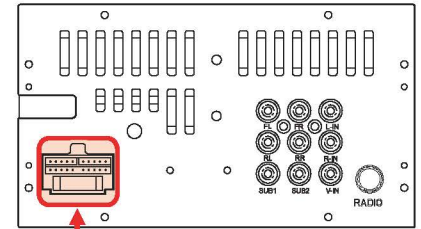
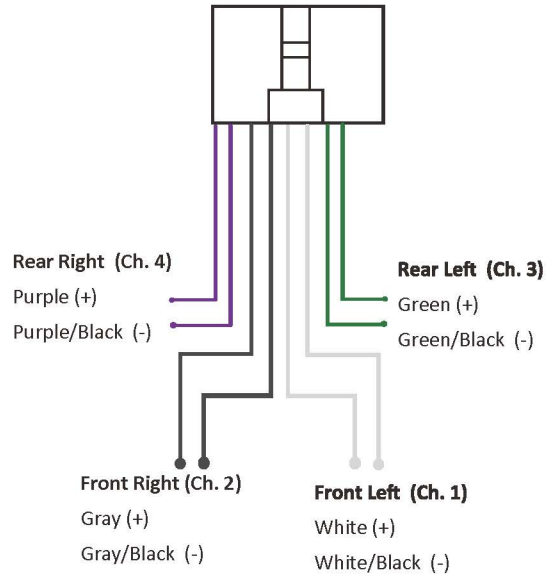

Location to plug in

# Connections

## Audio Pre-amp/AV IN/ Radio

### **i** Note

Subwoofer Pre-amp is a non-fading mono output.

### **i** Note

Always run signal wires away from power cables to reduce the possibility of noise.

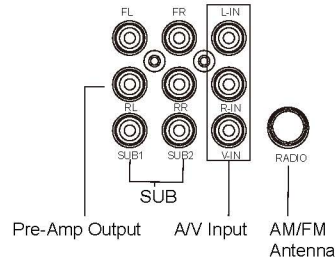

### **i** Note

If pre-amp outputs are being used exclusively, turn **Off** the internal amp of the product, to reduce the possibility of noise entering the signal chain.

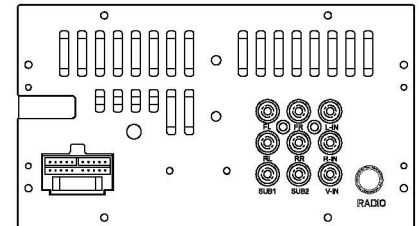

**Location to plug in**

# Connections

## Camera/USB/MIC

### **WARNING**

Never rely solely on the rear view camera; always check your surroundings before proceeding.

### **Images may appear reversed**

Do not use a feature of this product if it cannot be operated safely and legally in your location.

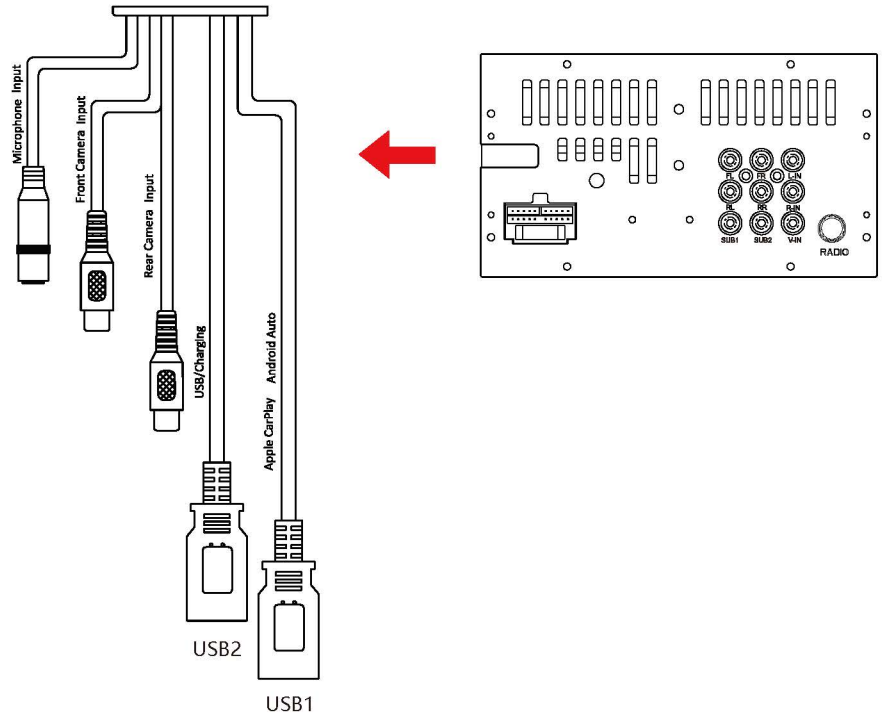



# Connections

## Parking Brake

### **WARNING**

Improper connection or use of the parking brake status wire, (i.e. defeating the safety feature) violates Federal, State, and Local laws. This may lead to injury, property damage, and/or death.

### **WARNING**

Watching videos or photos while driving is against Federal, State, and Local laws.

### **Note**

For Android Auto setup, the parking brake status wire **MUST** be connected.

### **Note**

#### **Note**

Review the connections of this product, to properly integrate the parking brake wire to the vehicle.

Video and or photos cannot be viewed while driving. **The vehicle must be stationary and the parking brake applied** to enable viewing.

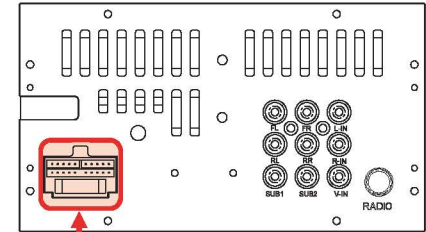
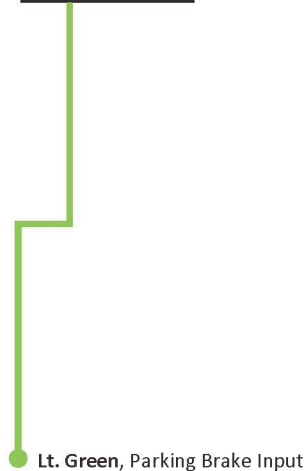
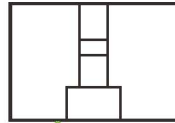

 **Power/Speaker/SWC/MIC  
Harness**

### **Note**

The parking brake input needs to be connected to the power side of the parking brake.

### **Note**

Every vehicle has a different type of parking brake connection; consult a certified professional installer.

# Connections

## Hands-free Mic

### Placement

Every vehicle will perform differently due to layout, interior materials, etc...

The **Red** shaded areas are the recommended locations for best microphone performance.

Items to look for before placement:

1. Do not place in front of air vents.
2. If the vehicle has tweeters placed on sail panels, do **NOT** locate the mic on steering column area.
3. Front of mic must not be blocked.
4. **Mic should be firmly attached to mounting location.**
5. Do not cover the grille openings surrounding the mic.
6. To avoid excessive wind noise, do not place near the sunroof opening

### **WARNING**

Run microphone wire where it will **NOT** impede the operation of any safety items, i.e. Airbags, Knee Airbags, etc...

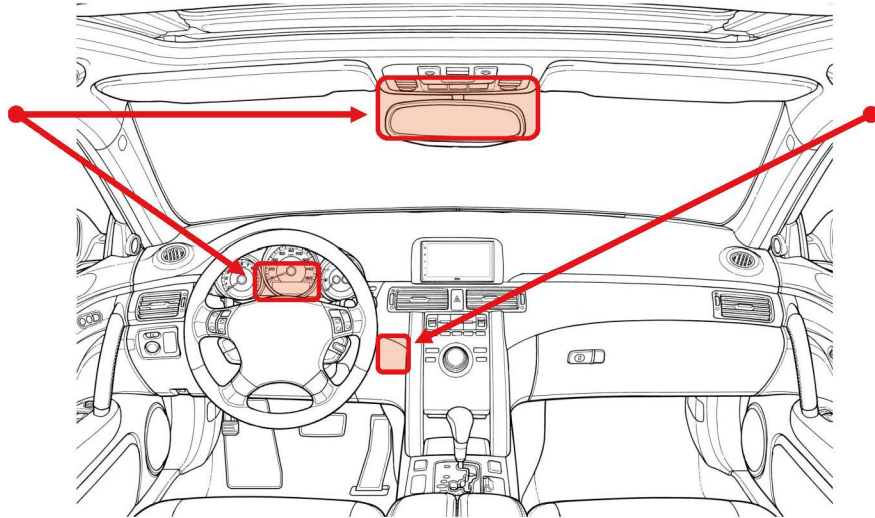

# Troubleshooting

Issues	Cause	Solution
No Sound	Internal amplifier is off Product is muted External amplifiers  Audio source	<b>Go to Settings &gt; Audio &gt; Internal Amp ON</b> Touch the volume. Check the external amplifiers are on. Check the remote output wire has voltage Change the audio source
Media Not Supported	Media on USB flash drive	Change the media format on the USB device Change the USB device
Bad Radio Reception	Radio area  Antenna	<b>Change the station</b> Turn OFF AF and TA Turn OFF RBDS Antenna output wire isn't connected Connect Antenna to product
Apple CarPlay/Android Auto will not start	Bad Lightning®/USB cable Locked device Not charged  CarPlay/Android Auto frozen	Replace the cable Device needs to be unlocked Device needs to be powered ON for CarPlay/ <b>Android Auto to function. Allow it to charge and power on.</b> Unplug the device, close all Apps and plug it in again.
Bluetooth	<b>Not connecting to device</b>	Make sure the device is within range. <b>Devices' Bluetooth connection needs to be turned ON</b>

## Troubleshooting

Issues	Cause	Solution
Bluetooth	Not connecting to device	Go to <b>Setting &gt;Connection &gt;Power ON</b> Pair and Connect the device like new.
Hands-free call quality	Mobile device Microphone	Check cellular strength on mobile device. End call and redial number. Microphone placement needs to be relocated. <b>Microphone needs to be firmly attached to location it's mounted on.</b> Check to see if microphone is properly plugged in.
Unit is unresponsive	Processor has frozen	Press the <b>RESET button on the front panel</b>



If you have questions about this product:

Customer Service

**805-751-4853**

M-F 8:30a-5:00p (PST)

*Tech Support: [www.bossaudio.com/support/technical-support](http://www.bossaudio.com/support/technical-support)*

*© 2019 Boss Audio Systems*

# Specifications

## General

Power Input.....	8.5 V—18 V DC
Nominal.....	14.4 V DC
<b>Current Consumption.....</b>	<b>15A</b>
Fuse Type.....	15A
Dimensions (H x W x D).....	3.9" x 7" x 5"
Head Unit Weight.....	2.34 lbs.
<b>Operational Temperature.....</b>	<b>-4—158°F</b>

## Display

Screen Size.....	6.75"
<b>Aspect Ratio.....</b>	<b>16 x 9</b>
<b>Resolution.....</b>	<b>1024 x 600</b>
Screen Type.....	TFT-LED Active Matrix

## Audio

Max Power.....	80 W x 4 Ch.
Acceptable Speaker Load.....	4-8 $\Omega$
Preset EQ.....	5
EQ Bands, Adjustable.....	10
JAZZ, HIPHOP, POP, ROCK, R&B	
32, 63, 125, 250Hz, 500Hz	
1KHz, 2KHz, 4KHz, 8KHz, 16KHz	
EQ Boost/Cut.....	$\pm$ 6 dB

## Audio Cont'd

Pre-amp Output.....	3 Pairs
Front.....	4V, Full-Range
Rear.....	4V, Full-Range
Sub (Mono).....	4V, LPF
Sub LPF.....	50 Hz, 80 Hz, 120 Hz, 160 Hz
Sub Level.....	+1-14dB

## Radio Tuner

Freq. Range.....	87.5 MHz-108 MHz (FM)
Freq. Range.....	522 kHz-1710 kHz (AM)
USA 1 Range (FM).....	100 kHz Spacing
USA 2 Range (FM).....	200 kHz Spacing
Europe Range (FM).....	50 kHz Spacing
RBDS.....	AF, TA

## Apple CarPlay

iPhone Support.....	iPhone 5 or Newer
iOS.....	iOS 7.1 or Newer

## Android Auto

Supported.....	(5.0) Lollipop or Newer
----------------	-------------------------

## USB

USB Spec.....	USB 2.0 (High-Speed)
USB Port 1: Carplay & Android Auto.....	
Current Output	1.5A
USB Port 2: Media & 1.5A Charging .....	
Current Output	1.5A
File System.....	FAT32
Audio Playback.....	WAV, MP3
Video Playback.....	AVI, MKV, WMV
Picture Playback.....	JPG, PNG, BMP

\*Not all listed compressed files guaranteed to play due to different creation methods or file contents.

## Bluetooth®

Version.....	v4.2+E.D.R.
Audio Codec.....	S.B.C.
Profiles.....	
HFP v1.6,A2DP v1.2,AVRCP v1.5,PBAP v1.1	

## User's Notes



**BOSS Audio Systems**  
3451 Lunar Court - Oxnard, CA 93030  
**[www.bossaudio.com](http://www.bossaudio.com)**  
**805-751-4853 Customer Service**  
**Tech Support: [www.bossaudio.com/support](http://www.bossaudio.com/support)**



**0920**

iPhone® is a trademark of Apple Inc, registered in the U.S. and other countries. Apple CarPlay is a trademark of Apple Inc. BOSS Audio Systems is not affiliated with Apple Inc.

The Bluetooth® word mark and logos are registered trademarks owned by Bluetooth SIG, Inc. and any use of such marks by BOSS Audio Systems is under license.

Other trademarks and trade names are those of their respective owners.

Use of the Apple CarPlay logo means that a vehicle user interface meets Apple performance standards. Apple is not responsible for the operation of this vehicle or its compliance with safety and regulatory standards.

Please note that the use of this product with iPhone may affect wireless performance.

# 此页只是文件说明, 不做印刷用!

文件名  
File Name 20CHZ224-IM-V1.1

版次  
Revision V1.1

机型  
Project# CVD6472-SD

比例  
Scale 1:1

客户/品牌  
Customer BOSS AUDIO

公差  
Tolerance ±3mm

尺寸+P数  
Size 英文版,210\*145mm,共44P

设计  
Designer 陈慧虹

材质  
Material 封面(彩色印刷+1专 PANTONE485+亮膜)  
工艺  
technique 200G铜版纸,内页80G铜版纸,  
彩色印刷+1专 PANTONE485,打钉

审核  
Checked 吴国琼

设计日期  
Design Date 2020.9.11

注释:  
Remarks:

描述  
Description

封面背面为空白页