

Redington™ WASHLET®+ S7A One-Piece Toilet - 1.0 GPF

FEATURES

- Concealed supply connection for seamless installation
- Ultra high-efficiency TORNADO FLUSH® system - 1.0 GPF (3.8 LPF)
- CEFIONTECT® ceramic glaze prevents debris and mold from sticking to ceramic surfaces
- Completely skirted design for a sleek and understated look that's easier to clean
- Universal Height
- Chrome plated trip lever
- 12" Rough-in
- Elongated front bowl and WASHLET+ S7A set
- Touchless auto open/close lid
- EWATER+® auto-cleans wand and bowl after every use
- PREMIST® automatically mists the bowl before each use
- Self-cleaning wand cleans itself inside and out before and after every use
- CLEAN RESIN® keeps wand and seat cleaner, more hygienic, and effortless to maintain
- Multifunction pearl white remote control with personalized memory settings for up to 4 users
- Night light illuminates the side and the inside of the bowl
- Auto flush available as upgrade

MODELS

- **MW6724736CUFGA (#01)**
With CEFIONTECT ceramic glaze, WASHLET+ S7A with contemporary design and Auto Flush
 - **CST672CUFGAT40**
Elongated bowl with CEFIONTECT
 - **SW4736AT40**
WASHLET+ S7A
 - **THU856**
Auto Flush Kit
- **MW6724736CUFG (#01)**
Same as MW6724736CUFGA without Auto Flush







OPTIONAL COMPONENTS

- **TSU10W.10**
10" Unifit Rough-in
- **TSU10W.14**
14" Unifit Rough-in
- **THU887(#01, #BN, #MBL, #PN)-A**
Left Hand Trip Lever Handle (Cotton, Brushed Nickel, Matte Black, Polished Nickel)

COLORS/FINISHES

- #01 Cotton



-  **TORNADO FLUSH**
-  **UNIVERSAL HEIGHT**
-  **CEFIONTECT**
-  **EWATER+**
-  **AUTO FLUSH**
-  **SKIRTED DESIGN**
-  **1G 1 GALLON PER FLUSH**

PRODUCT SPECIFICATION

The one-piece ultra high-efficiency TORNADO FLUSH system toilet shall be 1.0 GPF. Toilet shall be 12" Unifit rough-in. Toilet shall have optional CEFIONTECT ceramic glaze and be at Universal Height. Toilet shall have elongated front bowl with SoftClose seat and Polished Chrome trip lever. Toilet shall be TOTO Model MW6724736CUFG__#01.

See SW4736AT40 Specification Sheet for details on included WASHLET.

CODES/STANDARDS

- Meets and exceeds ASME A112.19.2/CSA B45.1
- Certifications: IAPMO(cUPC®), EPA WaterSense, State of Massachusetts, and others
- Code Compliance: UPC, IPC, NSPC, NPC Canada, and others
- Legislative Compliance: California AB715, California Green Building Code, City of Los Angeles Water Efficiency Ordinance, and others
- ADA compliant for residential use with autoflush feature model, or with trip lever located on the approach side
- Complies with CA Prop 65 warning requirements



MW6724736CUFG(A)

Redington™ WASHLET®+ S7A One-Piece Toilet - 1.0 GPF

SPECIFICATIONS

Water Use	1.0 GPF (4.8 LPF)
Flush System	TORNADO FLUSH®
Min. Water Pressure	8 psi (Flowing)
Water Surface	9" x 6-1/4"
Trap Diameter	2-1/8"
Rough-in	12" (10" & 14" Optional)
Trap Seal	2-1/8"
Warranty	One Year Limited Warranty
Material	Vitreous China
Shipping Weight	CST672CUFGAT40: 107.5 lbs SW4736AT40: 15 lbs
Shipping Dimensions	CST672CUFGAT40 30-1/16" L x 21-9/16" W x 17-9/16" H1 x 27-1/4" H2 SW4736AT40 23-3/8" L x 17-5/8" W x 6-1/4" H

See SW4736AT40 Specification Sheet for details on included WASHLET.

INSTALLATION NOTES

Back-to-Back Toilet Installations:

TOTO recommends the use of a nationally listed, double sanitary tee-wye only, in vertical waste stacks, in accordance with the stipulations noted in the majority of nationally recognized plumbing codes.

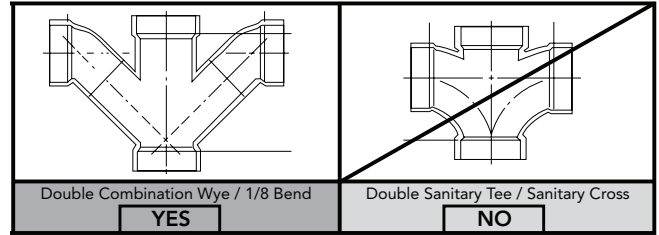

To maintain adequate wall gap between the back of the tank and wall, mount the floor flange at a nominal 12" rough-in distance.

It is recommended to have adequate supplemental flows from other water usage fixtures with a drain line slope of 2% with maximum linear runs of 60ft.

DIMENSIONS

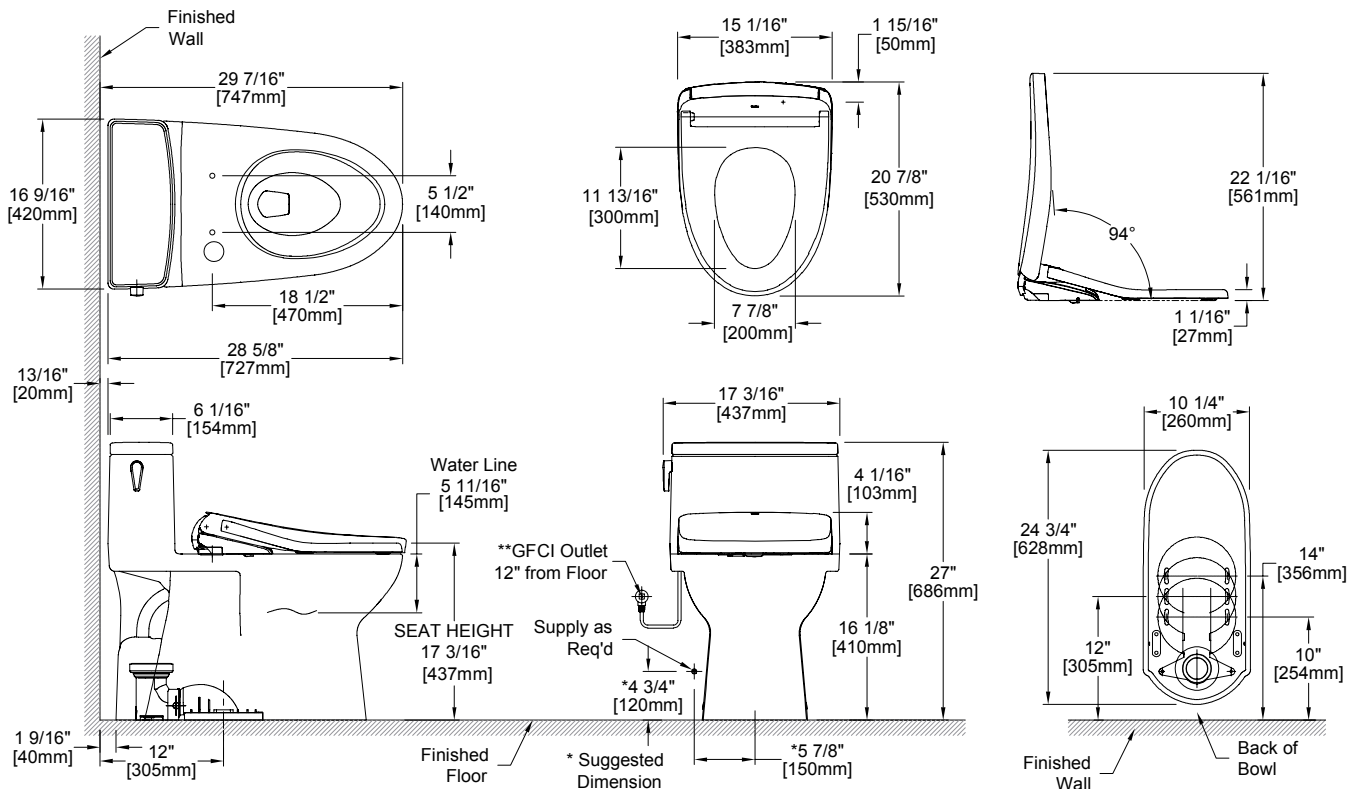

TOTO

These dimensions and specifications are subject to change without notice