

Features

- A single handle controls both on/off activation and temperature setting
- 1.2 gpm (4.5 lpm) maximum flow rate at 60 psi (4.14 bar)
- KOHLER® ceramic disc valves exceed industry longevity standards for a lifetime of durable performance
- Metal pop-up drain with lift rod and tailpiece
- Coordinates with other products in the Parallel collection

Material

- Premium metal construction for durability and reliability
- KOHLER finishes resist corrosion and tarnishing

Installation

- Single hole
- Preattached flexible supply lines simplify installation

Recommended Products/Accessories

- K-23726 Drain treatment
- K-21897 Double toilet paper holder
- K-23524 18" towel bar
- K-23525 24" towel bar
- K-23526 Towel arm
- K-23527 Vertical toilet paper holder
- K-23528 Pivoting toilet paper holder
- K-23529 Robe hook



Codes/Standards







ASME A112.18.1/CSA B125.1
 NSF/ANSI/CAN 61
 NSF/ANSI/CAN 372
 DOE - Energy Policy Act 1992
 EPA WaterSense®
 California Energy Commission (CEC)
 ADA
 ICC/ANSI A117.1
 CSA B651
 OBC
 NOM Standards
 NOM 012-CONAGUA

KOHLER® Faucet Lifetime Limited Warranty

See website for detailed warranty information.

Available Colors/Finishes

Color tiles intended for reference only.

| Color | Code | Description |
|---|------|--------------------------|
|  | CP | Polished Chrome |
|  | SN | Vibrant® Polished Nickel |
|  | AF | Vibrant® French Gold |
|  | BN | Vibrant® Brushed Nickel |
|  | BV | Vibrant® Brushed Bronze |
|  | BL | Matte Black |

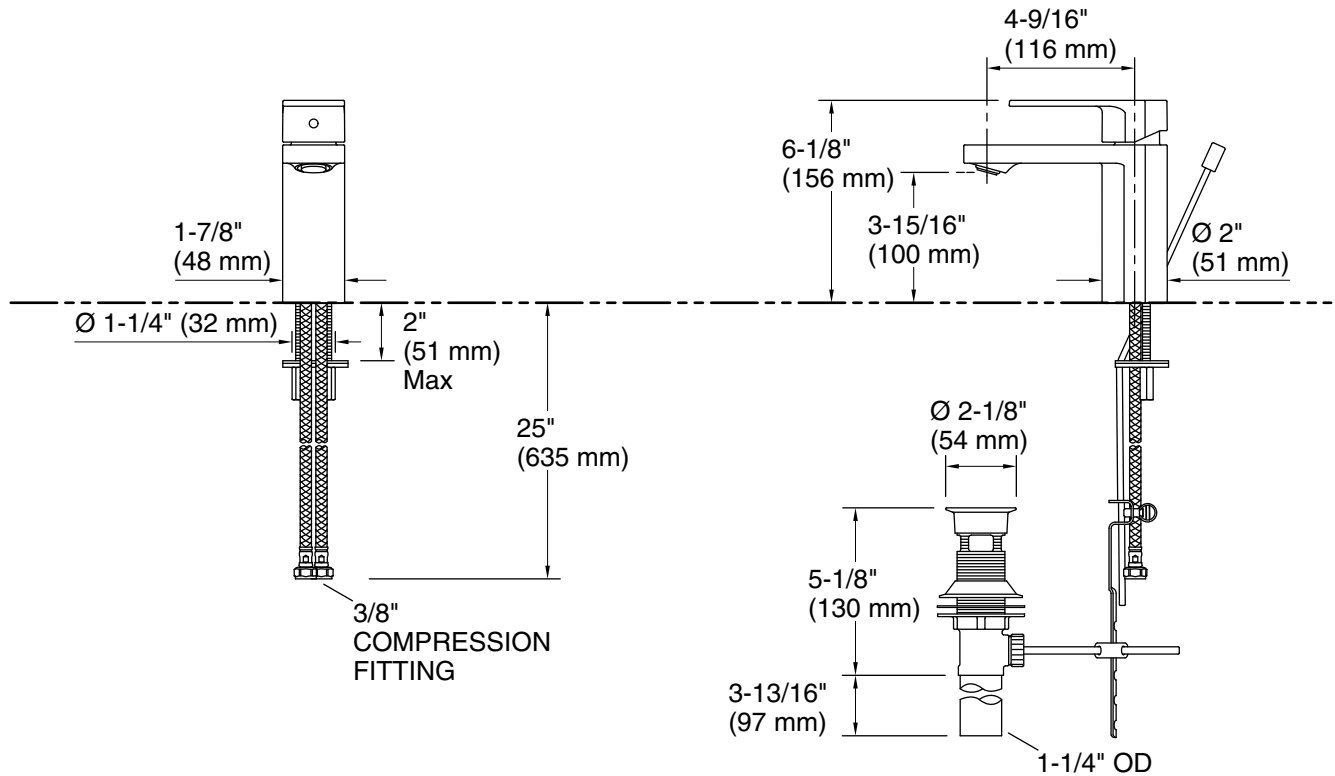

Technical Information

All product dimensions are nominal.

Faucet flow rate: 1.2 gal/min (4.5 l/min)

Drain included: Yes

Drain tailpiece included: Yes

Spout:

Spout reach: 4-1/2" (114 mm)

Notes

Install this product according to the installation instructions.

ADA compliant for handles only.

ADA, OBC, CSA B651 compliant when installed to the specific requirements of these regulations.