

# ASSEMBLY INSTRUCTIONS

## Linen Cabinet-Shutter Door

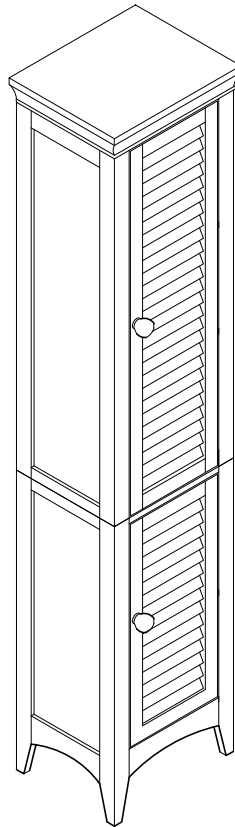

Please provide the following information when contacting for parts or questions: the name of the company you purchased from, the UPS/FedEx tracking number.

### ASSEMBLY INSTRUCTIONS-IMPORTANT

Carefully unpack & identify each component before attempting to assemble. Refer to parts list. Please take care when assembling the unit and always set the parts on a clean, soft surface. If you require any assistance with assembly, parts, please call the company you place order with or please email to: [service@eleganthf.net](mailto:service@eleganthf.net)

### INSTRUCCIONES PARA ARMAR-IMPORANT:







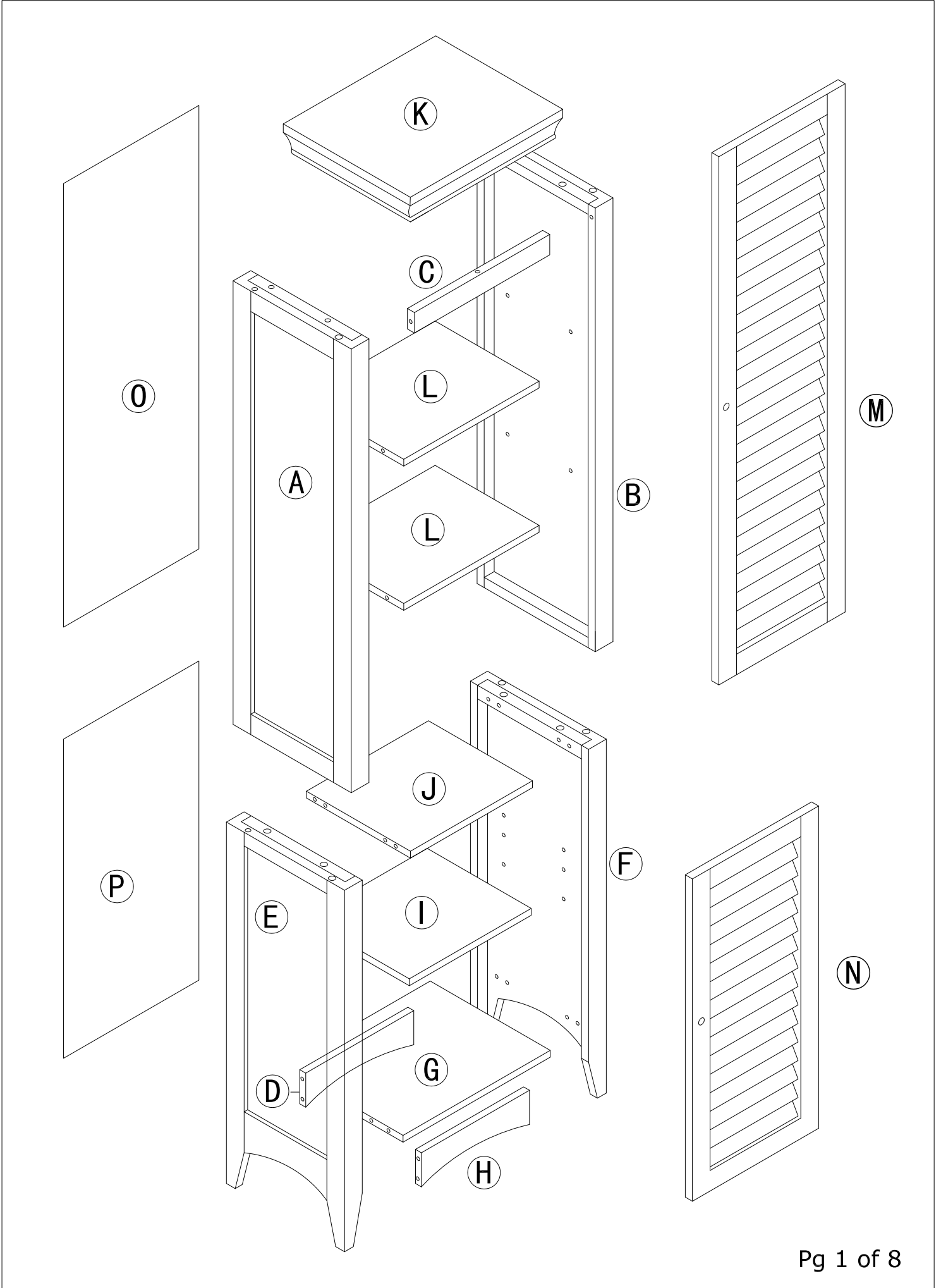



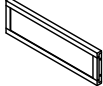

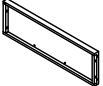



Desempaque cuidadosamente e identifique cada componente antes de tartar de empezar su ensambladura. Verifique la lista de partes. Por favor tenga cuidado cuando arme la unidad y siempre coloque las piezas sobre una superficie plana, suave y limpia. Si necesita ayuda con el armado, envíe un correo electzórico a [service@eleganthf.net](mailto:service@eleganthf.net)

### DIRECTIVES DE MONTAGE-IMPORTANT:











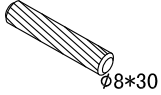
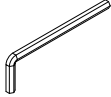

Avant de commencer l' assemblage, déballez délicatement toutes les pièces et repérez-les sur la liste des pièces. Procédez avec soins durant l' assemblage et posez toujours les pièces sur une surface proper, douce et lisse. sie vouo plait e-mail á [service@eleganthf.net](mailto:service@eleganthf.net)

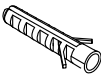
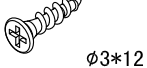

# COMPONENTS

PART	FIGURE	DESCRIPTION	QTY	PART	FIGURE	DESCRIPTION	QTY
A		TOP LEFT SIDE PANEL	1PC	I		ADJUSTABLE SHELF	1PC
B		TOP RIGHT SIDE PANEL	1PC	J		BOTTOM FIXED SHELF	1PC
C		UPPER RAIL	1PC	K		TOP PANEL	1PC
D		BOTTOM BACK RAIL	1PC	L		UPPER FIXED SHELF	2PCS
E		BOTTOM LEFT SIDE PANEL	1PC	M		LARGE DOOR	1PC
F		BOTTOM RIGHT SIDE PANEL	1PC	N		SMALL DOOR	1PC
G		BOTTOM PANEL	1PC	O		UPPER BACK PANEL	1PC
H		BOTTOM FRONT RAIL	1PC	P		BOTTOM BACK PANEL	1PC

# HARDWARE & TOOLS

PART	FIGURE	DESCRIPTION	QTY	PART	FIGURE	DESCRIPTION	QTY
1		WOODEN DOWEL	34PCS	9		ALLEN WRENCH	1 PC
2		CAM BOLT	8PCS	10		KNOB	2 PCS
3		CAM LOCK	8PCS	11		KNOB BOLT	2 PCS
4		HEX BOLT	8 PCS	12		SHELF PIN	4 PCS
5		ANCHOR	1 PC	13		SCREW	8 PCS
6		SCREW	2 PCS	14		SCREW	1 PC
7		FIX BELT	1 PC	15		SCREW	22PCS
8		WASHER	2 PCS				

## TOOL NEEDED:



**PHILIPS SCREWDRIVER REQUIRED  
- NOT INCLUDED**

## SUGGESTION:



**TWO PEOPLE FOR ASSEMBLING**



## WARNINGS:

1. DO NOT LET ANY SHARP OBJECTS TOUCH OR RUB THE SURFACE OF THE PRODUCT.
2. WHEN ASSEMBLING, DO NOT LET CHILDREN PLAY AROUND THE WORKING AREA.
3. PLEASE CONFIRM ALL PARTS ARE CORRECT BEFORE STARTING THE ASSEMBLY PROCESS.
4. DO NOT TIGHTEN ALL BOLTS AND SCREWS COMPLETELY UNTIL THE ENTIRE UNIT HAS BEEN ASSEMBLED AND SET UP.

# 1



14 PCS



4 PCS

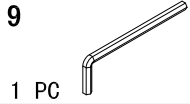

1 PC

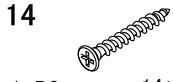

1 PC  $\phi 4*35$

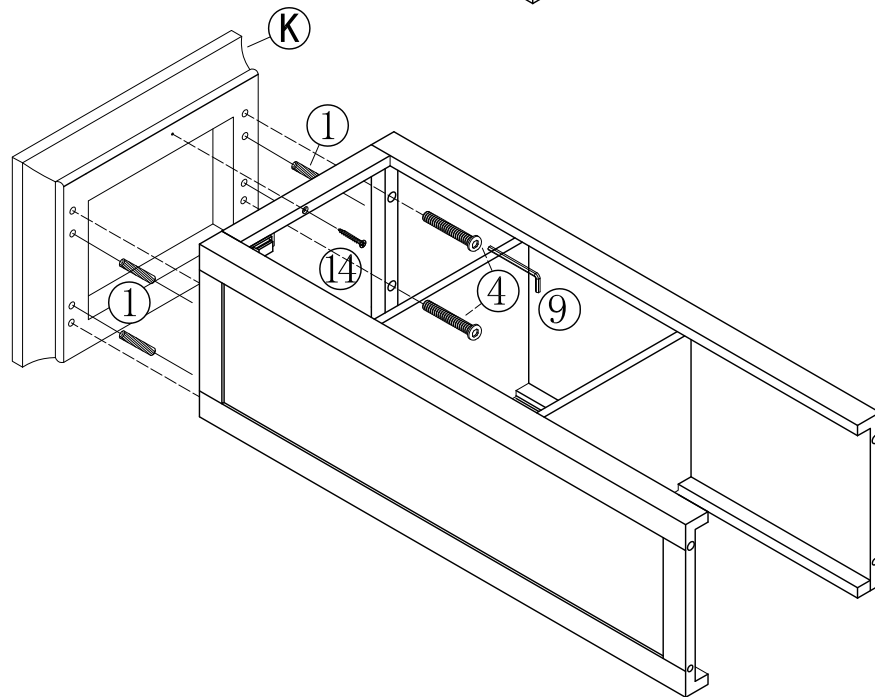
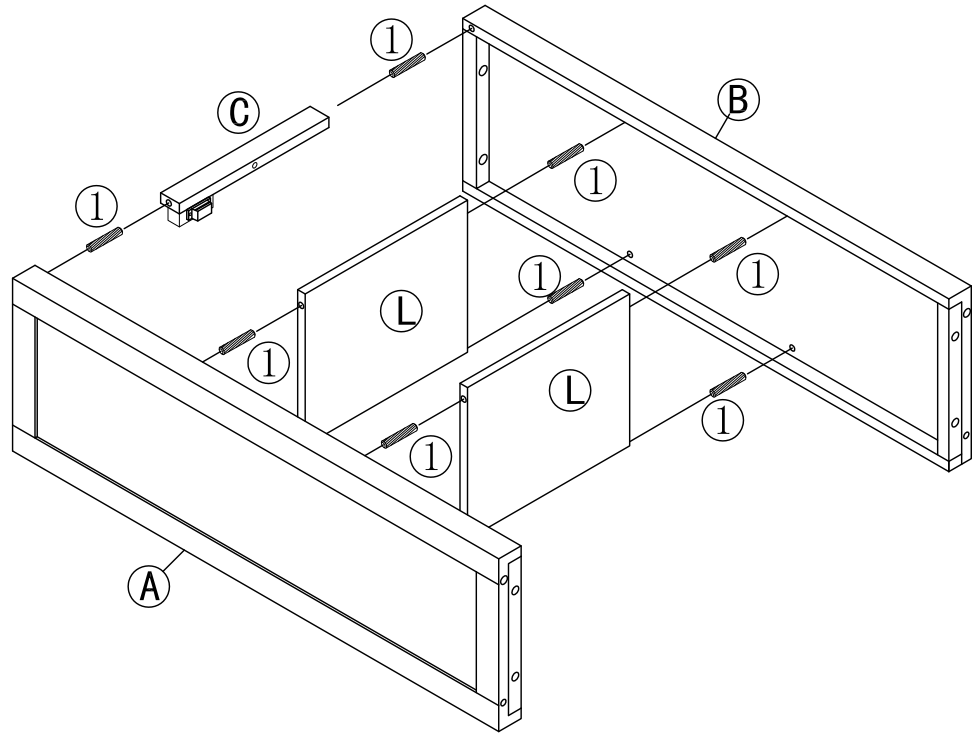

### STEP 1:

**1. Connect panels A, B, L, and rail C with dowels (1).**

**2. Insert dowels (1) to the tops of panels A & B. Attach top K to panels A & B and rail C and secure with screws (4 & 14).**

# 2



16 PCS



8 PCS

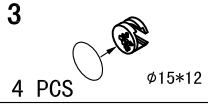

4 PCS

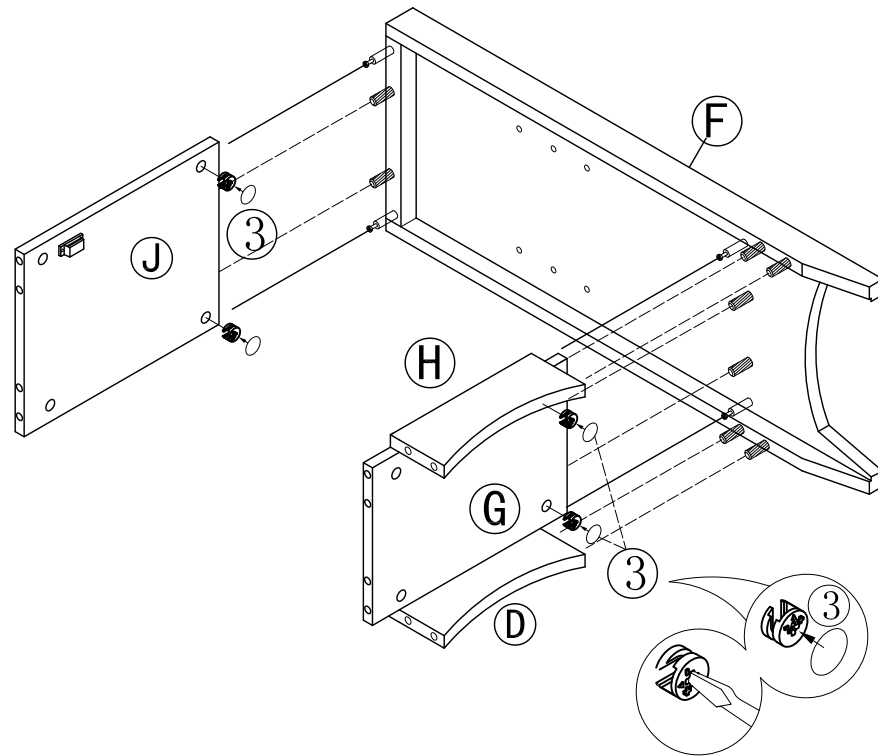
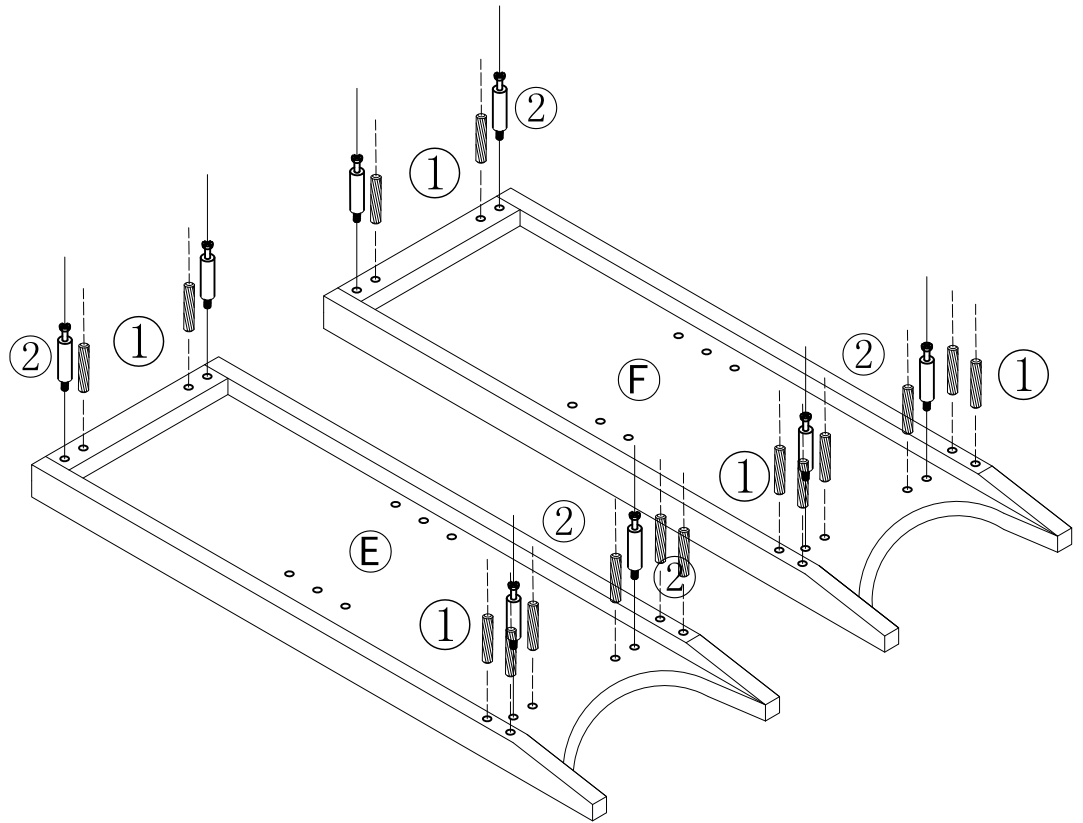

## STEP 2:

1. Attach cambolts (2) and dowels (1) to panels E & F.
2. Attach shelves G & J and rails H & D to panel F. Secure shelves G & J with camlocks (3).

# 3



4 PCS

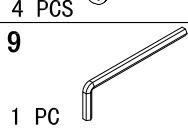

1 PC

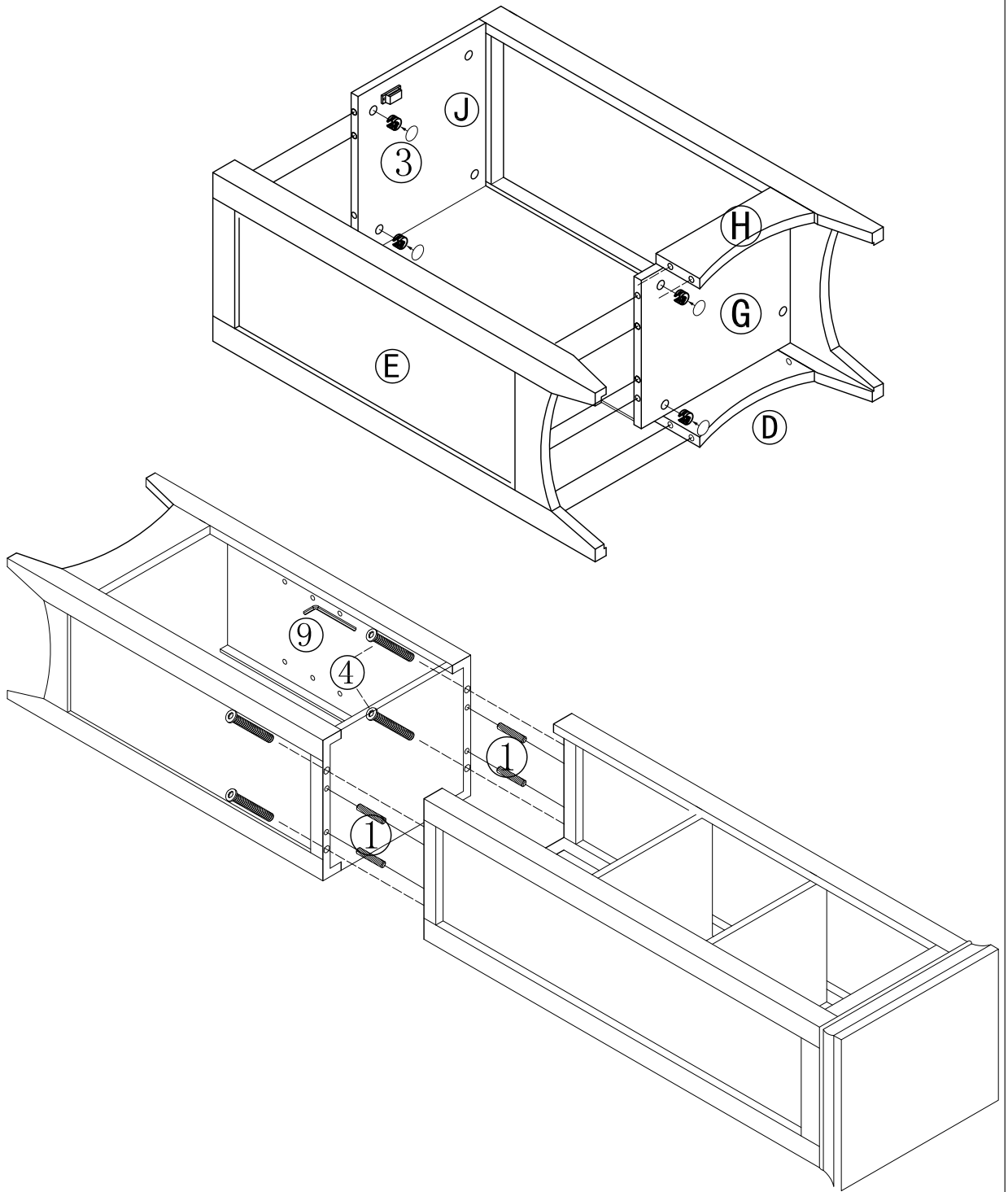

## STEP 3:

1. Attach panel E to shelves G & J and rails H & D. Secure shelves G & J with camlocks (3).
2. Insert dowels (1) to the tops of panels E & F. Connect the two halves of the towers and secure with screws (4).

# 4

10



2 PCS

11



2 PCS

12



4 PCS

13



8 PCS

ø3\*12

15



22 PCS

ø3\*12 D=7

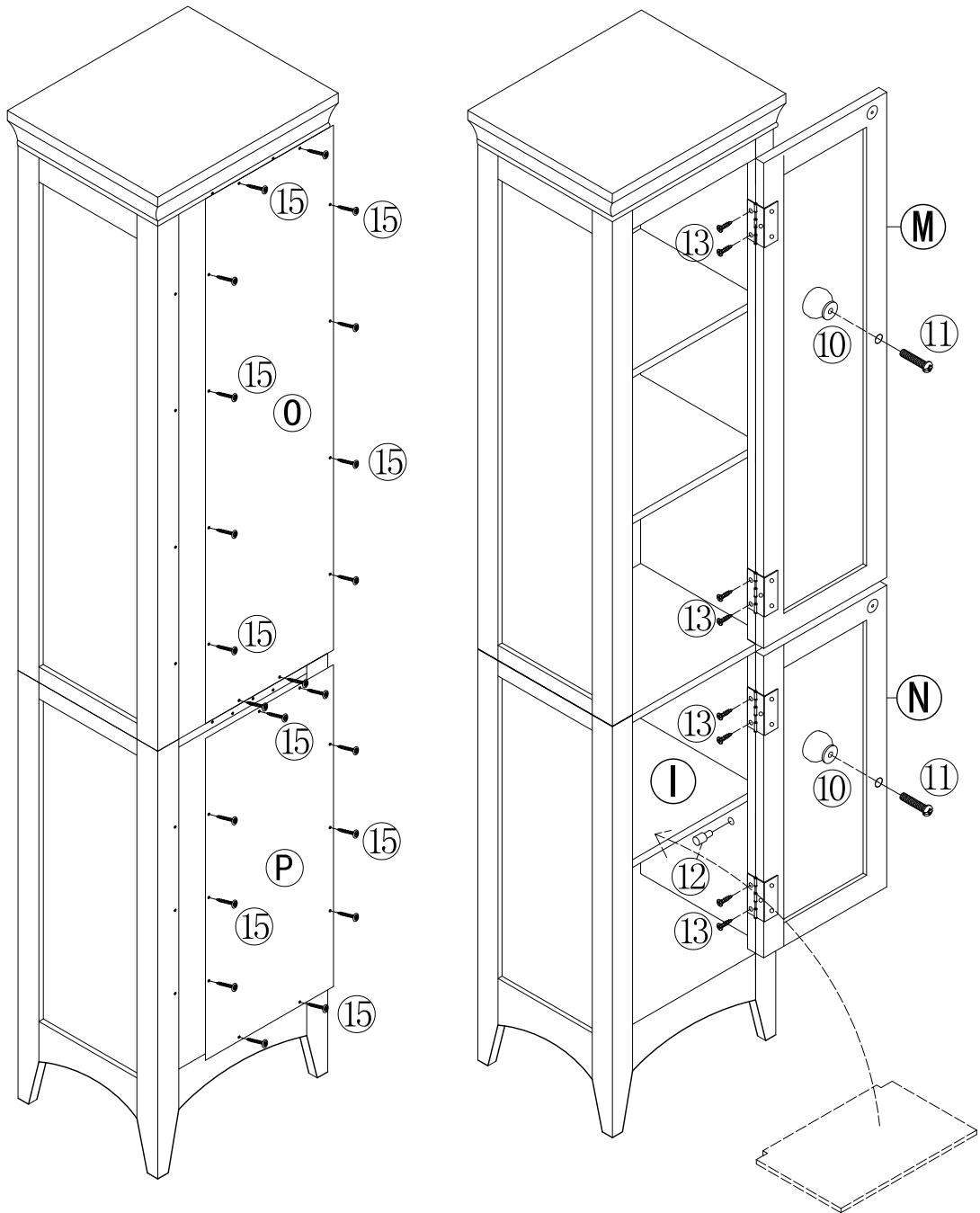

## STEP 4:

1. Attach back panels O & P with screws (15).
2. Lay the tower on its side to attach doors M & N with screws (13).
3. Attach knobs (10) to the doors with screw (11).
4. Insert shelf pins (12) and rest adjustable shelf I on the shelf pins.



# 5

5



1 PC

6



2 PCS

φ4\*25

7



1 PC

8



2 PCS

