

Parts:

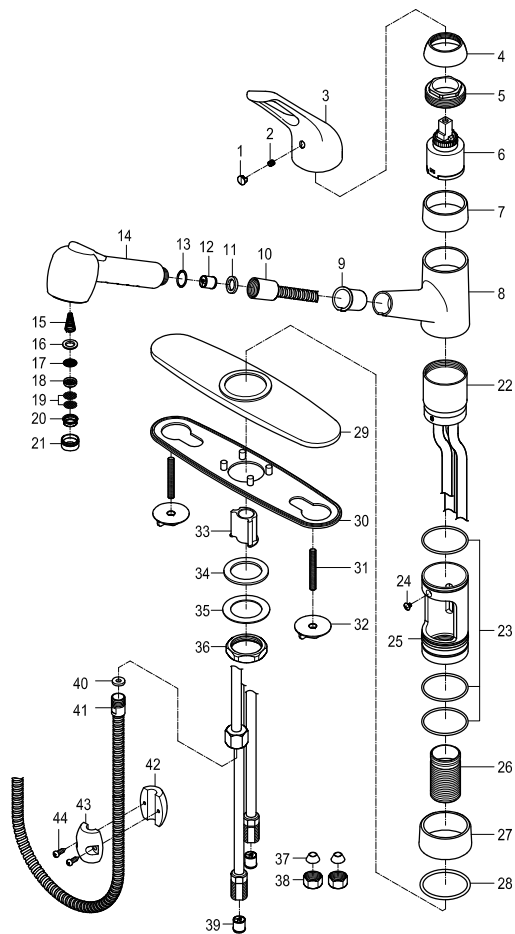

Replacement Parts:

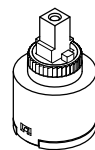

Cartridge: KSRP3891C

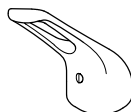

Handle: GSCH881NCL

KINGSTON

KITCHEN & BATH

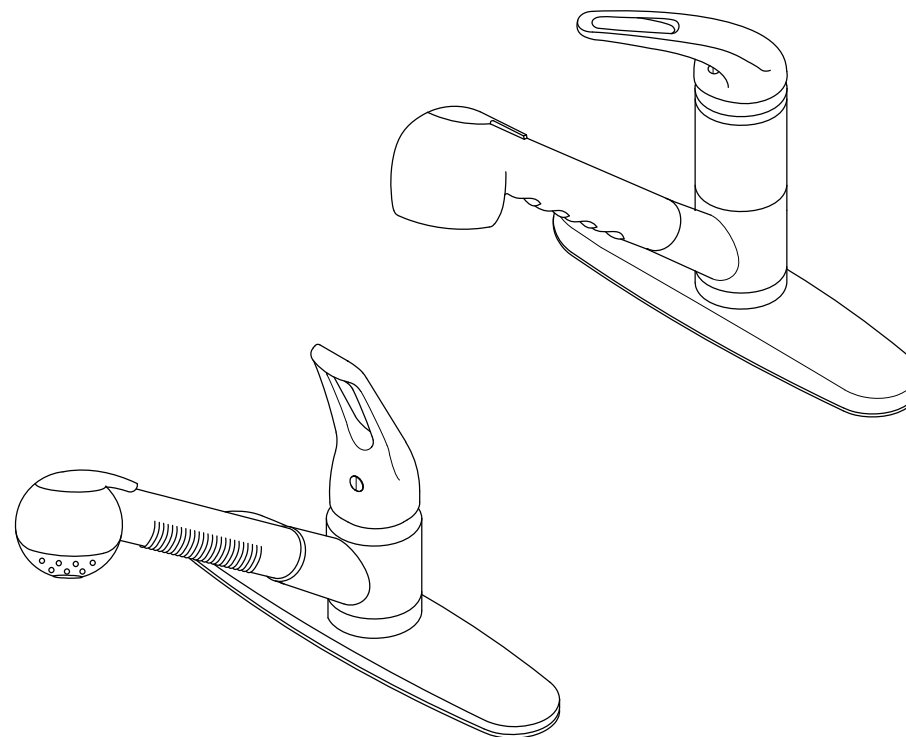

CARE AND MAINTENANCE OF YOUR FAUCET

Your Kingston Brass faucet has been finished to the most strict standards; however, due to the high content of minerals in the water, your finish may appear dull and tarnished after time. These are some do's and don'ts to maintain the luster on your faucet for many years to come.

DO

1. Use a silicon based caulking when installing.
2. Clean your faucet with only a mild soap and water solution.
3. Dry your faucet after using it.
4. Give it a coat of Carnauba Wax periodically.

DON'T

1. Use plumbers putty when installing the faucet.
2. Use any abrasive cleaning agents.

It may seem like a very simple and short list but it is that simple to maintain your faucet, looking shiny and new.

If your faucet is already looking somewhat dull and tarnished, before replacing it, try cleaning it with a 50/50 solution of vinegar and water, you may need to soak some rags and wrap around those stubborn areas, leave overnight and rinse completely in the morning, apply Carnauba wax once you have removed the mineral deposits.

Parts:

Bolt & Lock Nut	Cone Washer & Coupling Nut	Washer & Lock Nut	Counter Weight & Screw
2 Pcs	2 Pcs	1 Pc	1 Set

NOTICE

Failure to follow all directions may cause leaks which may result in water damage

www.kingstonbrass.com

TOLL-FREE CUSTOMER SERVICE: 1-877-2-KBRASS
 TECHNICAL SUPPORT E-mail: service@kingstonbrass.com
 12775 Reservoir Street, Chino, CA 91710

KINGSTON

KITCHEN & BATH

INSTALLATION INSTRUCTIONS

Pull-Out Kitchen Faucet

BEFORE BEGINNING INSTALLATION:

1. Flush plumbing lines to clear any debris.
2. Shut off both supply lines after flushing.

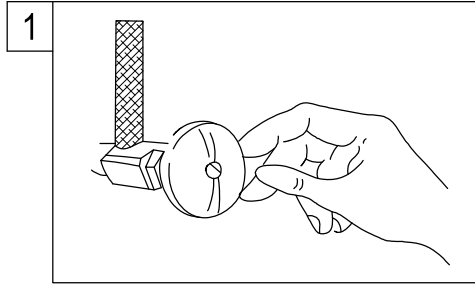

1. Shut off hot and cold water supply under sink. Plug sink drain with cloth to avoid losing small parts. Remove old faucet.

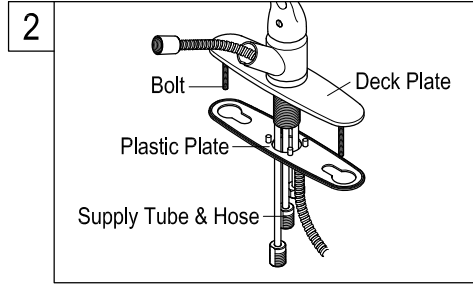

2. After applying a bead of silicon based caulking to the underside of the plastic plate, set at the desired location.

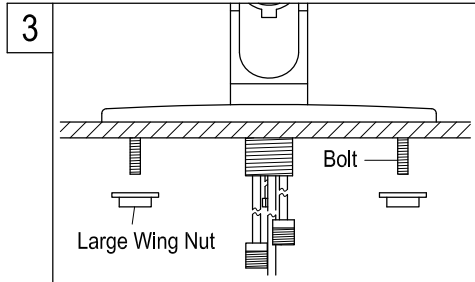

3. Insert faucet shank through center hole and secure by threading large wing nuts on the screws that secure base plate. Insert washers and thread locknut on center shank of the faucet, use a basin wrench to tighten.

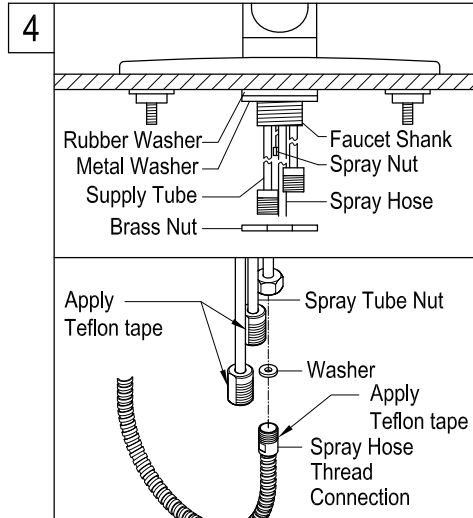

4. Insert spray head hose from the top, male thread side first, moving the spout to the right or left side will facilitate insertion of the hose.

Apply Teflon tape to the threads and place rubber washer on bottom end of hose and thread to spray tube nut, tighten using basin or adjustable wrench, gently bending inlet lines will make it easier to thread the spray hose.

Need Tools:

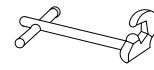

Basin Wrench



Adjustable Wrench



Teflon Tape

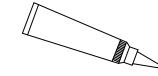

Silicone Sealant

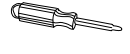

Screwdriver

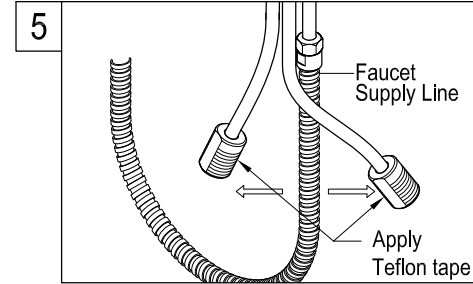

5. Apply Teflon tape and thread supply lines to inlet lines, tighten using adjustable wrench.

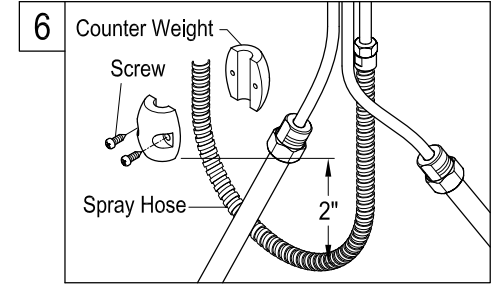

6. Install counterweight set on the spray hose, place at least 2" higher than the bend on the hose, attach with screws tightly.

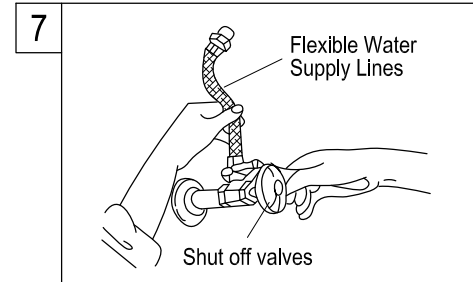

7. Apply Teflon tape on stop valves and attach supply lines, with the faucet closed turn on water supply and check for leaks.

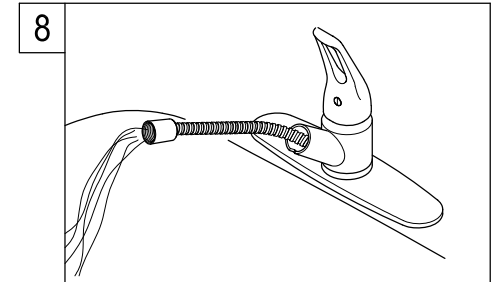

8. Pull the spray hose through the spout and hold securely, turn on the faucet and let the water run for at least 1 minute, this will clear any debris from the line.

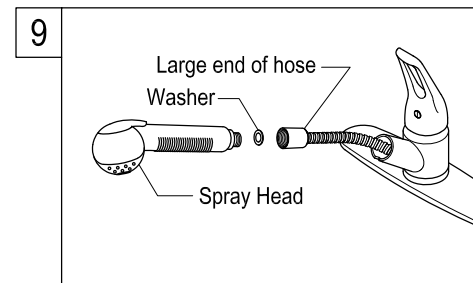

9. Insert washer and attach spray head, insert spray head onto faucet body.

Warning!!!

- Do not over-tighten nut during installation.
- Over-tighten may crack the valve and cause severe leak.