







ITEM: 5961-90251-02 5/0 Panel Headboard  
 5961-90251-89 5/0 Panel Headboard  
 5961-90252-02 5/0 Panel Footboard  
 5961-90252-89 5/0 Panel Footboard  
 5961-90267-02 6/0-6/6 Panel Headboard  
 5961-90267-89 6/0-6/6 Panel Headboard  
 5961-90268-02 6/0-6/6 Panel Footboard  
 5961-90268-89 6/0-6/6 Panel Footboard  
 5961-90253-02 5/0-6/6 Rails  
 5961-90253-89 5/0-6/6 Rails  
 5961-90263-02 6/0 Rails  
 5961-90263-89 6/0 Rails

Thank you for purchasing this quality product. Be sure to unpack carefully looking for small parts which may have come loose during shipment.  
 Read all instruction and study the drawing carefully before starting the assembly process .

HARDWARE PACK				
NO.	DRAWING	DESCRIPTION	SIZE	Q'TY
A		Open Wrench	5/16"	1PC
B		Nut	5/16"	8PCS
C		Curved Washer	5/16"	8PCS
D		Threaded Rod	5/16*100mm	8PCS
E		Screw	8*32mm	20PCS (FOR 6/6 & 6/0 BED) 16PCS (FOR 5/0 BED)

PART LIST			
NO.	DRAWING	DESCRIPTION	Q'TY
1		Headboard	1PC
2		Rails	2PCS
3		Footboard	1PC
4		Slats	5PCS (FOR 6/6 & 6/0 BED) 4PCS (FOR 5/0 BED)
5		Support leg	5PCS (FOR 6/6 & 6/0 BED) 4PCS (FOR 5/0 BED)

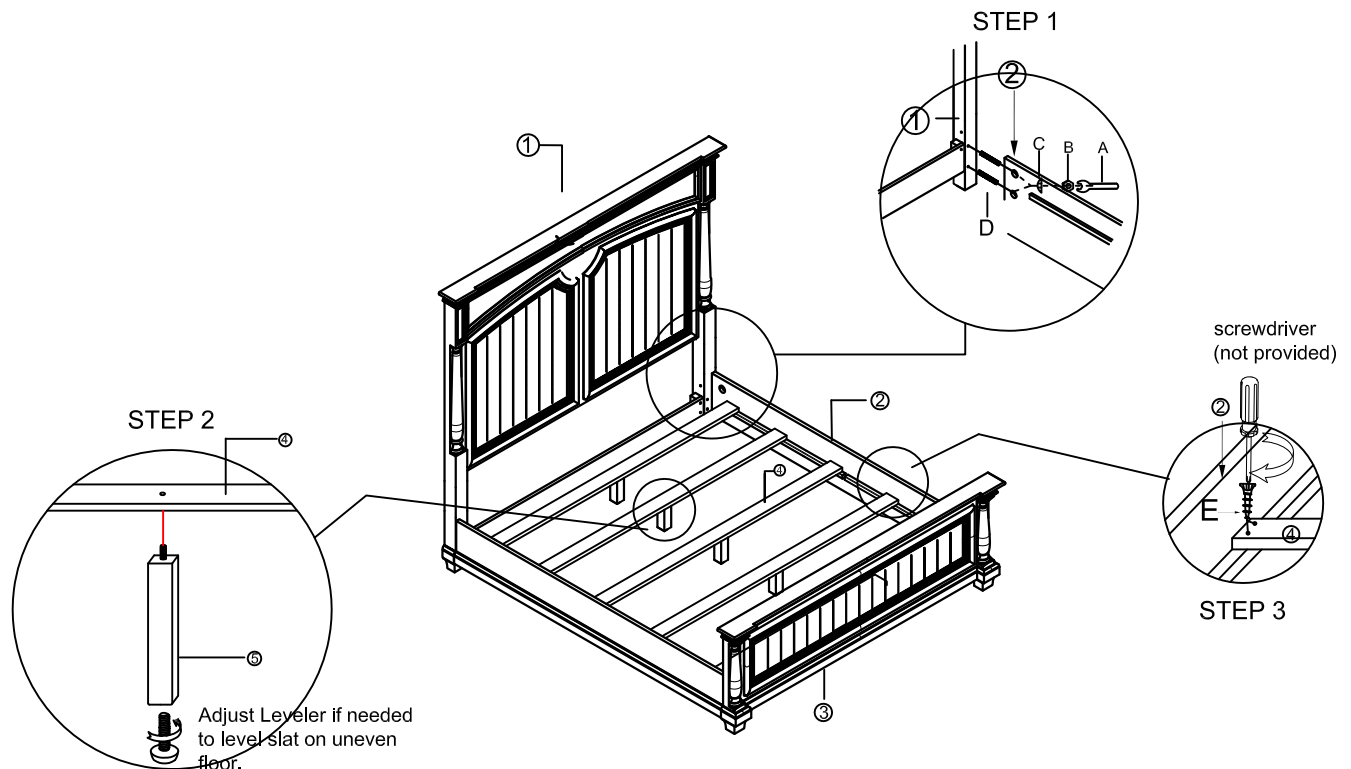

**Step 1:** Attach Rails (2) to Headboard (1) and Footboard (3) by using Threaded Rods (D), Curved Washers (C), Lock Washers (F), Flat Washers (G) and Nuts (B), tighten them with Open Wrench (A) .

**Step 2:** Attach support legs (5) to slats (4).

**Step 3:** Attach slats (4) to the rails (2) and tighten them by using Phillips head screwdriver.